

SERIES: VFM-03 | DESCRIPTION: DC POWER LINE FILTER
FEATURES

- 3 A maximum filter
- frequency attenuation to 20 dB
- available in DIP, Chassis and DIN rail mounting options
- optimized for reducing EMI noise on DC power line

SPECIFICATIONS

| parameter | conditions/description | min | typ | max | units |
|-----------------------|------------------------|-----|-----|-------|-------|
| input voltage | | 0 | | 80 | Vdc |
| input current | | | | 3 | A |
| noise attenuation | at 150 kHz ~ 1 GHz | | 20 | | dB |
| isolation voltage | | | | 1,500 | Vdc |
| RoHS | yes | | | | |
| operating temperature | | -40 | | 85 | °C |
| storage temperature | | -55 | | 125 | °C |
| storage humidity | non-condensing | 5 | | 95 | % |
| case temperature rise | at nominal current | | | 40 | °C |

Notes: 1. All specifications are measured at T_a=25°C, humidity < 75%, unless otherwise specified.

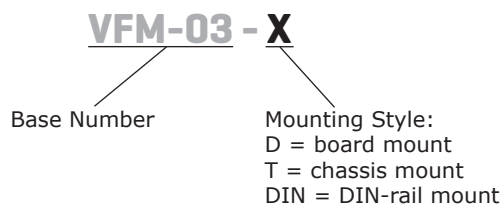
PART NUMBER KEY

SOLDERABILITY²

| parameter | conditions/description | min | typ | max | units |
|----------------|----------------------------|-----|-----|-----|-------|
| hand soldering | for 3~5 seconds | 350 | 360 | 370 | °C |
| wave soldering | see wave soldering profile | | | 260 | °C |

Note: 2. For board mount models only.

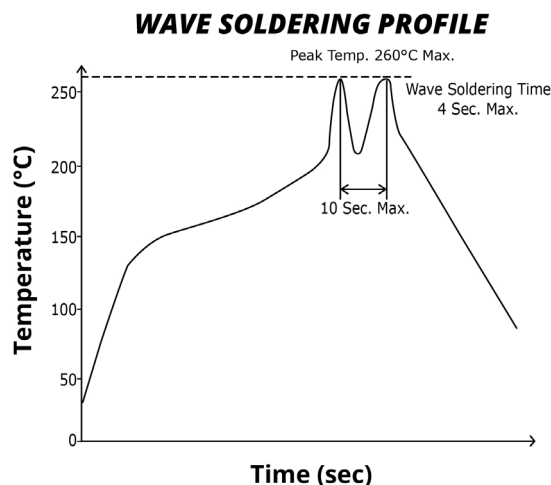

MECHANICAL

| parameter | conditions/description | min | typ | max | units |
|---------------|--|-----|----------------|-----|-------|
| dimensions | board mount: 25.40 x 25.40 x 11.70 [1.000 x 1.000 x 0.461 inch] chassis mount: 76.00 x 31.50 x 21.20 [2.992 x 1.240 x 0.835 inch] DIN-Rail mount: 76.00 x 31.50 x 25.80 [2.992 x 1.240 x 1.016 inch] | | | | mm |
| case material | aluminum alloy | | | | |
| weight | board mount chassis mount DIN-rail mount | | 15 35 55 | | g |

MECHANICAL DRAWING (BOARD MOUNT)

units: mm [inch]
tolerance: ±0.50[±0.020]
pin diameter tolerance: ±0.10[±0.004]
pin height tolerance: ±0.50[±0.020]

| PIN CONNECTIONS | |
|-----------------|----------|
| PIN | Function |
| 1 | +Vin |
| 2 | -Vin |
| 3 | GND |
| 4 | -Vout |
| 5 | +Vout |

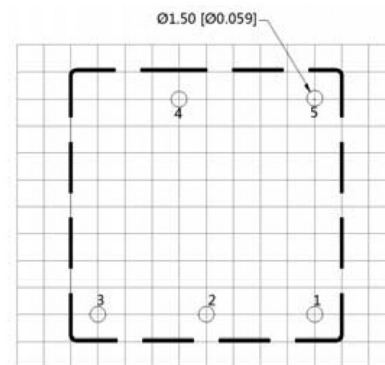
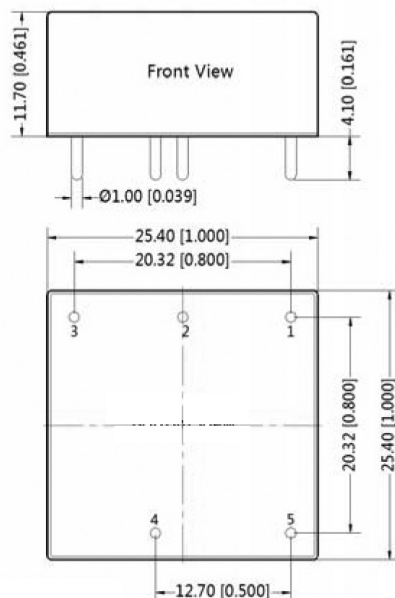

Note: Grid 2.54*2.54mm
Recommended PCB Layout
Top View

MECHANICAL DRAWING (CHASSIS MOUNT)

units: mm [inch]
tolerance: ±0.50[±0.020]

wire range: 24~12 AWG
tightening torque: 0.4 N*m max

| PIN CONNECTIONS | |
|-----------------|----------|
| PIN | Function |
| 1 | +Vin |
| 2 | -Vin |
| 3 | GND |
| 4 | -Vout |
| 5 | +Vout |

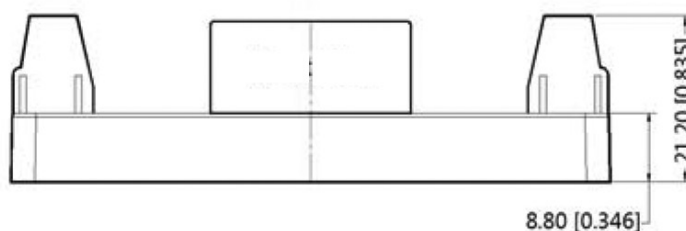
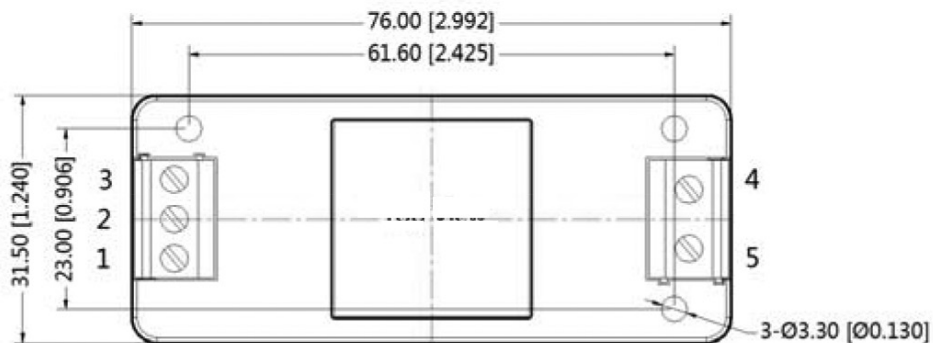

MECHANICAL DRAWING (DIN-RAIL MOUNT)

units: mm [inch]
tolerance: ±0.50[±0.020]

installed on DIN rail TS35
wire range: 24~12 AWG
tightening torque: 0.4 N*m max

| PIN CONNECTIONS | |
|-----------------|----------|
| PIN | Function |
| 1 | +Vin |
| 2 | -Vin |
| 3 | GND |
| 4 | -Vout |
| 5 | +Vout |

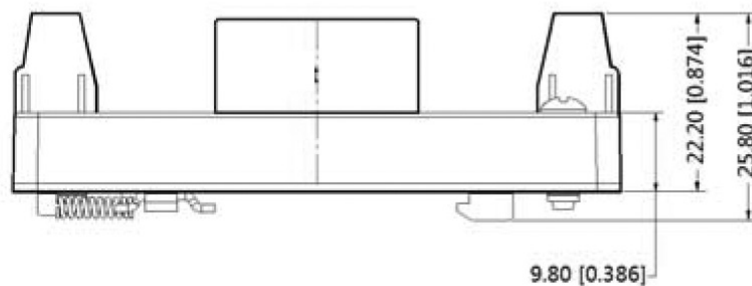
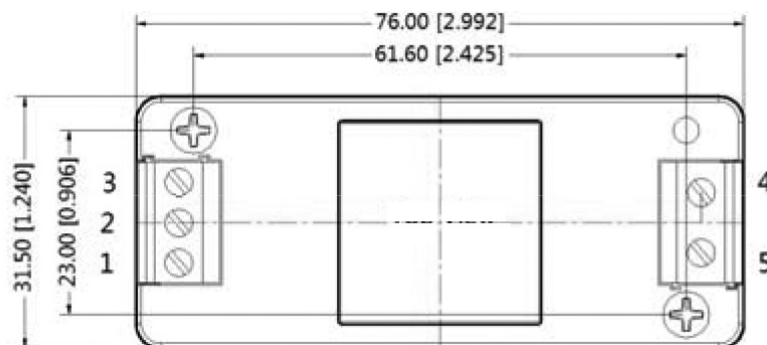

APPLICATION CIRCUIT

Figure 1
Application Circuit

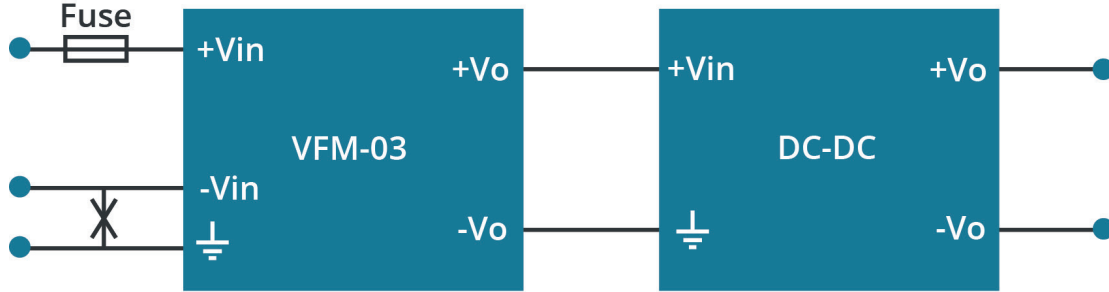
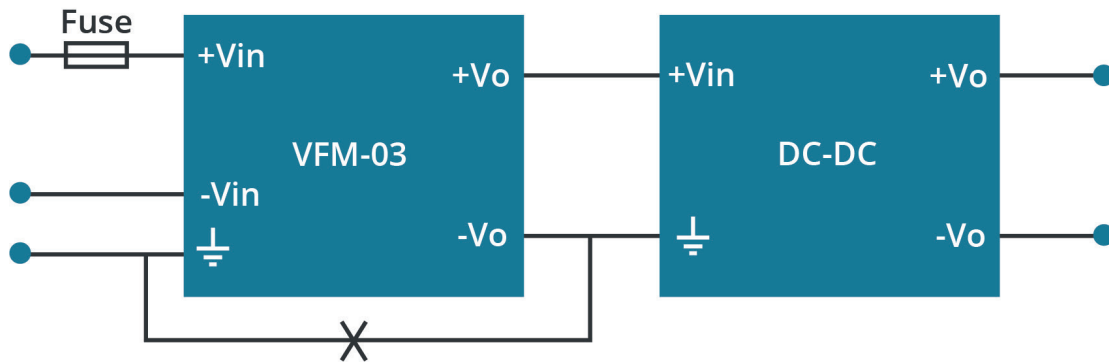

Figure 2
Non-supported Application for Module



REVISION HISTORY

| rev. | description | date |
|------|--|------------|
| 1.0 | initial release | 12/17/2018 |
| 1.01 | circuit figures updated, packaging removed | 01/25/2022 |

The revision history provided is for informational purposes only and is believed to be accurate.



CUI INC

a bel group

Headquarters
20050 SW 112th Ave.
Tualatin, OR 97062
800.275.4899

Fax 503.612.2383
cui.com
techsupport@cui.com

CUI offers a two (2) year limited warranty. Complete warranty information is listed on our website.

CUI reserves the right to make changes to the product at any time without notice. Information provided by CUI is believed to be accurate and reliable. However, no responsibility is assumed by CUI for its use, nor for any infringements of patents or other rights of third parties which may result from its use.

CUI products are not authorized or warranted for use as critical components in equipment that requires an extremely high level of reliability. A critical component is any component of a life support device or system whose failure to perform can be reasonably expected to cause the failure of the life support device or system, or to affect its safety or effectiveness.