

SF2253E

**2655 MHz
SAW Filter**

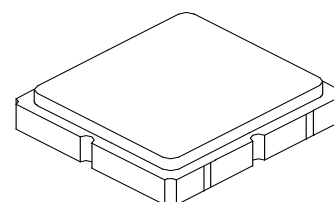

SM3030-6

- **Low-loss RF SAW Filter**
- **Surface Mount 3.0 x 3.0 x 1.3 mm Package**
- **Complies with Directive 2002/95/EC (RoHS)**
- **Moisture Sensitivity Level: 1**

Absolute Maximum Ratings

Rating	Value	Units
Input Power Level	15	dBm
DC Voltage on any Non-ground Terminal	12	V
Operating Temperature Range	-40 to +85	°C
Storage Temperature Range in Tape and Reel	-40 to +85	°C
Solder Reflow Temperature, 10 seconds, 5 cycles maximum	220	°C

Electrical Characteristics

Characteristic	Sym	Notes	Min	Typ	Max	Units
Center Frequency	F_C			2655		MHz
Insertion Loss, 2620 to 2690 MHz	IL			2.2	3.6	dB
Amplitude Ripple, 2620 to 2690 MHz				0.7	2.2	dB _{p-p}
Group Delay Ripple, 2620 to 2690 MHz				7	35	ns
VSWR, 2620 to 2690 MHz				1.9	2.5	
Attenuation Referenced to 0 dB:						
300 to 500 MHz			20	36		dB
500 to 2450 MHz			22	30		
2450 to 2550 MHz			25	36		
2745 to 3000 MHz			15	37		
Source Impedance	Z_S			50		Ω
Load Impedance	Z_L			50		
Case Style	SM3030-6 3.0 x 3.0 mm Nominal Footprint					
Lid Symbolization (Y=year, WW=week, S=shift) dot=pin 1 indicator	995, <u>YWWS</u>					
Standard Reel Quantity	Reel Size 7 Inch					500 Pieces/Reel
	Reel Size 13 Inch					3000 Pieces/Reel

 **CAUTION: Electrostatic Sensitive Device. Observe precautions for handling.**

NOTES:

1. The design, manufacturing process, and specifications of this device are subject to change.
2. US or International patents may apply.
3. RoHS compliant from the first date of manufacture.

Filter Test Circuit

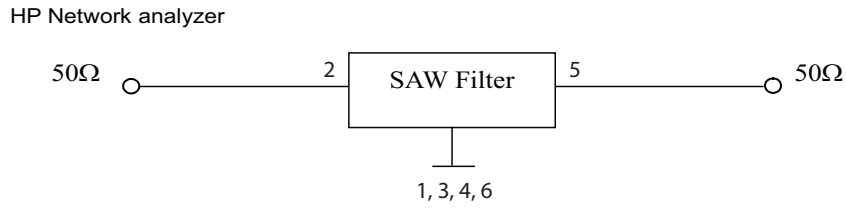

Connection	Terminals
Input	2
Output	5
Ground	1, 3, 4, 6

Frequency Response:

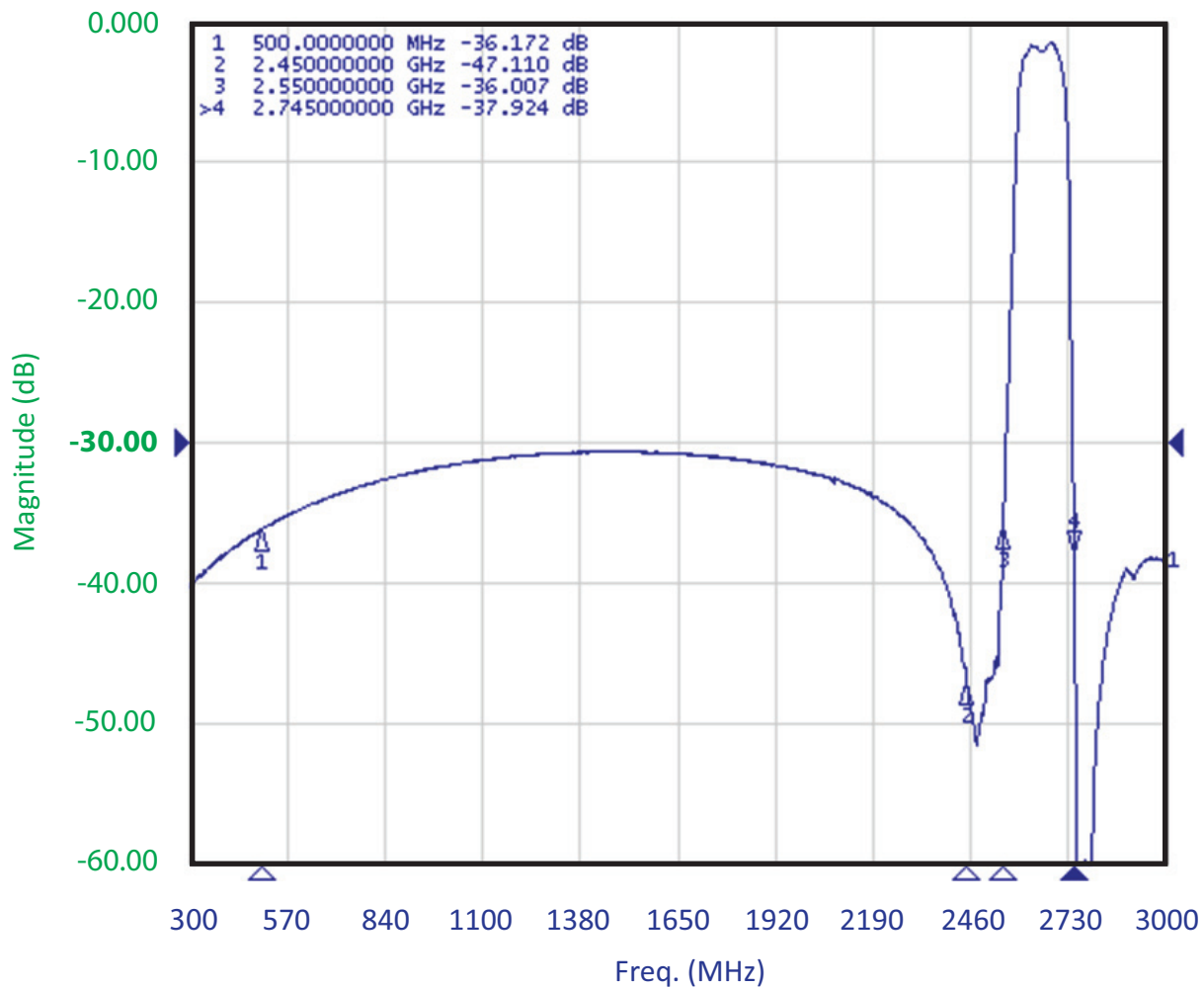

S11

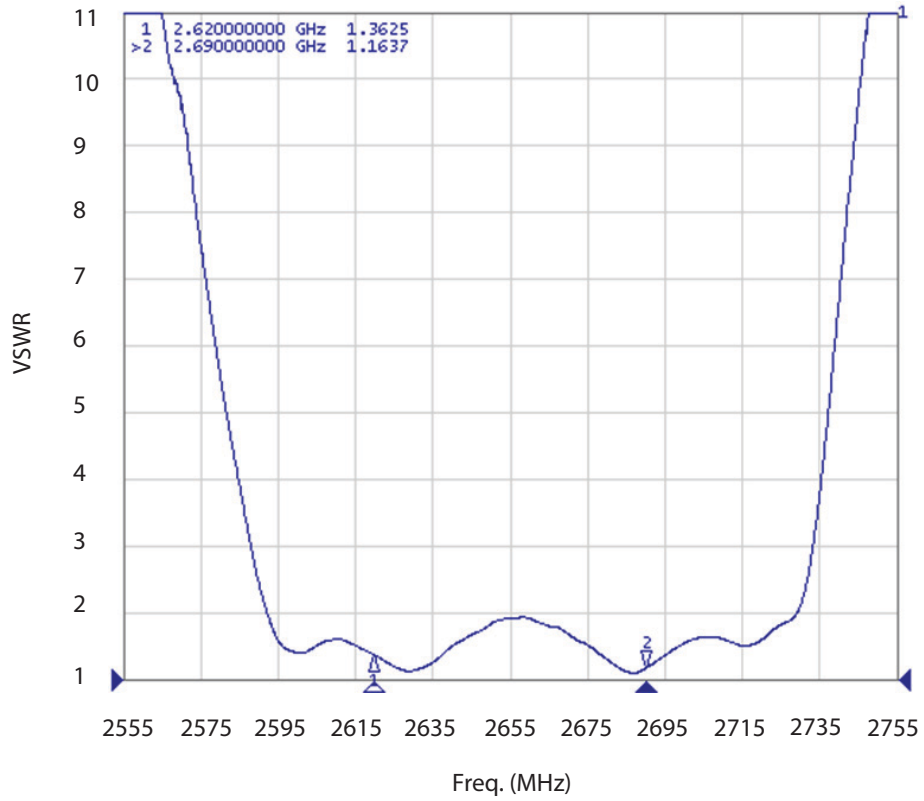

S22

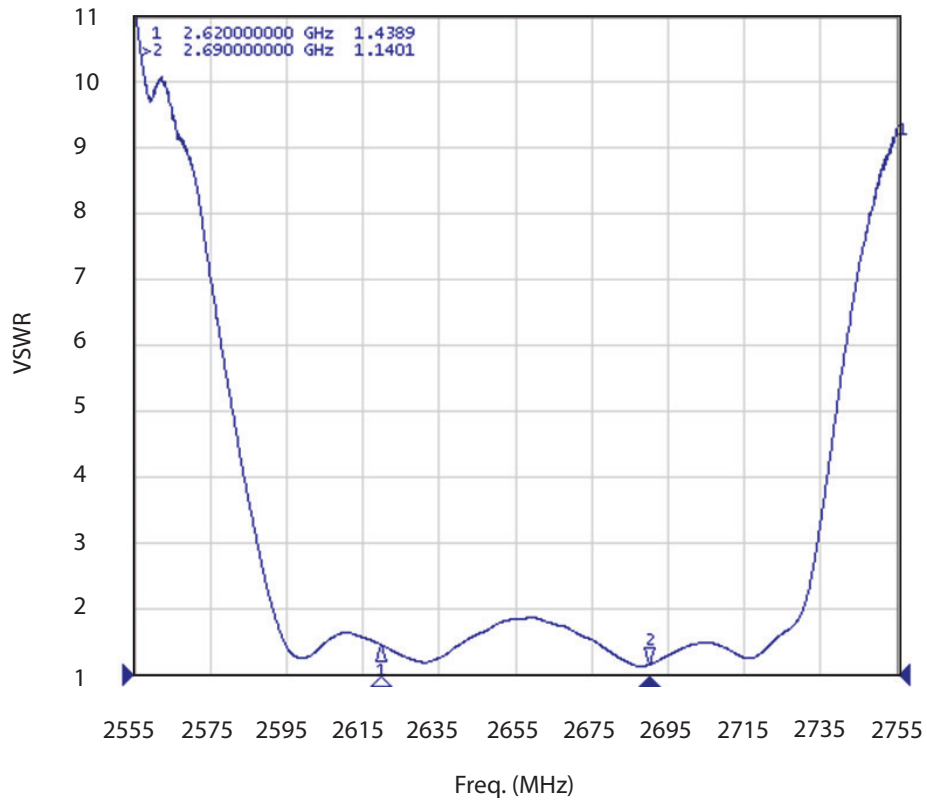

Pass Band Response

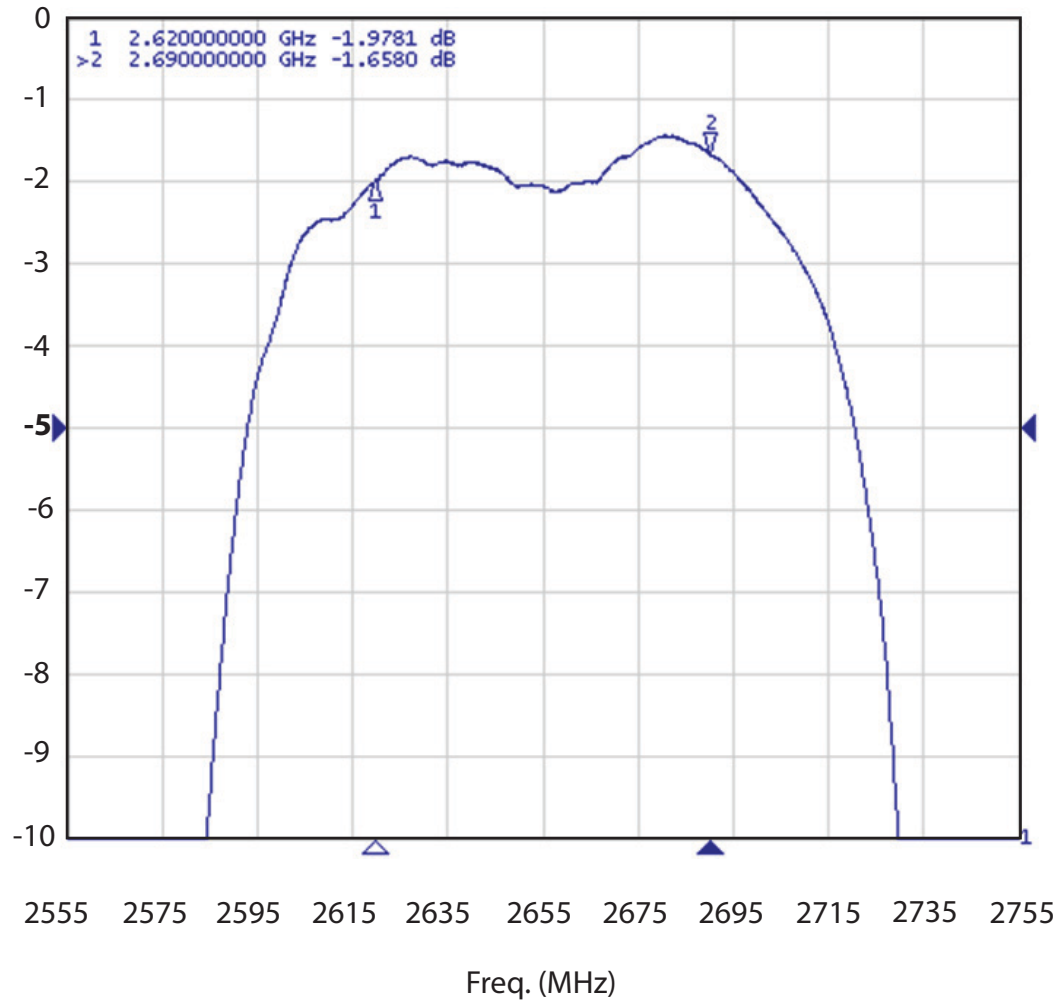

SM3030-6 Case

6-Terminal Ceramic Surface-Mount Case 3.0 X 3.0 mm Nominal Footprint

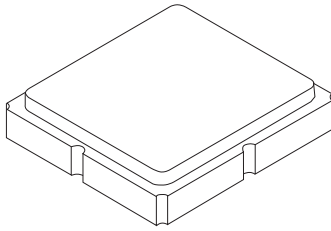

PCB Footprint Top View

Case and PCB Footprint Dimensions

Dimension	mm			Inches		
	Min	Nom	Max	Min	Nom	Max
A	2.87	3.00	3.13	0.113	0.118	0.123
B	2.87	3.00	3.13	0.113	0.118	0.123
C	1.12	1.25	1.4	0.044	0.049	0.050
D	0.77	0.90	1.03	0.030	0.035	0.040
E	2.67	2.50	2.93	0.105	0.090	0.115
F	1.47	1.60	1.73	0.058	0.063	0.068
G	0.72	0.85	0.98	0.028	0.033	0.038
H	1.37	1.50	1.63	0.054	0.059	0.064
I	0.47	0.60	0.73	0.019	0.024	0.029
J	1.17	1.30	1.43	0.046	0.051	0.056
K		3.20			0.126	
L		1.70			0.067	
M		1.05			0.041	
N		0.81			0.032	
O		0.38			0.015	

Case Materials

Materials	
Solder Pad Plating	0.3 to 1.0 μ m Gold over 1.27 to 8.89 μ m Nickel
Lid Plating	2.0 to 3.0 μ m Nickel
Body	Al ₂ O ₃ Ceramic

TOP VIEW

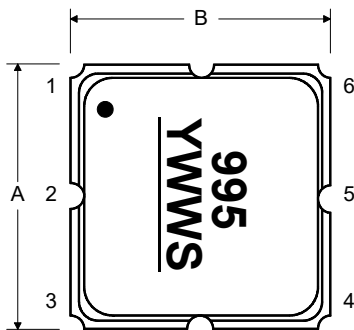

BOTTOM VIEW

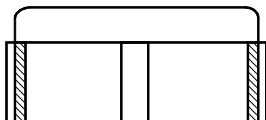
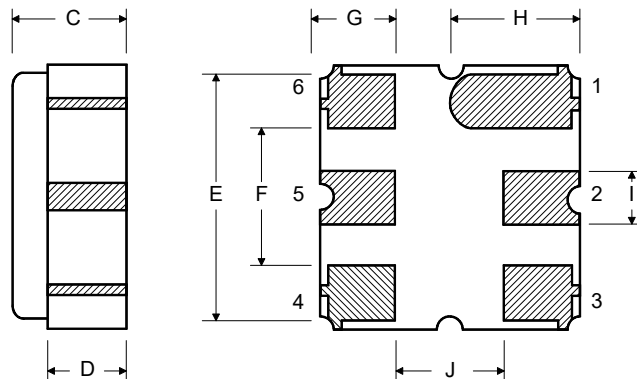

Tape and Reel Specifications

Tape and Reel Standard per ANSI/EIA481

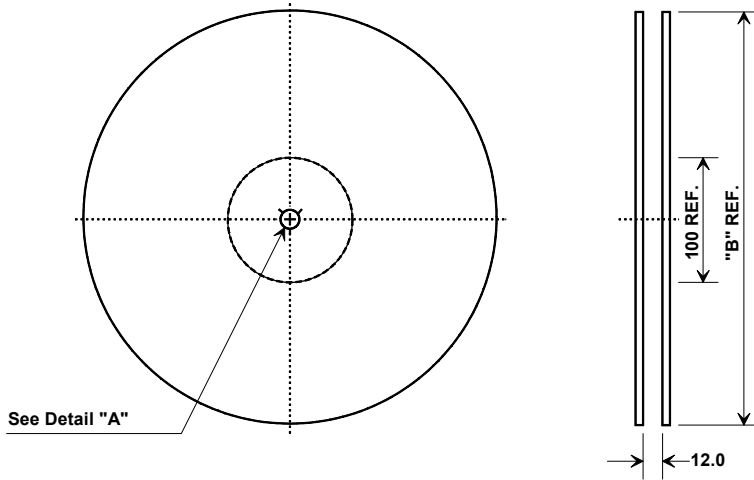

"B"		Quantity Per Reel
Inches	millimeters	
7	178	500
13	330	3000

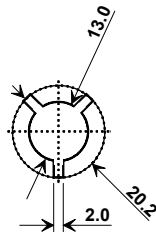

COMPONENT ORIENTATION and DIMENSIONS

Carrier Tape Dimensions	
Ao	3.35 mm
Bo	3.35 mm
Ko	1.40 mm
Pitch	8.0 mm
W	12.0 mm

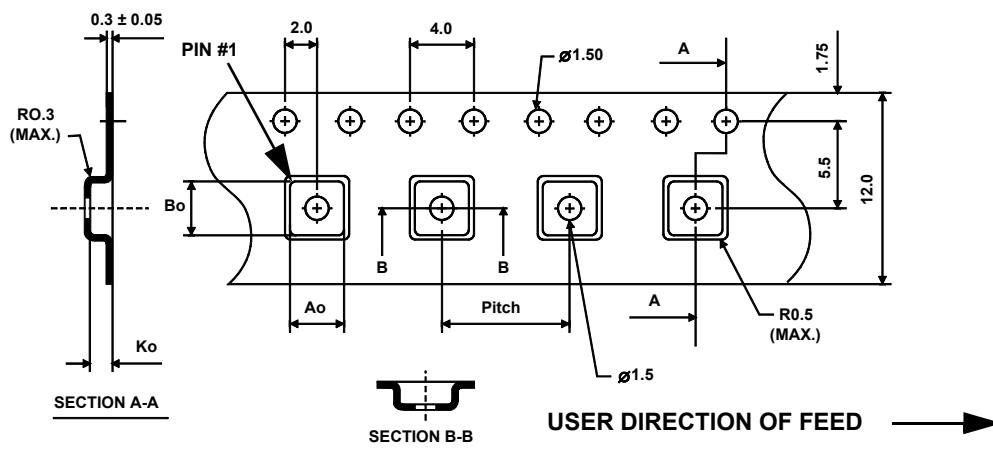

Recommended Reflow Profile

1. Preheating shall be fixed at 150~180° for 60~90 seconds.
2. Ascending time to preheating temperature 150° shall be 30 seconds min.
3. Heating shall be fixed at 220°C for 50~80 seconds and at 260°C peak (10 seconds.)
4. Time: 5 times maximum

