

10/100BASE-T DUAL PORT TRANSFORMER MODULES

Industrial grade



- Compliant with IEEE 802.3 standards
- 350µH OCL with 8mA DC bias at 100KHz 100mV
- Lead finish: Pure tin
- Moisture Sensitivity Level: 1

Electrical Specifications @ 25 °C – Operating Temperature – 40°C to +85 °C

Part Number	Insertion Loss (dB Max)	Return Loss (dB Min)			Crosstalk (dB Min)				DM to CM Rejection Ratio (dB Min)			Dielectric Withstanding Voltage @60s (Vrms MIN)
	0.1-100 MHz	30 MHz	60 MHz	80 MHz	1 MHz	30 MHz	60 MHz	100 MHz	30 MHz	60 MHz	100 MHz	
R2002NL	-1.2	-18	-14	-12	-50	-43	-37	-33	-43	-37	-33	1500

Notes: 1. Add suffix "T" to part number for Tape & Reel package (ie: **R2002NLT**).

Mechanical

R2002NL

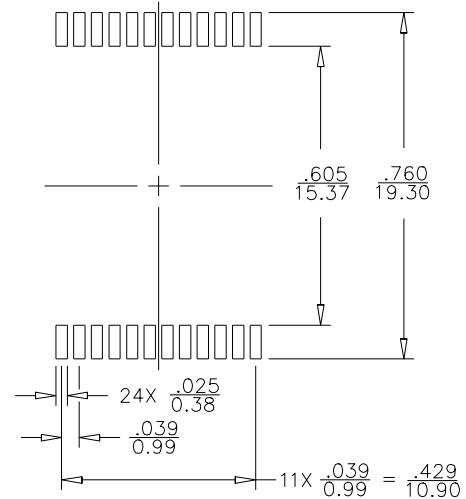
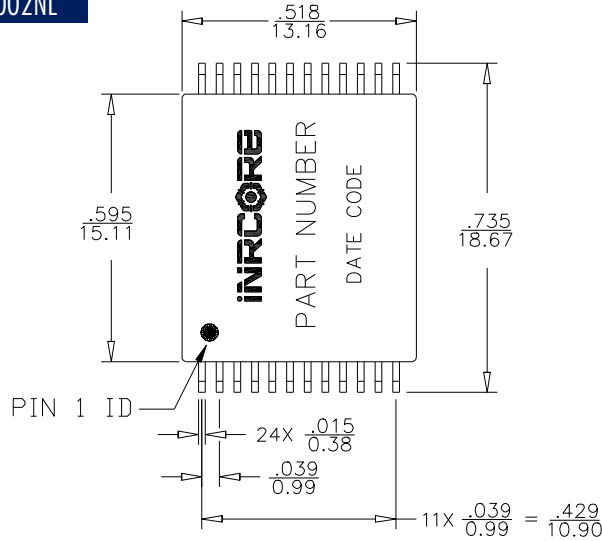

SUGGESTED LAND PATTERN

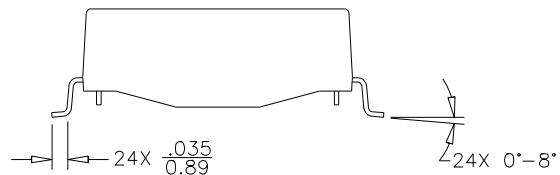
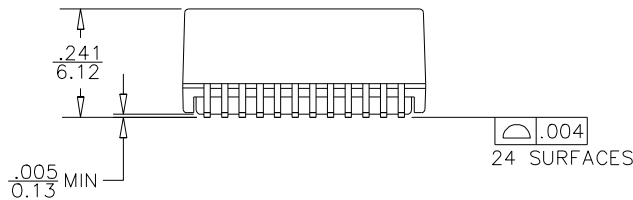

Dimensions: $\frac{\text{Inches}}{\text{mm}}$
 Unless otherwise specified,
 all tolerances are + .010

Weight.....3.0grams
 Tape and Reel.....300/reel
 Tube 25/tube



10/100BASE-T DUAL PORT TRANSFORMER MODULES

Industrial grade



Electrical Schematic

R2002NL

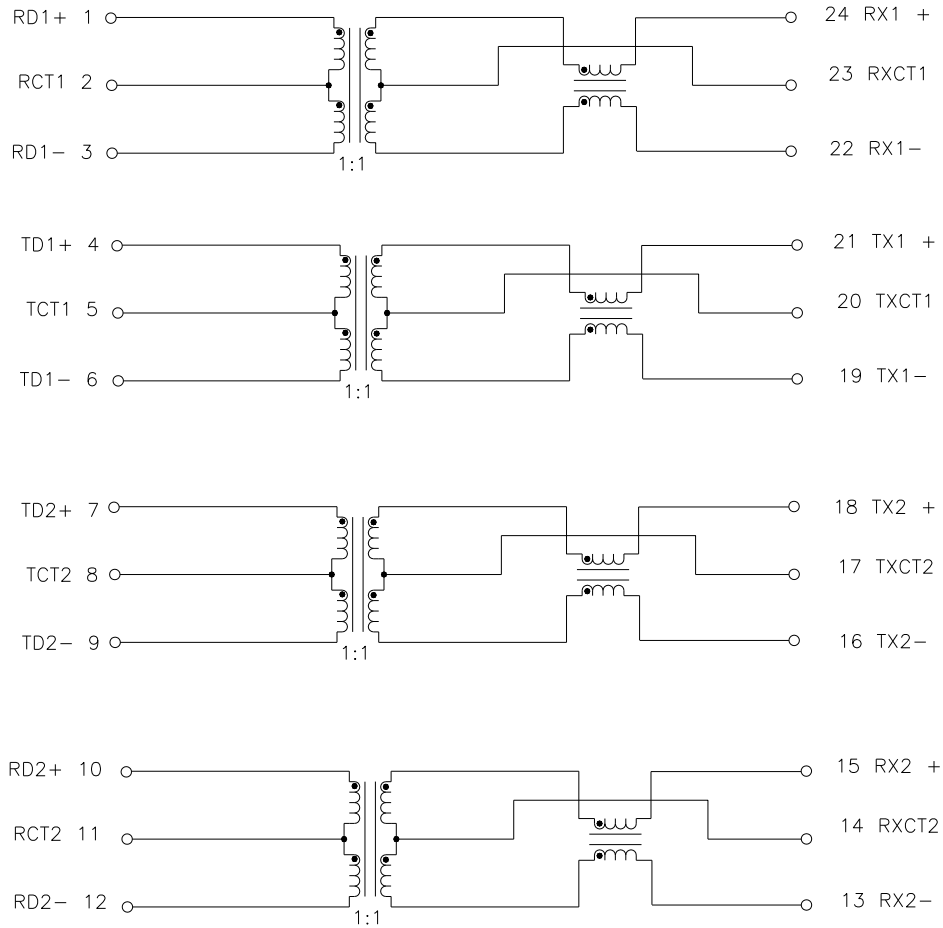

LEGEND

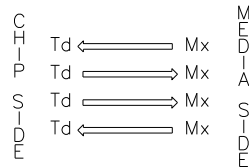

ALL CHANNELS ARE
IN-PHASE BETWEEN
INPUT AND OUTPUT



10/100BASE-T DUAL PORT TRANSFORMER MODULES

Industrial grade



Non-Lead Recommended Reflow Profile (Based on J-STD-020D)

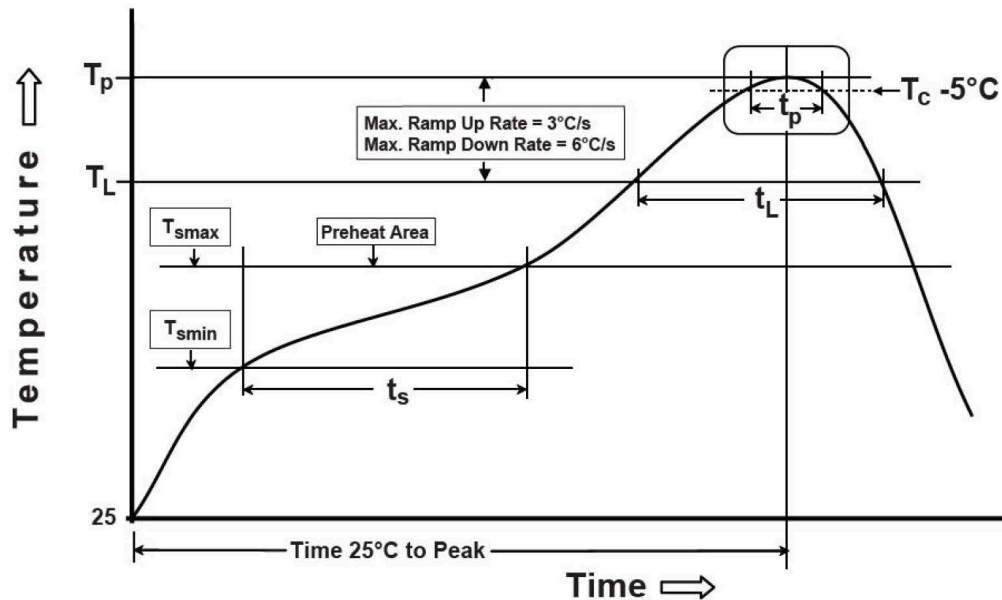

T_{SMIN} (°C)	T_{SMAX} (°C)	T_L (°C)	T_P (°C MAX)	t_s (s)	t_L (s)	t_p (s MAX)	Ramp-up rate (T_L to T_P)	Ramp-down rate (T_P to T_L)	Time 25°C to peak temperature (s MAX)
150	200	217	245	60-120	60-150	30	3°C/s MAX	6°C/s MAX	480

Notes:

1. All temperatures measured on the package leads.
2. Maximum times of reflow cycle: 2.

For More Information

iNRCORE,LLC
311 Sinclair Road Bristol,
PA 19007-6812 U.S.A
Tel: + 1.215.781.6400
Fax: +1.215.7816430

Dongguan iNRCORE Co. Ltd
No.7, An Li Road, Changan Town,
Dongguan City, China
Tel: +0769 8165 9962

Global Sales Representatives and Locations:
<http://www.inrcore.com>

Performance warranty of products offered on this data sheet is limited to the parameters specified. Data is subject to change without notice. Other brand and product names mentioned herein may be trademarks or registered trademarks of their respective owners. © Copyright, 2020. iNRCORE, LLC. All rights reserved.

