

IRF6619

DirectFET™ Power MOSFET ②

- Low Profile (<0.7 mm)
- Dual Sided Cooling Compatible ①
- Ultra Low Package Inductance
- Optimized for High Frequency Switching above 1MHz ①
- Ideal for CPU Core DC-DC Converters
- Optimized for Sync. FET socket of Sync. Buck Converter①
- Low Conduction Losses
- Compatible with existing Surface Mount Techniques ①

Typical values (unless otherwise specified)

V_{DS}	V_{GS}	$R_{DS(on)}$	$R_{DS(on)}$		
20V max	±20V max	1.65mΩ @ 10V	2.2mΩ @ 4.5V		
$Q_{g\ tot}$	Q_{gd}	Q_{gs2}	Q_{rr}	Q_{oss}	$V_{gs(th)}$
38nC	13nC	3.5nC	18nC	22nC	2.0V

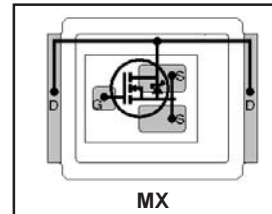

Applicable DirectFET Outline and Substrate Outline (see p.7,8 for details)①

SQ	SX	ST		MQ	MX	MT				
----	----	----	--	----	-----------	----	--	--	--	--

Description

The IRF6619 combines the latest HEXFET® Power MOSFET Silicon technology with the advanced DirectFET™ packaging to achieve the lowest on-state resistance in a package that has the footprint of an SO-8 and only 0.7 mm profile. The DirectFET package is compatible with existing layout geometries used in power applications, PCB assembly equipment and vapor phase, infra-red or convection soldering techniques, when application note AN-1035 is followed regarding the manufacturing methods and processes. The DirectFET package allows dual sided cooling to maximize thermal transfer in power systems, IMPROVING previous best thermal resistance by 80%.

The IRF6619 balances both low resistance and low charge along with ultra low package inductance to reduce both conduction and switching losses. The reduced total losses make this product ideal for high efficiency DC-DC converters that power the latest generation of processors operating at higher frequencies. The IRF6619 has been optimized for parameters that are critical in synchronous buck operating from 12 volt buss converters including Rds(on), gate charge and Cdv/dt-induced turn on immunity. The IRF6619 offers particularly low Rds(on) and high Cdv/dt immunity for synchronous FET applications.

Absolute Maximum Ratings

	Parameter	Max.	Units
V_{DS}	Drain-to-Source Voltage	20	V
V_{GS}	Gate-to-Source Voltage	±20	
$I_D @ T_A = 25^\circ C$	Continuous Drain Current, $V_{GS} @ 10V$ ⑥	30	A
$I_D @ T_A = 70^\circ C$	Continuous Drain Current, $V_{GS} @ 10V$ ⑥	24	
$I_D @ T_C = 25^\circ C$	Continuous Drain Current, $V_{GS} @ 10V$ ⑥ (Package Limited)	150	
I_{DM}	Pulsed Drain Current ③	240	
E_{AS} (Thermally limited)	Single Pulse Avalanche Energy ④	240	mJ
I_{AR}	Avalanche Current ③	See Fig. 14, 15, 17a, 17b,	A
E_{AR}	Repetitive Avalanche Energy ③		mJ

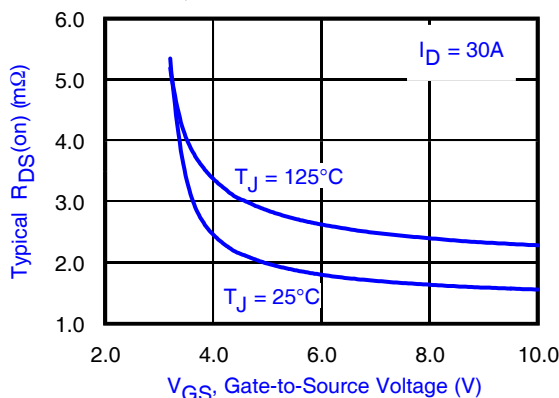

Fig 1. Typical On-Resistance Vs. Gate Voltage

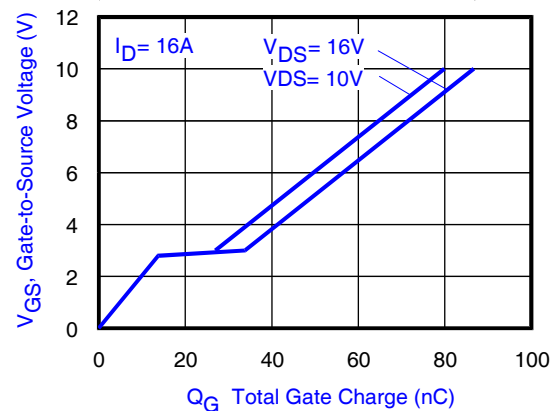

Fig 2. Typical Total Gate Charge vs Gate-to-Source Voltage

Notes:

- ① Click on this section to link to the appropriate technical paper.
- ② Click on this section to link to the DirectFET Website.
- ③ Repetitive rating; pulse width limited by max. junction temperature.

- ④ Limited by T_{Jmax} , starting $T_J = 25^\circ C$, $L = 0.86mH$, $R_G = 25\Omega$, $I_{AS} = 24A$, $V_{GS} = 10V$. Part not recommended for use above this value.
- ⑥ Surface mounted on 1 in. square Cu board, steady state.
- ⑦ T_C measured with thermocouple mounted to top (Drain) of part.

Static @ $T_J = 25^\circ\text{C}$ (unless otherwise specified)

	Parameter	Min.	Typ.	Max.	Units	Conditions
BV_{DSS}	Drain-to-Source Breakdown Voltage	20	—	—	V	$V_{GS} = 0V, I_D = 250\mu A$
$\Delta BV_{DSS}/\Delta T_J$	Breakdown Voltage Temp. Coefficient	—	14	—	mV/°C	Reference to $25^\circ\text{C}, I_D = 1\text{mA}$
$R_{DS(on)}$	Static Drain-to-Source On-Resistance	—	1.65	2.2	mΩ	$V_{GS} = 10V, I_D = 30A$ ③
		—	2.2	3.0		$V_{GS} = 4.5V, I_D = 24A$ ③
$V_{GS(th)}$	Gate Threshold Voltage	1.55	—	2.45	V	$V_{DS} = V_{GS}, I_D = 250\mu A$
$\Delta V_{GS(th)}/\Delta T_J$	Gate Threshold Voltage Coefficient	—	-5.8	—	mV/°C	
I_{DSS}	Drain-to-Source Leakage Current	—	—	1.0	μA	$V_{DS} = 16V, V_{GS} = 0V$
		—	—	150		$V_{DS} = 16V, V_{GS} = 0V, T_J = 125^\circ\text{C}$
I_{GSS}	Gate-to-Source Forward Leakage	—	—	100	nA	$V_{GS} = 20V$
	Gate-to-Source Reverse Leakage	—	—	-100		$V_{GS} = -20V$
g_{fs}	Forward Transconductance	89	—	—	S	$V_{DS} = 10V, I_D = 24A$
Q_g	Total Gate Charge	—	38	57	nC	$V_{DS} = 10V$ $V_{GS} = 4.5V$ $I_D = 16A$ See Fig. 17
Q_{gs1}	Pre-Vth Gate-to-Source Charge	—	10.2	—		
Q_{gs2}	Post-Vth Gate-to-Source Charge	—	3.5	—		
Q_{gd}	Gate-to-Drain Charge	—	13.2	—		
Q_{godr}	Gate Charge Overdrive	—	11.1	—		
Q_{sw}	Switch Charge ($Q_{gs2} + Q_{gd}$)	—	16.7	—		
Q_{oss}	Output Charge	—	22	—	nC	$V_{DS} = 10V, V_{GS} = 0V$
R_G	Gate Resistance	—	—	2.3	Ω	
$t_{d(on)}$	Turn-On Delay Time	—	21	—	ns	$V_{DD} = 16V, V_{GS} = 4.5V$ ③ $I_D = 24A$ Clamped Inductive Load
t_r	Rise Time	—	71	—		
$t_{d(off)}$	Turn-Off Delay Time	—	25	—		
t_f	Fall Time	—	9.3	—		
C_{iss}	Input Capacitance	—	5040	—	pF	$V_{GS} = 0V$ $V_{DS} = 10V$ $f = 1.0\text{MHz}$
C_{oss}	Output Capacitance	—	1580	—		
C_{rss}	Reverse Transfer Capacitance	—	780	—		

Diode Characteristics

	Parameter	Min.	Typ.	Max.	Units	Conditions
I_S	Continuous Source Current (Body Diode)	—	—	30	A	MOSFET symbol showing the integral reverse p-n junction diode.
I_{SM}	Pulsed Source Current (Body Diode) ③	—	—	240		
V_{SD}	Diode Forward Voltage	—	0.8	1.0	V	$T_J = 25^\circ\text{C}, I_S = 24A, V_{GS} = 0V$ ③
t_{rr}	Reverse Recovery Time	—	29	44	ns	$T_J = 25^\circ\text{C}, I_F = 24A$
Q_{rr}	Reverse Recovery Charge	—	18	27	nC	$di/dt = 100A/\mu s$ ③

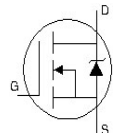

Notes:

- ③ Repetitive rating; pulse width limited by max. junction temperature.
- ⑤ Pulse width $\leq 400\mu s$; duty cycle $\leq 2\%$.

Absolute Maximum Ratings

	Parameter	Max.	Units
$P_D @ T_A = 25^\circ\text{C}$	Power Dissipation ⑥	2.8	W
$P_D @ T_A = 70^\circ\text{C}$	Power Dissipation ⑥	1.8	
$P_D @ T_C = 25^\circ\text{C}$	Power Dissipation ⑨	89	
T_P	Peak Soldering Temperature	270	$^\circ\text{C}$
T_J	Operating Junction and	-40 to + 150	
T_{STG}	Storage Temperature Range		

Thermal Resistance

	Parameter	Typ.	Max.	Units
$R_{\theta JA}$	Junction-to-Ambient ⑥⑩	—	45	$^\circ\text{C}/\text{W}$
$R_{\theta JA}$	Junction-to-Ambient ⑦⑩	12.5	—	
$R_{\theta JA}$	Junction-to-Ambient ⑧⑩	20	—	
$R_{\theta JC}$	Junction-to-Case ⑨⑩	—	1.4	
$R_{\theta J-PCB}$	Junction-to-PCB Mounted	1.0	—	
	Linear Derating Factor ⑥	0.017		$\text{W}/^\circ\text{C}$

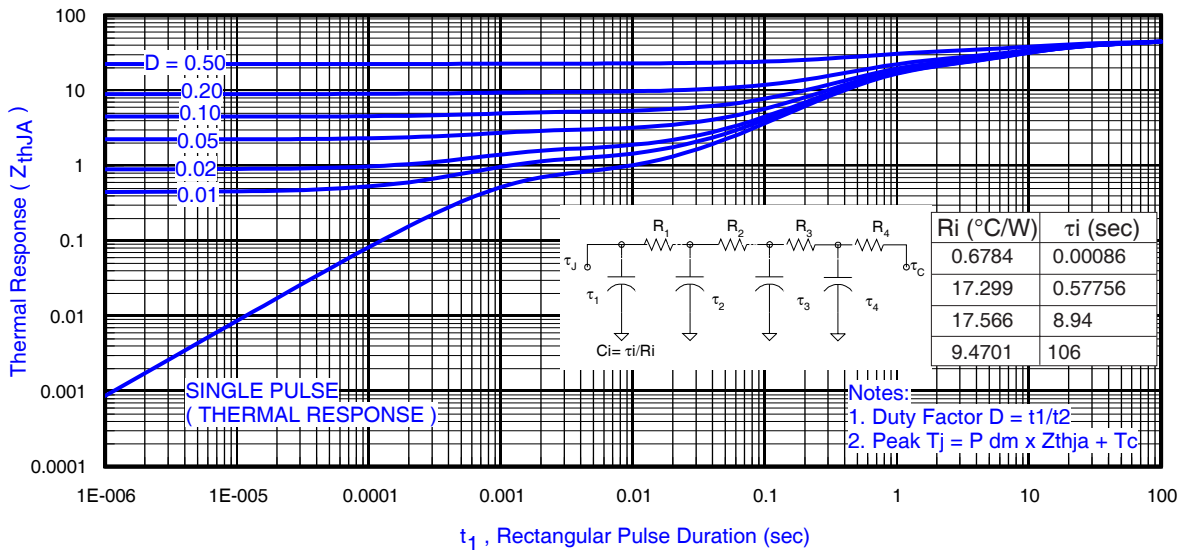
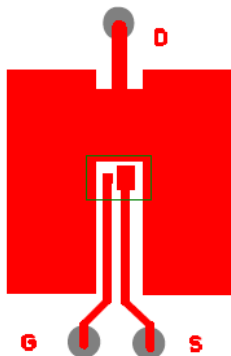

Fig 3. Maximum Effective Transient Thermal Impedance, Junction-to-Ambient ⑥

Notes:

- ⑥ Surface mounted on 1 in. square Cu board, steady state.
- ⑦ Used double sided cooling, mounting pad.
- ⑧ Mounted on minimum footprint full size board with metalized back and with small clip heatsink.

- ⑨ T_C measured with thermocouple incontact with top (Drain) of part.
- ⑩ R_{θ} is measured at T_J of approximately 90°C .



⑥ Surface mounted on 1 in. square Cu board (still air).

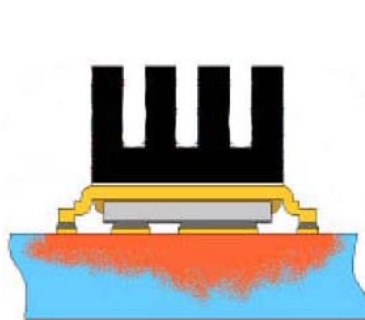

⑦ Mounted to a PCB with a thin gap filler and heat sink. (still air)

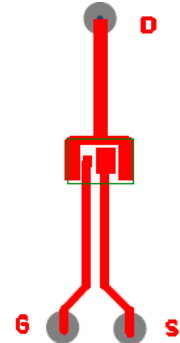

⑧ Mounted on minimum footprint full size board with metalized back and with small clip heatsink (still air)

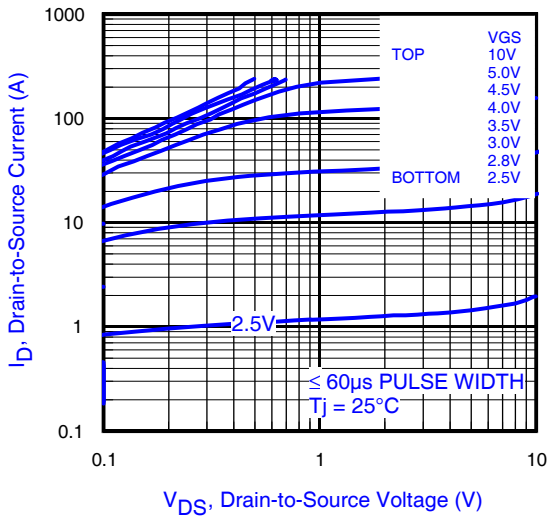

Fig 4. Typical Output Characteristics

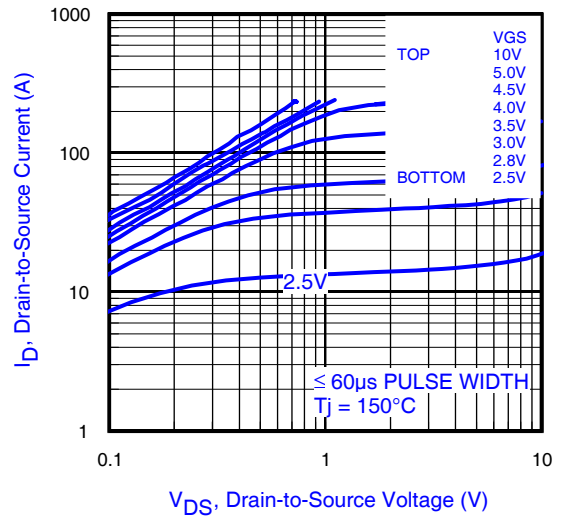

Fig 5. Typical Output Characteristics

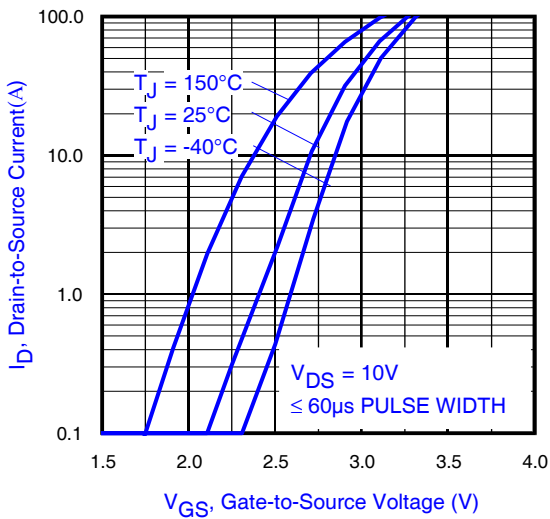

Fig 6. Typical Transfer Characteristics

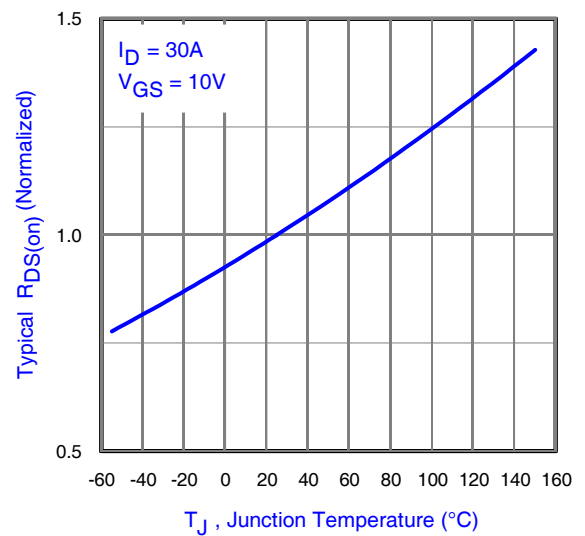

Fig 7. Normalized On-Resistance vs. Temperature

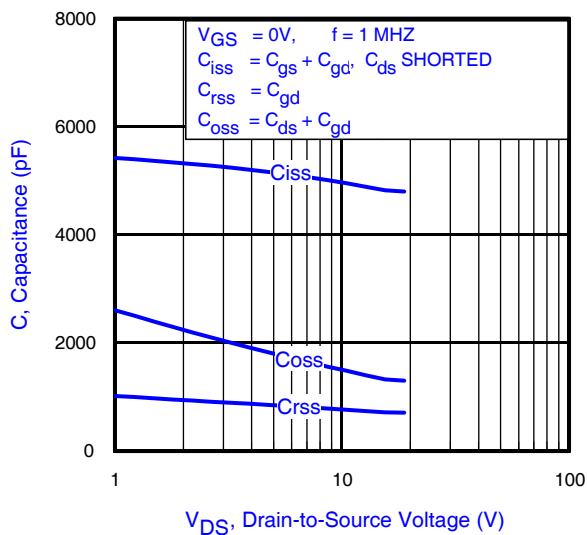

Fig 8. Typical Capacitance vs. Drain-to-Source Voltage

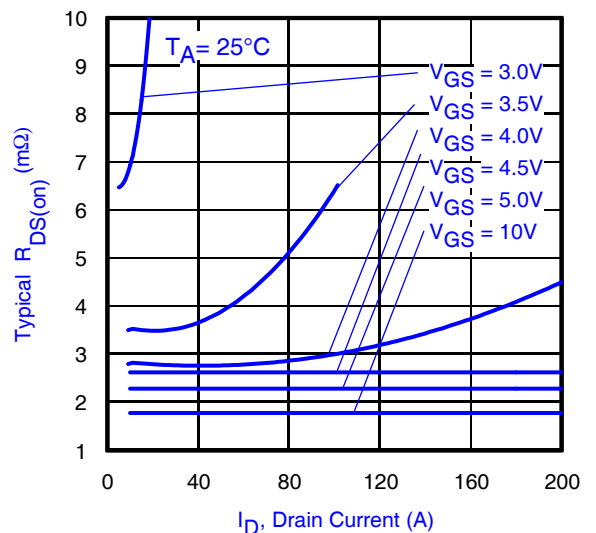

Fig 9. Typical On-Resistance Vs. Drain Current and Gate Voltage

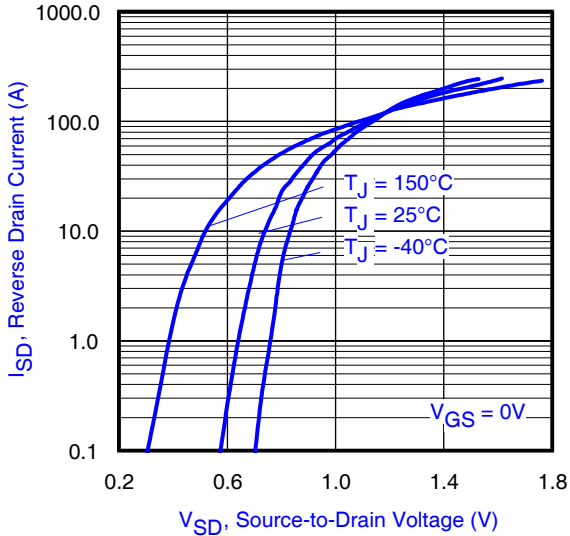

Fig 10. Typical Source-Drain Diode Forward Voltage

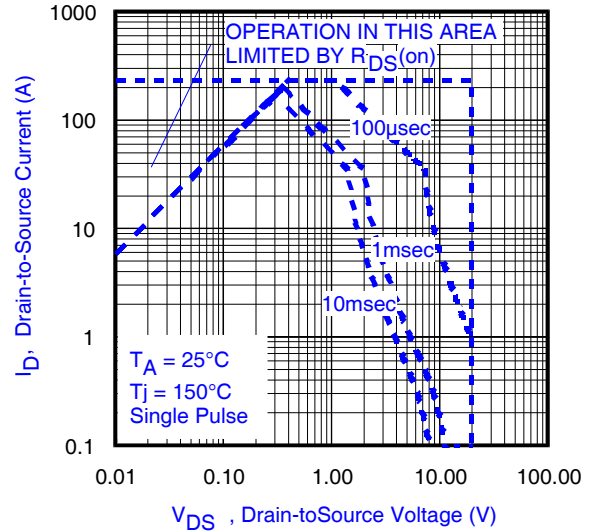

Fig 11. Maximum Safe Operating Area

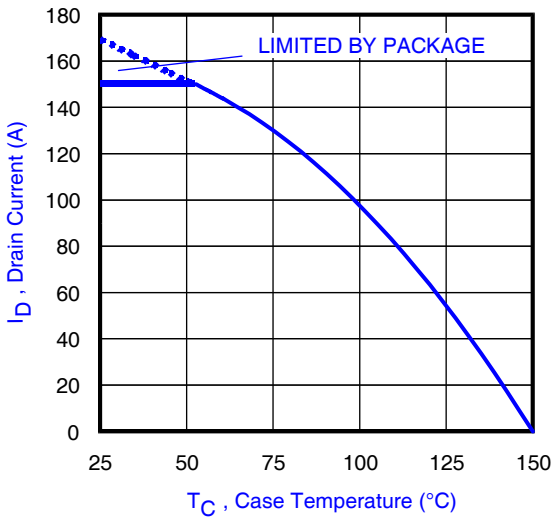

Fig 12. Maximum Drain Current vs. Case Temperature

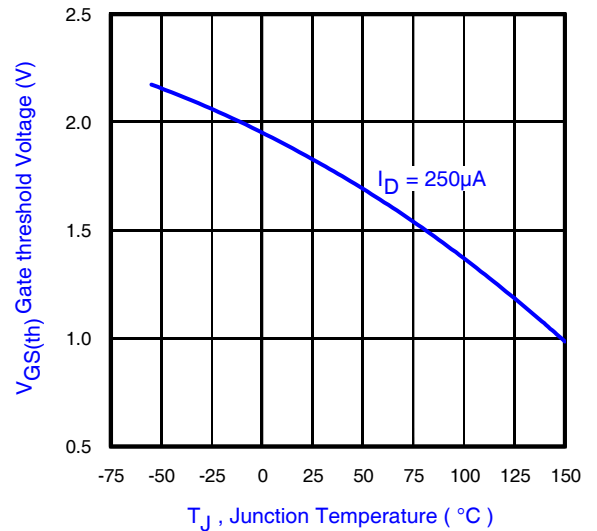

Fig 13. Typical Threshold Voltage vs. Junction Temperature

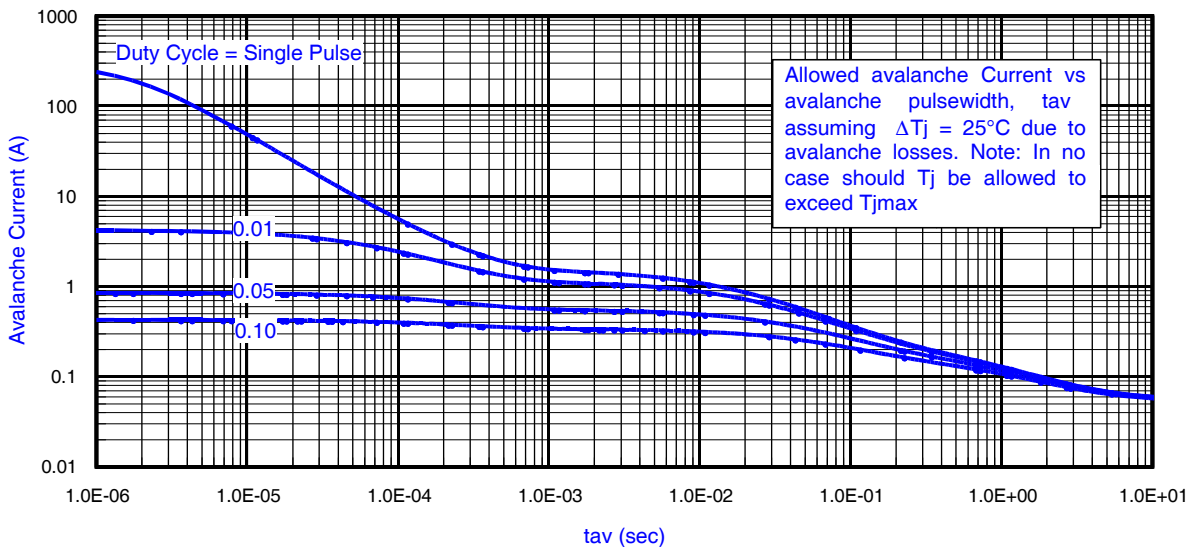

Fig 14. Typical Avalanche Current vs. Pulsewidth

IRF6619

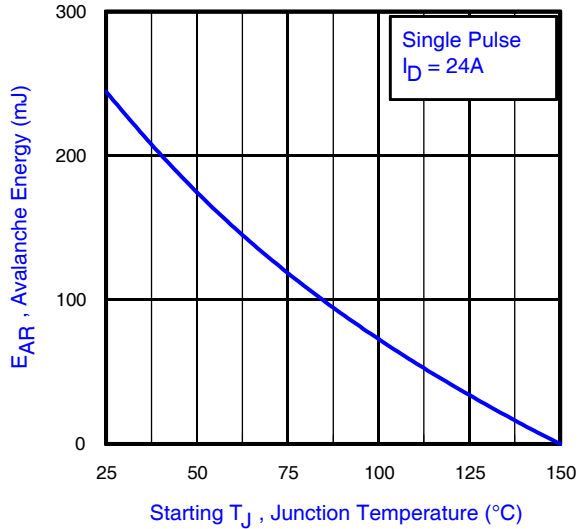

Fig 15. Maximum Avalanche Energy vs. Temperature

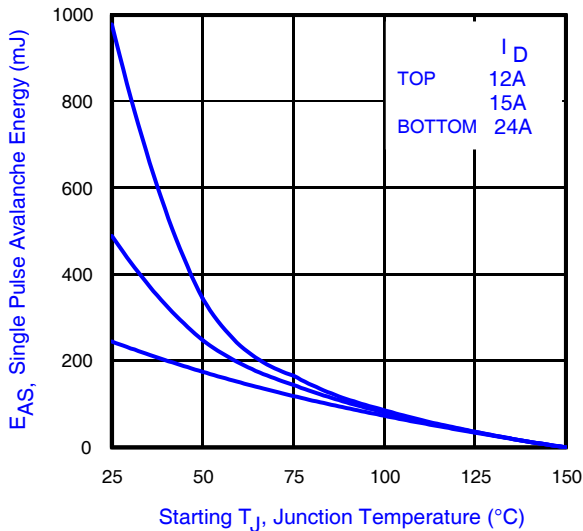

Fig 16. Maximum Avalanche Energy Vs. Drain Current

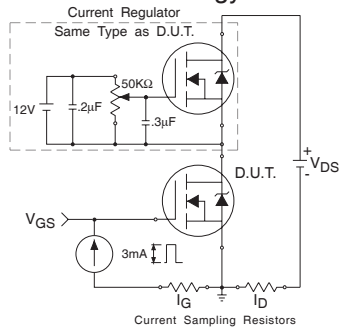

Fig 18a. Gate Charge Test Circuit

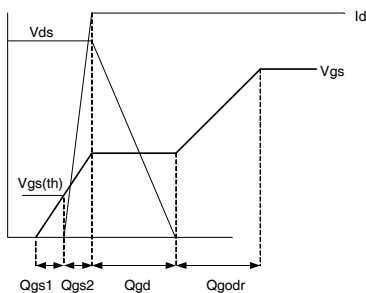

Fig 18b. Gate Charge Waveform

**Notes on Repetitive Avalanche Curves , Figures 14, 15:
(For further info, see AN-1005 at www.irf.com)**

1. Avalanche failures assumption:
Purely a thermal phenomenon and failure occurs at a temperature far in excess of T_{jmax} . This is validated for every part type.
2. Safe operation in Avalanche is allowed as long as T_{jmax} is not exceeded.
3. Equation below based on circuit and waveforms shown in Figures 17a, 17b.
4. $P_{D(ave)}$ = Average power dissipation per single avalanche pulse.
5. BV = Rated breakdown voltage (1.3 factor accounts for voltage increase during avalanche).
6. I_{av} = Allowable avalanche current.
7. ΔT = Allowable rise in junction temperature, not to exceed T_{jmax} (assumed as 25°C in Figure 14, 15).
 t_{av} = Average time in avalanche.
 D = Duty cycle in avalanche = $t_{av} \cdot f$
 $Z_{thJC}(D, t_{av})$ = Transient thermal resistance, see Figures 3)

$$P_{D(ave)} = 1/2 (1.3 \cdot BV \cdot I_{av}) = \Delta T / Z_{thJC}$$

$$I_{av} = 2\Delta T / [1.3 \cdot BV \cdot Z_{th}]$$

$$E_{AS(AR)} = P_{D(ave)} \cdot t_{av}$$

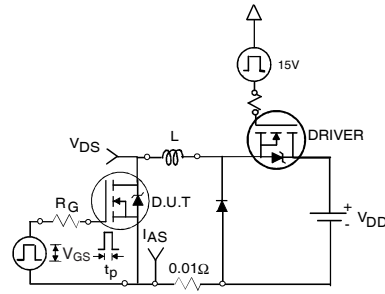

Fig 17a. Unclamped Inductive Test Circuit

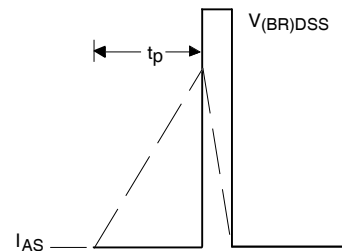

Fig 17b. Unclamped Inductive Waveforms

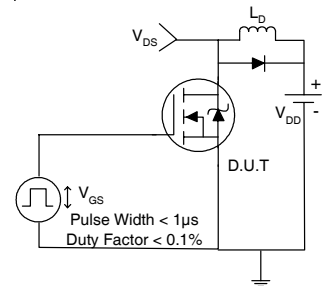

Fig 19a. Switching Time Test Circuit

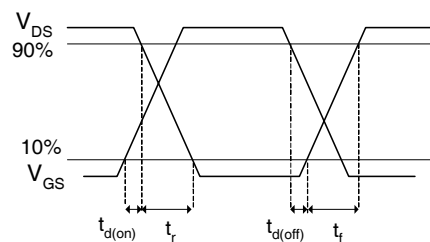

Fig 19b. Switching Time Waveforms

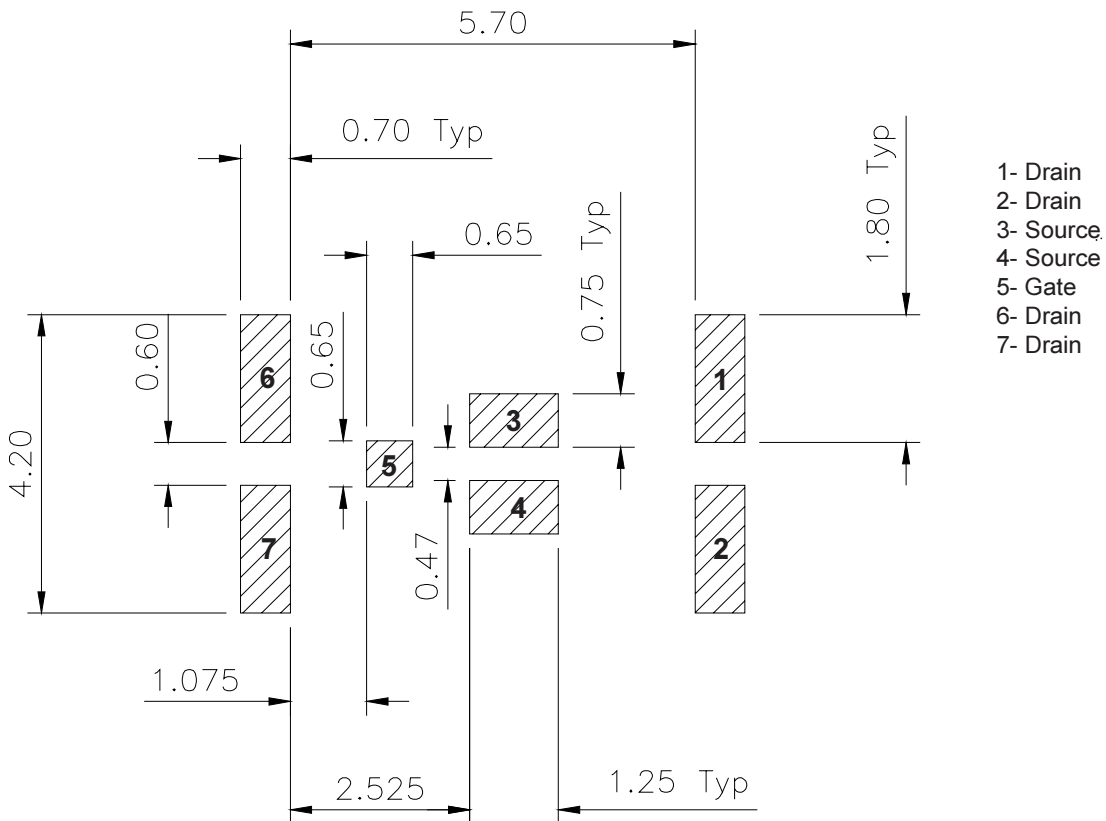

Fig 20. Diode Reverse Recovery Test Circuit for N-Channel HEXFET® Power MOSFETs

DirectFET™ Substrate and PCB Layout, MX Outline (Medium Size Can, X-Designation).

Please see DirectFET application note AN-1035 for all details regarding the assembly of DirectFET.

This includes all recommendations for stencil and substrate designs.



IRF6619

DirectFET™ Outline Dimension, MX Outline (Medium Size Can, X-Designation).

Please see DirectFET application note AN-1035 for all details regarding the assembly of DirectFET.

This includes all recommendations for stencil and substrate designs.

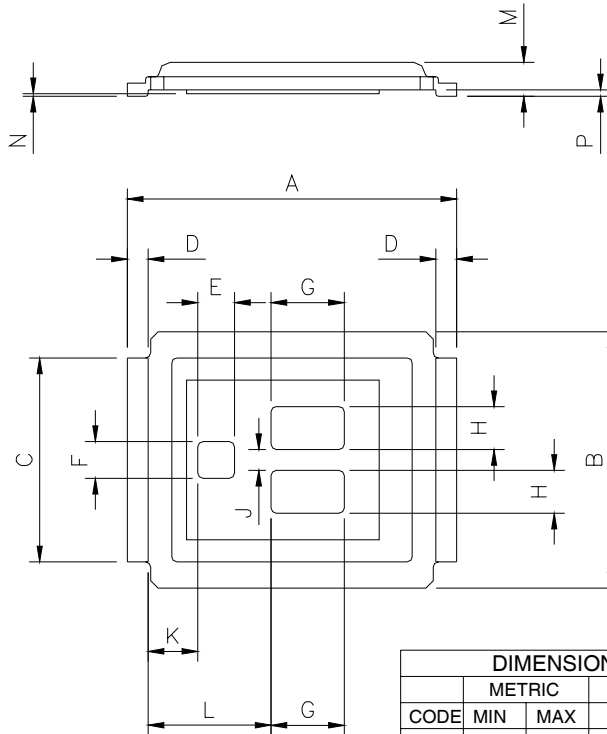

CODE	METRIC		IMPERIAL	
	MIN	MAX	MAX	MAX
A	6.25	6.35	0.246	0.250
B	4.80	5.05	0.189	0.201
C	3.85	3.95	0.152	0.156
D	0.35	0.45	0.014	0.018
E	0.68	0.72	0.027	0.028
F	0.68	0.72	0.027	0.028
G	1.38	1.42	0.054	0.056
H	0.80	0.84	0.032	0.033
J	0.38	0.42	0.015	0.017
K	0.88	1.01	0.035	0.039
L	2.28	2.41	0.090	0.095
M	0.59	0.70	0.023	0.028
N	0.03	0.08	0.001	0.003
P	0.08	0.17	0.003	0.007

DirectFET™ Part Marking

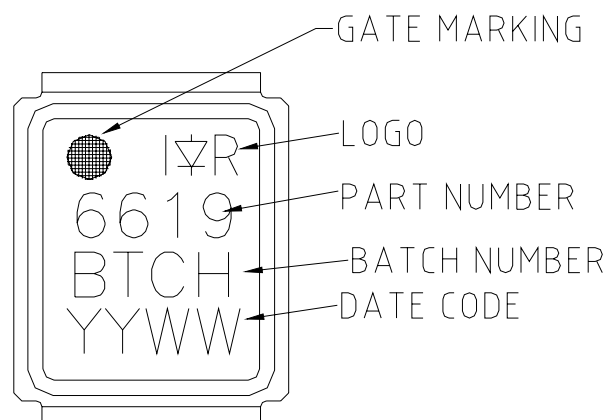

DirectFET™ Tape & Reel Dimension (Showing component orientation).

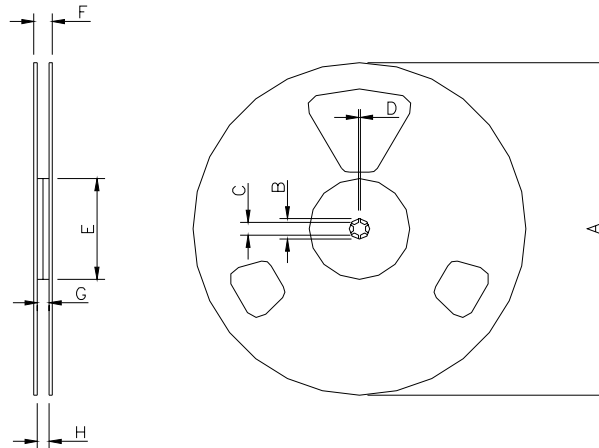

NOTE: Controlling dimensions in mm
 Std reel quantity is 4800 parts. (ordered as IRF6619). For 1000 parts on 7" reel,
 order IRF6619TR1

REEL DIMENSIONS									
STANDARD OPTION (QTY 4800)				TR1 OPTION (QTY 1000)					
		METRIC		IMPERIAL		METRIC		IMPERIAL	
		MIN	MAX	MIN	MAX	MIN	MAX	MIN	MAX
		12.992	N.C	177.77	N.C	6.9	N.C		
		0.795	N.C	19.06	N.C	0.75	N.C		
		0.504	0.520	13.5	12.8	0.53	0.50		
		0.059	N.C	1.5	N.C	0.059	N.C		
		3.937	N.C	58.72	N.C	2.31	N.C		
		N.C	0.724	N.C	13.50	N.C	0.53		
		0.488	0.567	11.9	12.01	0.47	N.C		
		0.469	0.606	11.9	12.01	0.47	N.C		

LOADED TAPE FEED DIRECTION

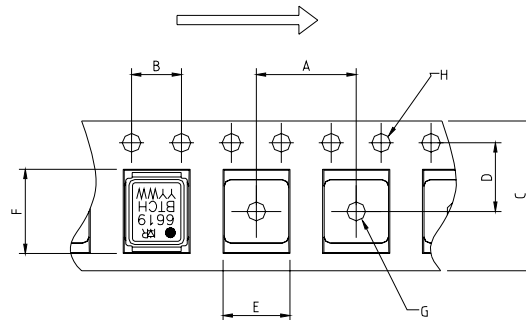

NOTE: CONTROLLING
 DIMENSIONS IN MM

CODE	DIMENSIONS			
	METRIC		IMPERIAL	
	MIN	MAX	MIN	MAX
A	7.90	8.10	0.311	0.319
B	3.90	4.10	0.154	0.161
C	11.90	12.30	0.469	0.484
D	5.45	5.55	0.215	0.219
E	5.10	5.30	0.201	0.209
F	6.50	6.70	0.256	0.264
G	1.50	N.C	0.059	N.C
H	1.50	1.60	0.059	0.063

Data and specifications subject to change without notice.
 This product has been designed and qualified for the Consumer market.
 Qualification Standards can be found on IR's Web site.