

Photologic® Slotted Optical Switch “Right Angle Package” Series



OPB920DZ

Features:

- Non-contact switching
- Right Angle Sensor: LED in tower, photosensor in base
- Choice of output configuration
- Optical line can be broken in three axis
- 24” minimum, 26 AWG UL approved wire leads

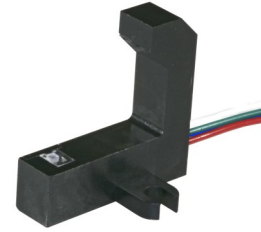

Description:

The **OPB920** series optical switch consists of an infrared emitting diode (LED) and a photologic sensor . The LED is mounted on the tower with the photologic sensor mounted on the base of a right angle shape package . The L-Shape or right angle package configuration allows for an opaque object to block the light beam from a multitude of directions including the X-axis Y-axis and Z-axis. The optical center line between the emitter and photosensor is at 45° from the mounting base of the device.

The OPB920 Series provides optimum flexibility for the design engineer. The engineer can specify the type of TTL output. For example the output can be: TTL totem pole, TTL open collector, either of which can be buffered or inverted output.

All versions have the added stability of hysteresis built into the circuitry.

Custom electrical, wire and cabling and connectors are available. Contact your local representative or OPTEK for more information.

Applications:

- Non-contact interruptive object sensing
- Tray-out sensor
- Amusement gaming equipment
- Low paper tray sensor
- Paper sorting equipment
- Corner sensor
- Printers
- Copying machines
- Door sensor
- Optical Switch

Part Number Guide — OPB920xZ Series	
	OPB920 _ Z
A = Totem Pole	
B = Open Collector	
C = Inverted Totem Pole	
D = Inverted Open Collector	
All versions with 26 AWG wire termination (24” [61cm] long)	

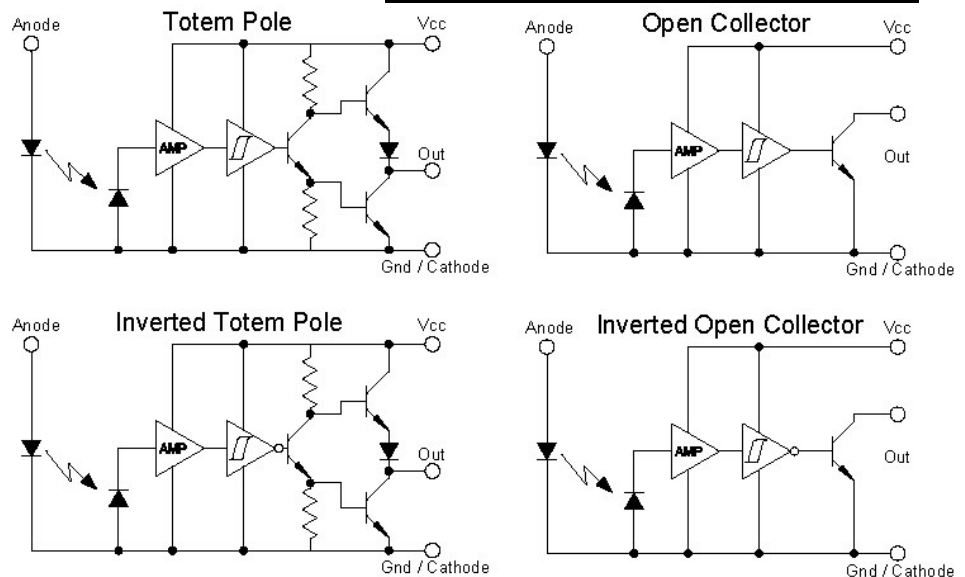

General Note
 TT Electronics reserves the right to make changes in product specification without notice or liability. All information is subject to TT Electronics’ own data and is considered accurate at time of going to print.

TT Electronics | OPTEK Technology
 2900 E. Plano Pkwy, Plano, TX 75074 | Ph: +1 972 323 2200
 www.ttelectronics.com | sensors@ttelectronics.com

Photologic® Slotted Optical Switch “Right Angle Package” Series



OPB920DZ

Pin name	Wire Color
Anode	Red
Cathode/Ground	Green
Vout	Blue
Vcc	White

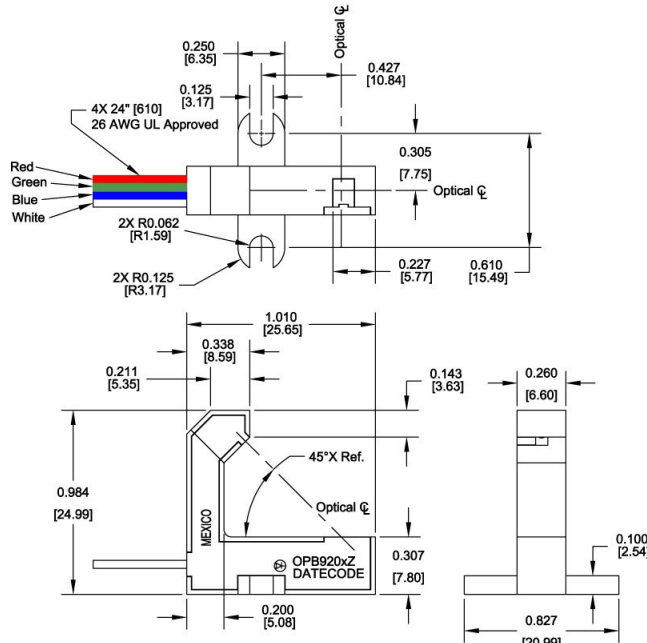

Note: Dimensions are in inches [mm]
Tolerances +/- 0.010" [0.25mm]

Absolute Maximum Ratings ($T_A = 25^\circ\text{C}$ unless otherwise noted)

Storage Temperature	-40° C to +85° C
Operating Temperature	-40° C to +70° C
Lead Soldering Temperature (1/16" (1.6 mm) from case for 5 seconds with soldering iron) ⁽¹⁾	260° C
Input Infrared LED	
DC Forward Diode (LED) Current	40 mA
DC Reverse Diode (LED) Voltage	2 V
Input Diode Power Dissipation ⁽¹⁾	100 mW
Output Photologic®	
Supply Voltage, V_{CC} (not to exceed 3 seconds)	18V
Voltage at Output Lead (Open Collector Output version)	35 V
Output Photologic® Power Dissipation ⁽²⁾	200 mW
Total Device Power Dissipation ⁽³⁾	300 mW

Notes:

- (1) Derate linearly 2.22 mW/°C above 25°C
- (2) Derate linearly 4.44 mW/°C above 25°C
- (3) Derate linearly 6.66 mW/°C above 25°C
- (4) RMA flux is recommended. Duration can be extended to 10 seconds maximum when flow soldering.
- (5) Methanol or isopropanol are recommended as cleaning agents. The plastic housing is soluble in chlorinated hydrocarbons and keytones.

General Note

TT Electronics reserves the right to make changes in product specification without notice or liability. All information is subject to TT Electronics' own data and is considered accurate at time of going to print.

TT Electronics | OPTEK Technology
2900 E. Plano Pkwy, Plano, TX 75074 | Ph: +1 972 323 2200
www.ttelectronics.com | sensors@ttelectronics.com

Photologic® Slotted Optical Switch “Right Angle Package” Series



OPB920DZ

Electrical Specifications

Electrical Characteristics ($T_A = 25^\circ\text{C}$ unless otherwise noted)

SYMBOL	PARAMETER	MIN	TYP	MAX	UNITS	TEST CONDITIONS
Input Diode (See OP240 for more information — for reference only)						
V_F	Forward Voltage	-	-	1.7	V	$I_F = 20\text{ mA}$, $T_A = 25^\circ\text{C}$
I_R	Reverse Current	-	-	100	μA	$V_R = 2\text{ V}$, $T_A = 25^\circ\text{C}$
Output Photologic® Sensor (See OPL560 for more information — for reference only)						
V_{CC}	Operating D.C. Supply Voltage	4.5	-	16	V	
I_{CCL}	Low Level Supply Current: Buffered Totem-Pole Output Buffered Open-Collector Output	-	-	15	mA	$V_{CC} = 16.0\text{ V}$, $I_F = 0\text{ mA}^{(1)}$
	Inverted Totem-Pole Output Inverted Open-Collector Output	-	-	15	mA	$V_{CC} = 16.0\text{ V}$, $I_F = 20\text{ mA}$
I_{CCH}	High Level Supply Current: Buffered Totem-Pole Output Buffered Open-Collector Output	-	-	15	mA	$V_{CC} = 16.0\text{ V}$, $I_F = 20\text{ mA}$
	Inverted Totem-Pole Output Inverted Open-Collector Output	-	-	15	mA	$V_{CC} = 16.0\text{ V}$, $I_F = 0\text{ mA}^{(1)}$
V_{OL}	Low Level Supply Current: Buffered Totem-Pole Output Buffered Open-Collector Output	-	-	0.4	V	$V_{CC} = 4.5\text{ V}$, $I_{OL} = 16\text{ mA}$, $I_F = 0\text{ mA}^{(1)}$
	Inverted Totem-Pole Output Inverted Open-Collector Output	-	-	0.4	V	$V_{CC} = 4.5\text{ V}$, $I_{OL} = 16\text{ mA}$, $I_F = 20\text{ mA}$
V_{OH}	High Level Output Voltage: Buffered Totem-Pole Output	2.4	-	-	V	$V_{CC} = 4.5\text{ V}$, $I_{OH} = -800\text{ }\mu\text{A}$, $I_F = 20\text{ mA}$
	Inverted Totem-Pole Output	2.4	-	-	V	$V_{CC} = 4.5\text{ V}$, $I_{OH} = -800\text{ }\mu\text{A}$, $I_F = 0\text{ mA}^{(1)}$
I_{OH}	High Level Output Current: Buffered Open-Collector Output	-	-	100	μA	$V_{CC} = 4.5\text{ V}$, $V_{OH} = 30\text{ V}$, $T_A = 25^\circ\text{C}$
	Inverted Open-Collector Output	-	-	100	μA	$V_{CC} = 4.5\text{ V}$, $V_{OH} = 30\text{ V}$, $T_A = 25^\circ\text{C}$
$I_F(+)$	LED Positive-Going Threshold Current	-	-	20	mA	$V_{CC} = 5\text{ V}$, $T_A = 25^\circ\text{C}$
$I_F(+)/I_F(-)$	Hysteresis	-	2	-	-	$V_{CC} = 5\text{ V}$
t_r, t_f	Output Rise Time, Output Fall Time ⁽²⁾	-	70	-	ns	$V_{CC} = 5\text{ V}$, $T_A = 25^\circ\text{C}$ $I_F = 0$ or 20 mA
t_{PLH}, t_{PHL}	Propagation Delay Low-High and High-Low ⁽²⁾	-	5	-	μs	$R_L = 8\text{ TTL Loads (Totem-Pole)}$ $R_L = 360\text{ }\Omega$ (Open-Collector)

Notes:

- (1) Normal application would be with light source blocked, simulated by $I_F = 0\text{ mA}$.
- (2) By design not tested.

General Note

TT Electronics reserves the right to make changes in product specification without notice or liability. All information is subject to TT Electronics' own data and is considered accurate at time of going to print.

TT Electronics | OPTEK Technology
2900 E. Plano Pkwy, Plano, TX 75074 | Ph: +1 972 323 2200
www.ttelectronics.com | sensors@ttelectronics.com

Photologic® Slotted Optical Switch “Right Angle Package” Series



OPB920DZ

Typical Output Voltage Vs Blocking Distance (Z-Axis Blocked)

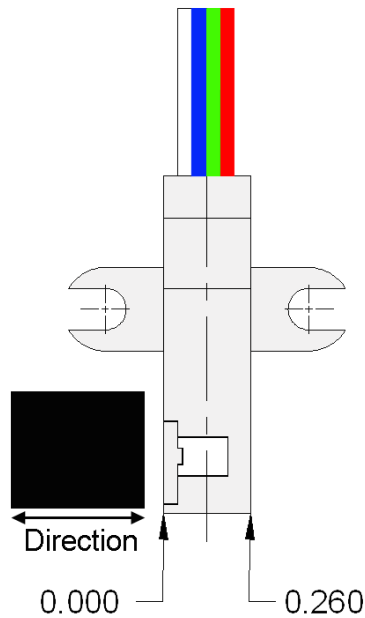
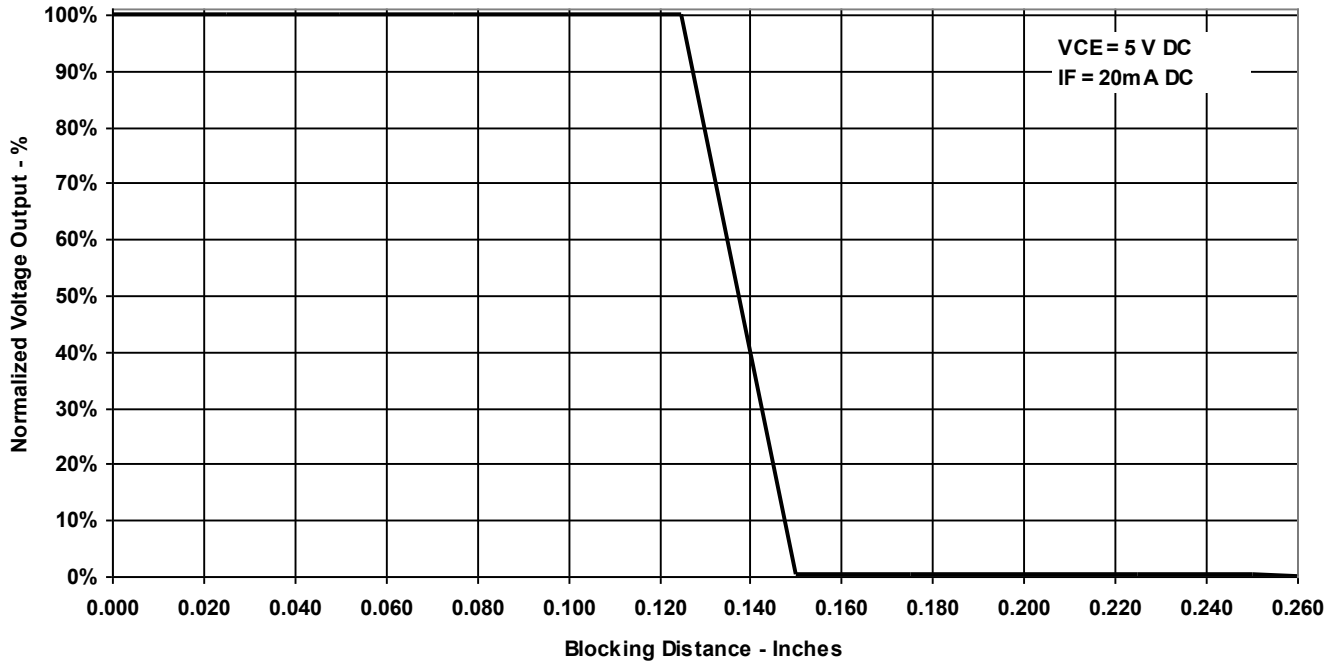

General Note
TT Electronics reserves the right to make changes in product specification without notice or liability. All information is subject to TT Electronics' own data and is considered accurate at time of going to print.

TT Electronics | OPTEK Technology
2900 E. Plano Pkwy, Plano, TX 75074 | Ph: +1 972 323 2200
www.ttelectronics.com | sensors@ttelectronics.com

Photologic® Slotted Optical Switch “Right Angle Package” Series



OPB920DZ

Typical Voltage Output Vs Blocking Distance
(Y-Axis Blocked)

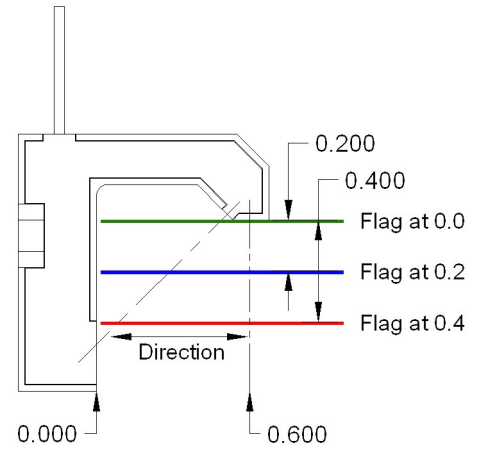
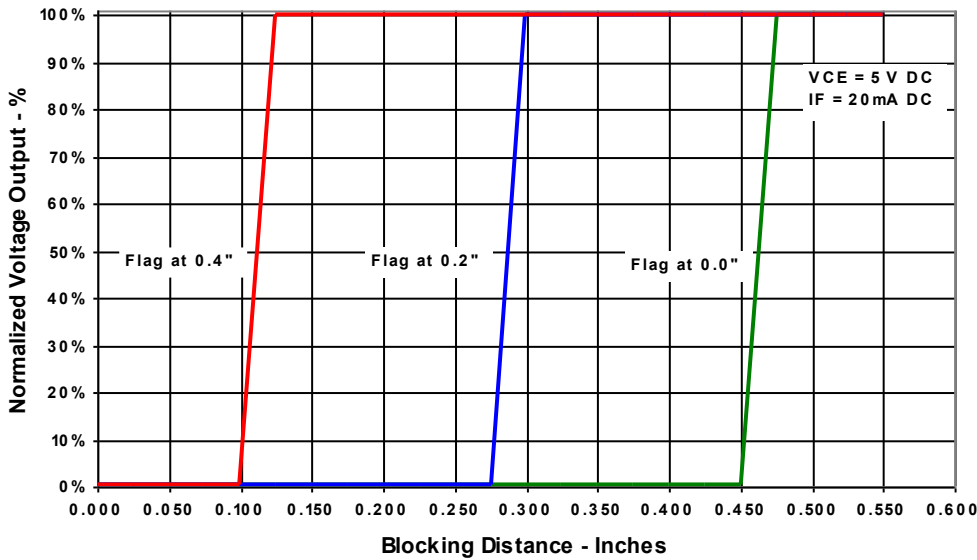

Typical Voltage Output Vs Blocking Distance
(X-Axis Blocked)

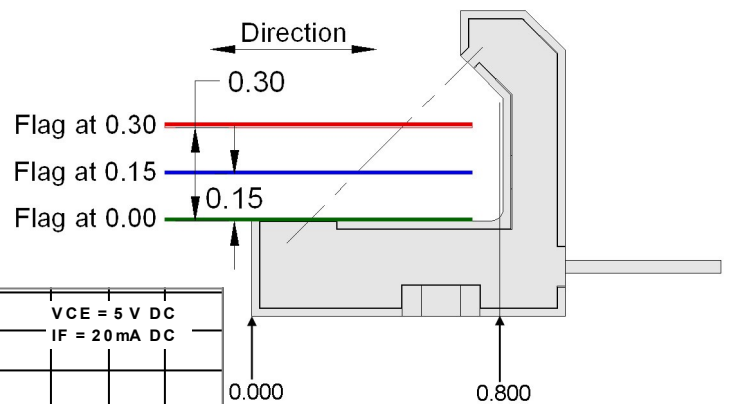
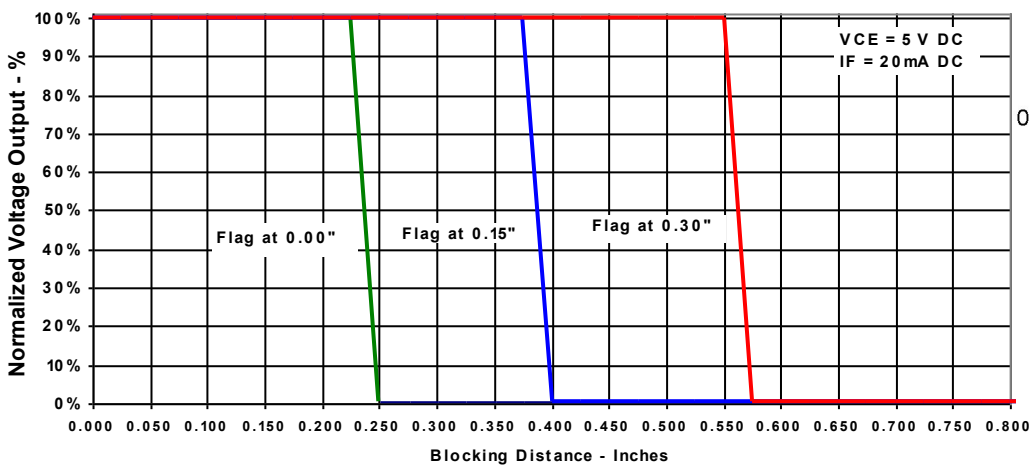

General Note
TT Electronics reserves the right to make changes in product specification without notice or liability. All information is subject to TT Electronics' own data and is considered accurate at time of going to print.

TT Electronics | OPTEK Technology
2900 E. Plano Pkwy, Plano, TX 75074 | Ph: +1 972 323 2200
www.ttelectronics.com | sensors@ttelectronics.com

Photologic® Slotted Optical Switch “Right Angle Package” Series



OPB920DZ

Typical Output Voltage Vs Ambient Temperature

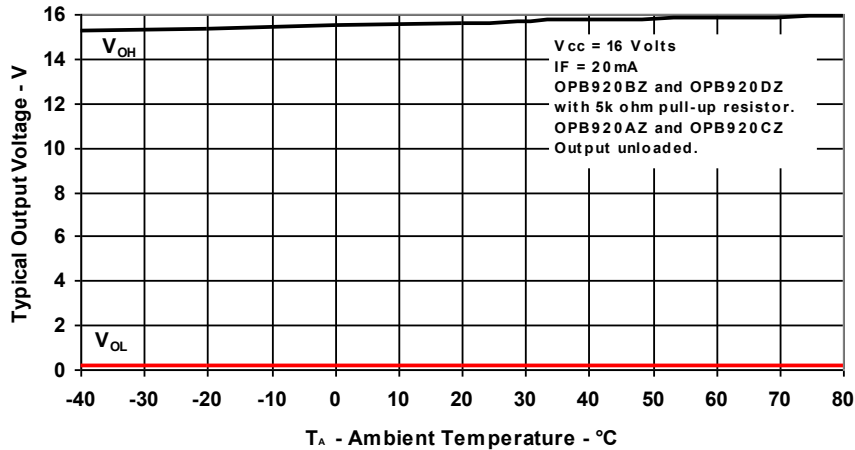

Normalized Supply Current Vs Ambient Temperature

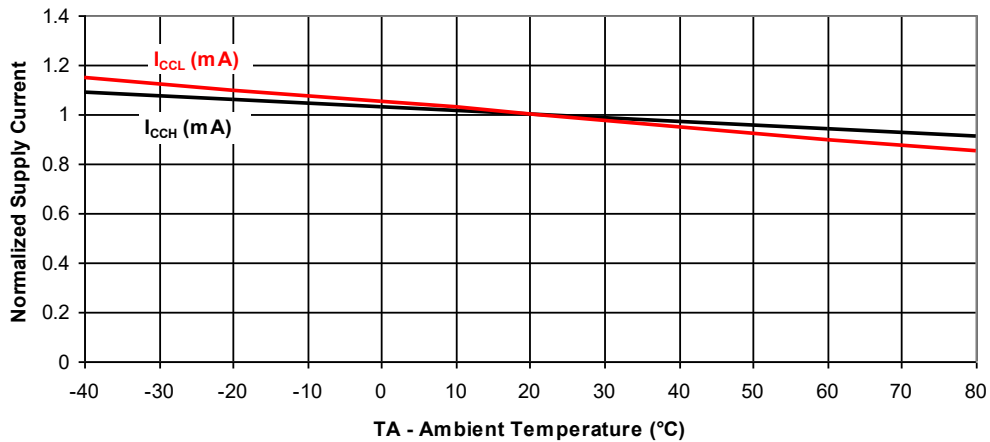

Normalized Positive Going Trigger Current and Hysteresis Vs Ambient Temperature

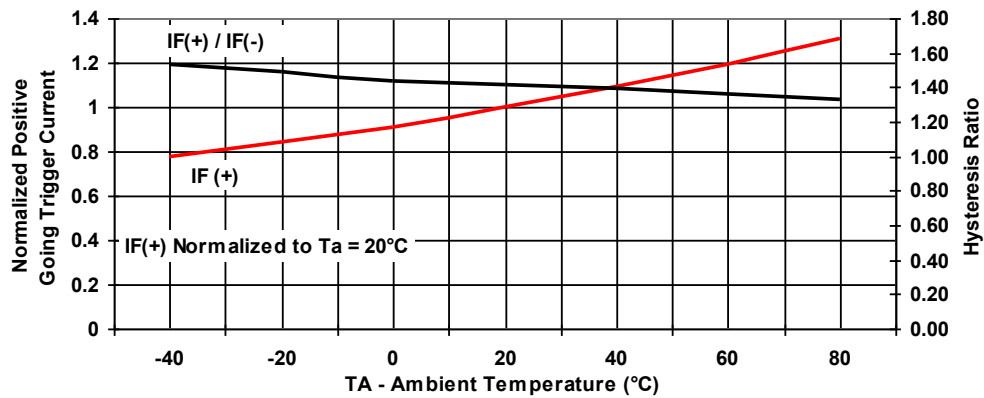

General Note
 TT Electronics reserves the right to make changes in product specification without notice or liability. All information is subject to TT Electronics' own data and is considered accurate at time of going to print.

TT Electronics | OPTEK Technology
 2900 E. Plano Pkwy, Plano, TX 75074 | Ph: +1 972 323 2200
www.ttelectronics.com | sensors@ttelectronics.com