

**NOT RECOMMENDED FOR NEW DESIGNS
NO RECOMMENDED REPLACEMENT**
contact our Technical Support Center at
1-888-INTERSIL or www.intersil.com/tsc

January 31, 2005

FN7376.2

6-Channel Clock Driver

The EL5001 is a 6-channel level shifting driver designed primarily for use as a clock driver in LTPS LCD displays. The EL5001 buffers and level shifts six logic level input signals. The six channels are grouped in to two sets, one of two channels and one of four channels. Each set can be configured in the inverting or non-inverting modes. Operating from 3.3V input logic, the output swing is set using two reference input pins. These pins can be up to 18V differential and are not buffered, so should therefore be bypassed effectively.

The EL5001 is designed to drive capacitive loads of 500pF with rise and fall times of just 20ns. A three-state pin is provided to set all outputs in to a high impedance mode. The ENABLE pin can be used to put the device in to a power save mode where the power consumption drops to just 3µA.

The EL5001 is available in 20-pin QFN (4mm x 4mm) and HTSSOP packages. Both are specified for operation over the -40°C to +85°C temperature range.

Features

- Six inverting/non-inverting channels
- 3.3V input logic
- 18V output
- 250µA typical supply current
- Drives up to 500pF
- $T_R/T_F = 35ns$ max
- Disable function
- 20-pin QFN (4mm x 4mm) and HTSSOP packages
- Pb-free available (RoHS compliant)

Applications

- LTPS LCD clock drivers
- CCD driving
- Level shifters

Ordering Information

PART NUMBER	PACKAGE	TAPE & REEL	PKG. DWG. #
EL5001IL	20-Pin QFN (4mm x 4mm)	-	MDP0046
EL5001IL-T7	20-Pin QFN (4mm x 4mm)	7"	MDP0046
EL5001IL-T13	20-Pin QFN (4mm x 4mm)	13"	MDP0046
EL5001ILZ (See Note)	20-Pin QFN (4mm x 4mm) (Pb-Free)	-	MDP0046
EL5001ILZ-T7 (See Note)	20-Pin QFN (4mm x 4mm) (Pb-Free)	7"	MDP0046
EL5001ILZ-T13 (See Note)	20-Pin QFN (4mm x 4mm) (Pb-Free)	13"	MDP0046

PART NUMBER	PACKAGE	TAPE & REEL	PKG. DWG. #
EL5001IRE	20-Pin HTSSOP	-	MDP0048
EL5001IRE-T7	20-Pin HTSSOP	7"	MDP0048
EL5001IRE-T13	20-Pin HTSSOP	13"	MDP0048
EL5001IREZ (See Note)	20-Pin HTSSOP (Pb-Free)	-	MDP0048
EL5001IREZ-T7 (See Note)	20-Pin HTSSOP (Pb-Free)	7"	MDP0048
EL5001IREZ-T13 (See Note)	20-Pin HTSSOP (Pb-Free)	13"	MDP0048

NOTE: Intersil Pb-free products employ special Pb-free material sets; molding compounds/die attach materials and 100% matte tin plate termination finish, which are RoHS compliant and compatible with both SnPb and Pb-free soldering operations. Intersil Pb-free products are MSL classified at Pb-free peak reflow temperatures that meet or exceed the Pb-free requirements of IPC/JEDEC J STD-020C.

Pinouts

EL5001
[20-PIN QFN (4MM X 4MM)]
TOP VIEW

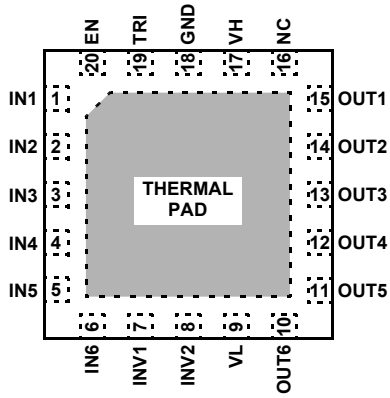

EL5001
(20-PIN HSSOP)
TOP VIEW

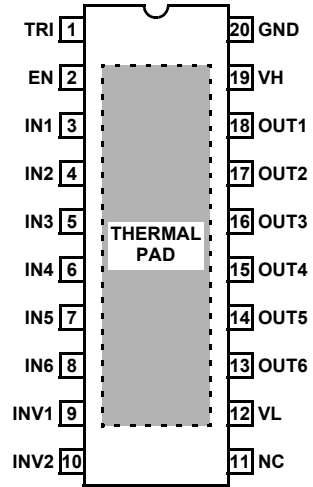

Absolute Maximum Ratings ($T_A = 25^\circ\text{C}$)

Supply Voltage between V_{SD} and GND18V	Maximum Die Temperature +125°C
Maximum Continuous Output Current 50mA	Storage Temperature-65°C to +150°C
Ambient Operating Temperature-40°C to +85°C	Power Dissipation See Curves

CAUTION: Stresses above those listed in "Absolute Maximum Ratings" may cause permanent damage to the device. This is a stress only rating and operation of the device at these or any other conditions above those indicated in the operational sections of this specification is not implied.

IMPORTANT NOTE: All parameters having Min/Max specifications are guaranteed. Typical values are for information purposes only. Unless otherwise noted, all tests are at the specified temperature and are pulsed tests, therefore: $T_J = T_C = T_A$

Electrical Specifications $V_H = 10\text{V}$, $V_L = -5\text{V}$, $E_N = 3\text{V}$, unless otherwise specified.

PARAMETER	DESCRIPTION	CONDITION	MIN	TYP	MAX	UNIT
POWER SUPPLY						
I_S	Supply Current	$E_N = 3\text{V}$, $I_{N_X} = 0\text{V}$		750	1200	μA
		$E_N = 3\text{V}$, $I_{N_X} = 3\text{V}$		250	500	μA
I_{S_DIS}	Supply Current - Disabled	$E_N = 0\text{V}$, $I_{N_X} = 0\text{V}$		3		μA
V_{LR}	V_L Range		-13		0	V
V_{HR}	V_H Range		5		18	V
V_H-V_L	Maximum $V_H - V_L$ Range		0		18	V
INPUT						
V_{IH}	Logic '1' Input Voltage		2.0			V
I_{IH}	Logic '1' Input Current			0.1	10	μA
V_{IL}	Logic '0' Input Voltage				0.8	V
I_{IL}	Logic '0' Input Current			0.1	10	μA
C_{IN}	Input Capacitance			3.5		pF
R_{IN}	Input Resistance			50		$\text{M}\Omega$
OUTPUT						
V_{OH}	V_{OUTL} High	$I_{N_X} = 10\text{V}$, $I_L = 10\text{mA}$	9.80	9.88		V
V_{OL}	V_{OUTL} Low	$I_{N_X} = 0\text{V}$, $I_L = -10\text{mA}$		-4.90	-4.88	V
R_{OH}	On Resistance V_H to OUT	$I_L = 50\text{mA}$		11	15	Ω
R_{OL}	On Resistance V_L to OUT	$I_L = 50\text{mA}$		11	15	Ω
I_{PEAK}	Peak Output Current			500		mA
I_L	Out Leakage Current			0.1	0.5	μA
SWITCHING CHARACTERISTICS						
t_R	Rise Time	$C_L = 500\text{pF}$		20	35	ns
t_F	Fall Time	$C_L = 500\text{pF}$		20	35	ns
t_{RFD}	T_R , T_F Matching	$C_L = 500\text{pF}$		5		ns
t_{D^+}	Turn On Delay	$C_L = 500\text{pF}$		55		ns
t_{D^-}	Turn Off Delay	$C_L = 500\text{pF}$		55		ns
t_{DD}	t_{D^+} , t_{D^-} , Matching	$C_L = 500\text{pF}$		5		ns
t_{EN}	Enable Time		9.8			μs
t_{DIS}	Disable Time		2.2			μs

Typical Performance Curves

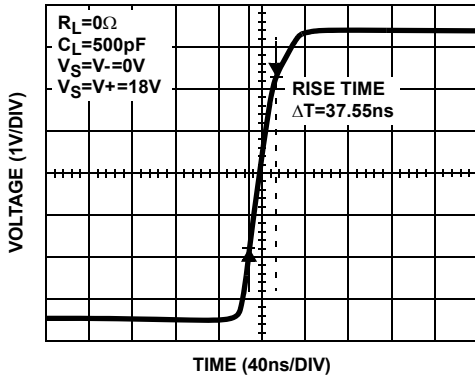

FIGURE 1. RISE TIME OUTPUT 6V_{p.p}

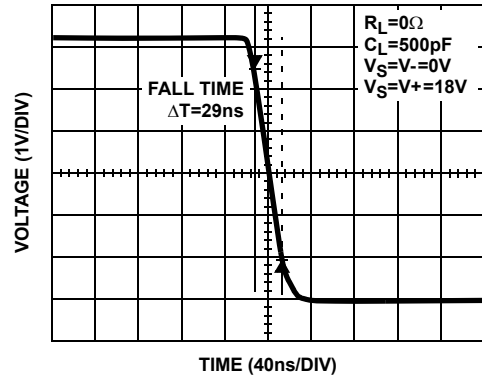

FIGURE 2. FALL TIME OUTPUT 6V_{p.p}

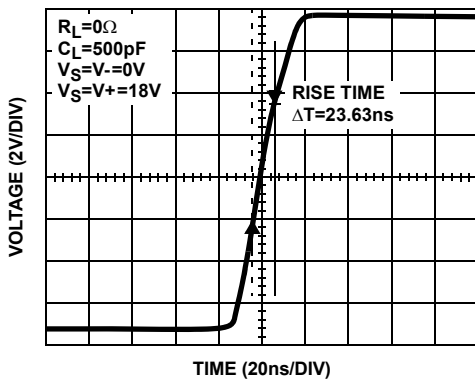

FIGURE 3. RISE TIME OUTPUT 12V_{p.p}

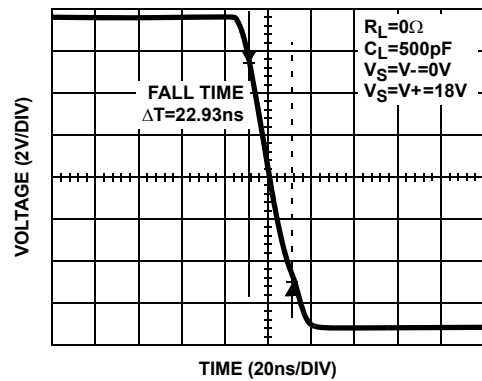

FIGURE 4. FALL TIME OUTPUT 12V_{p.p}

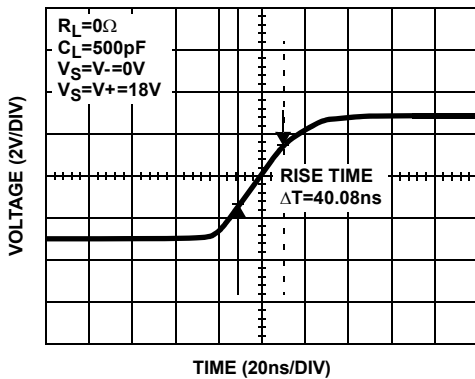

FIGURE 5. RISE TIME OUTPUT 5V_{p.p}

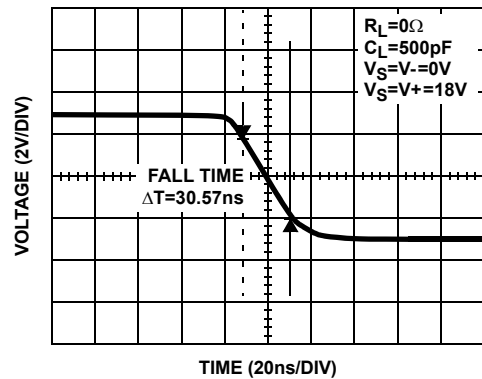

FIGURE 6. FALL TIME OUTPUT 5V_{p.p}

Typical Performance Curves (Continued)

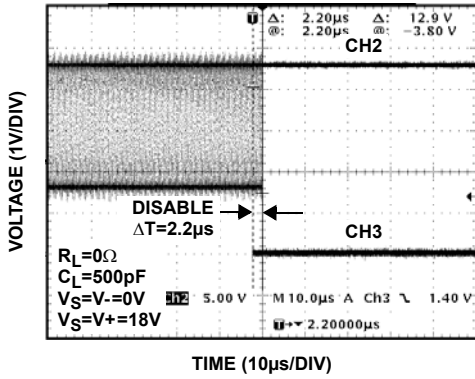

FIGURE 7. DISABLE RESPONSE

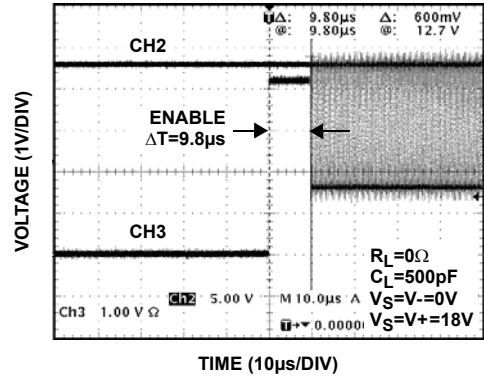

FIGURE 8. ENABLE RESPONSE

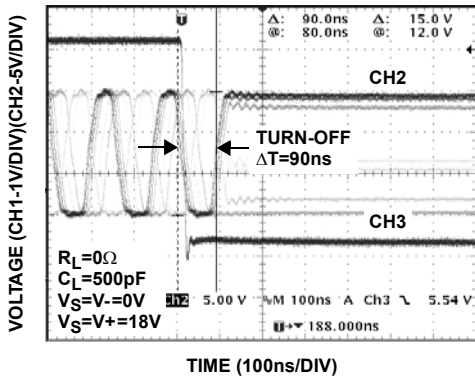

FIGURE 9. TURN-OFF (TRI)

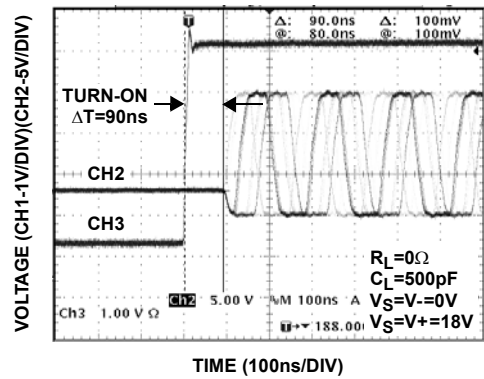

FIGURE 10. TURN-ON (TRI)

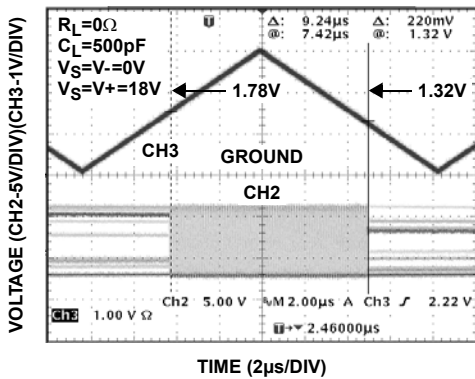

FIGURE 11. ENABLE/DISABLE THRESHOLD

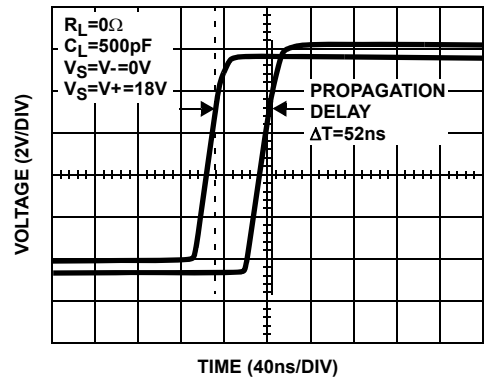

FIGURE 12. PROPAGATION DELAY

Typical Performance Curves (Continued)

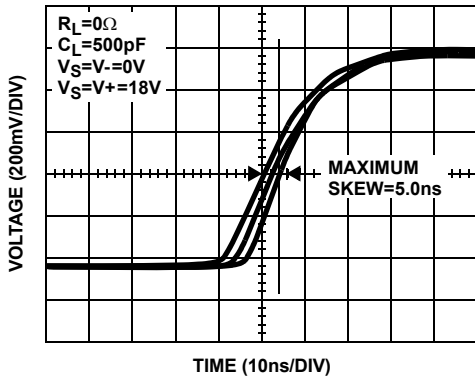

FIGURE 13. SKEW

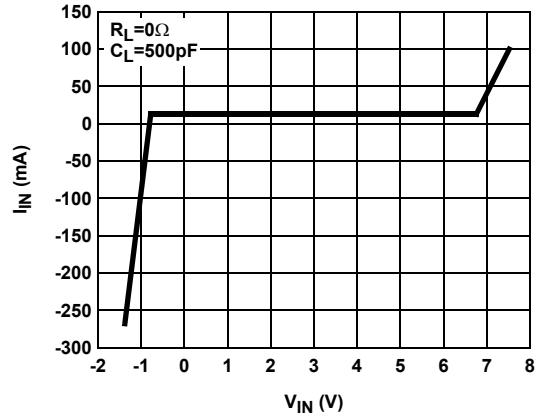

FIGURE 14. INPUT CURRENT vs VOLTAGE

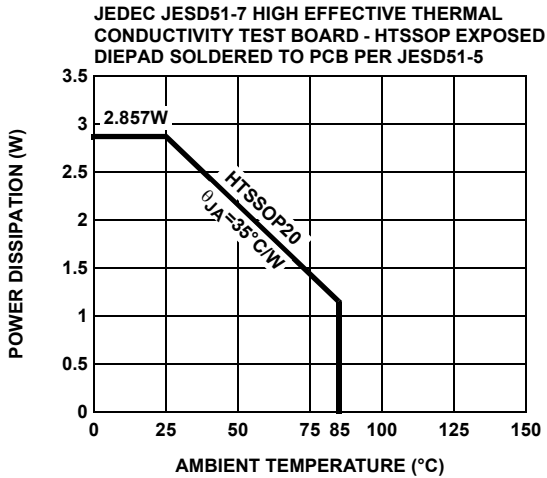

FIGURE 15. PACKAGE POWER DISSIPATION vs AMBIENT TEMPERATURE

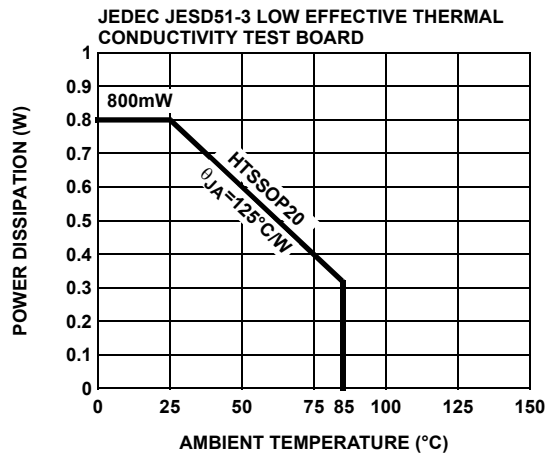

FIGURE 16. PACKAGE POWER DISSIPATION vs AMBIENT TEMPERATURE

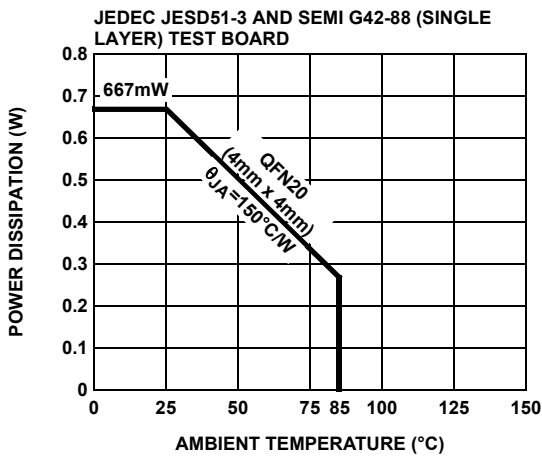

FIGURE 17. PACKAGE POWER DISSIPATION vs AMBIENT TEMPERATURE

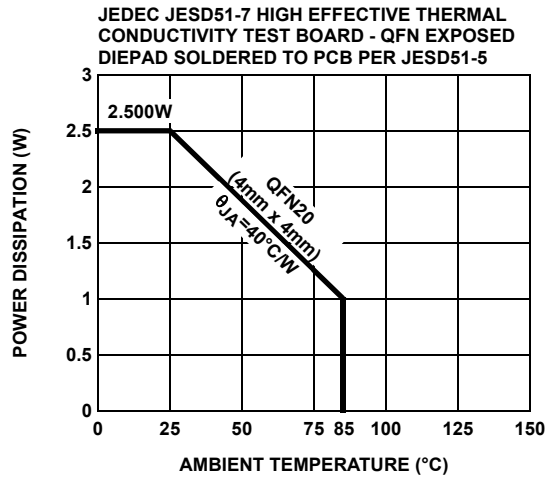
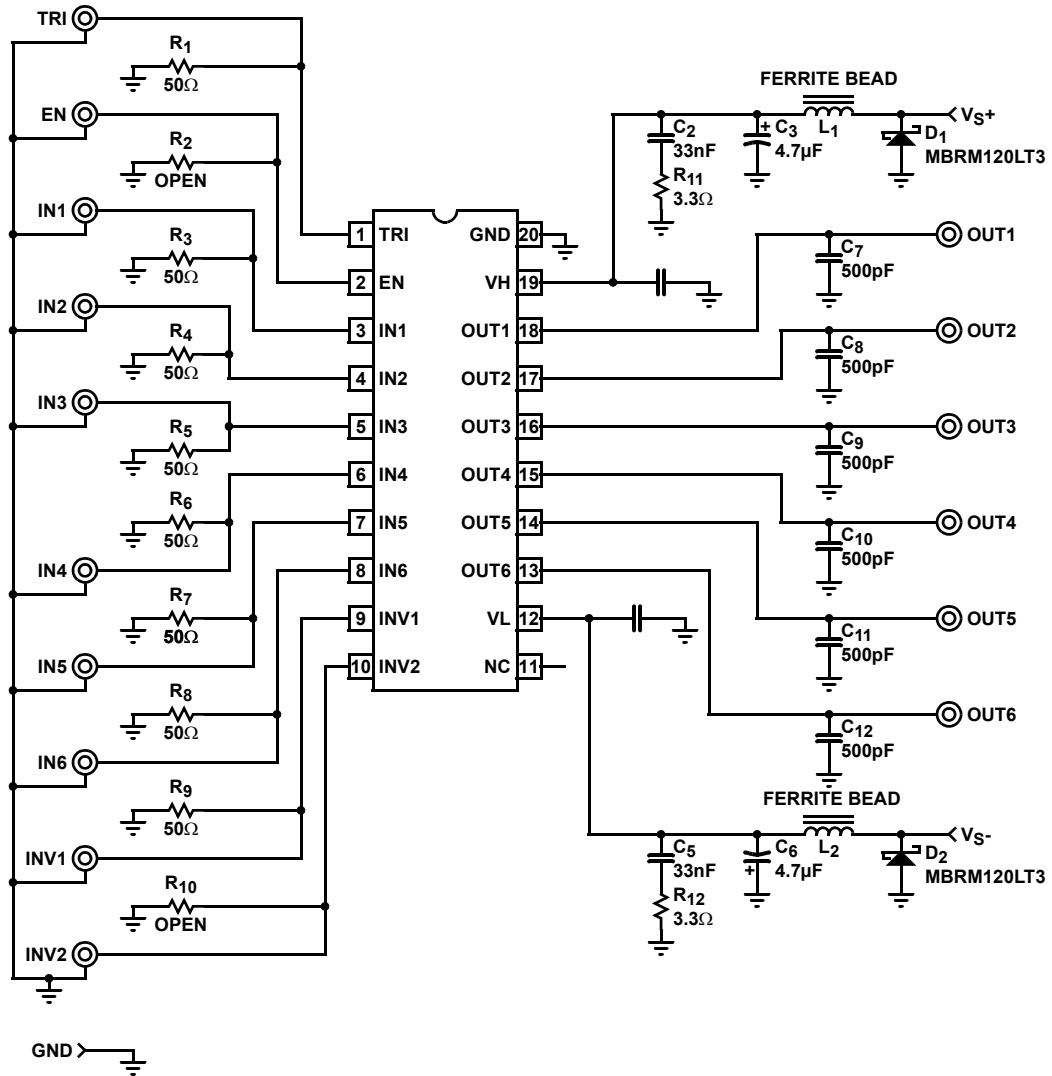
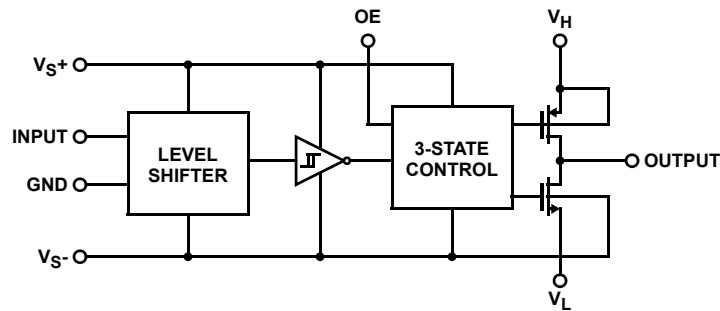

FIGURE 18. PACKAGE POWER DISSIPATION vs AMBIENT TEMPERATURE

EL5001 Test Board Circuit Layout



Block Diagram



Applications Information

The EL5001, a six channel high performance buffer, is directed primarily as a clock driver to LPTS LCD display applications. The six input channels are grouped into one group of four inputs and one group of two inputs each with a single pin (INV1 or INV2) to toggle the polarity from inverting to non-inverting. Each channel consists of a single N-channel low side driver and single P-channel high side driver. These 11Ω devices pull the output to either the high or low voltage on V_H and V_L respectively, depending on the logic input signal.

A common 3-state pin is available that when activated will pull all 6-channel outputs to the high impedance state. Enable and disable pins turn shutdown both inputs and outputs. Timing plots for 3-state, enable, and disable functions are included in the characterization documentation.

The EL5001 is available in either a 20-pin HTSSOP or QFN (4mm x 4mm) packages to provide a choice for power dissipation considerations.

Supply Voltage and Input Compatibility

The EL5001 is designed to operate at a maximum potential range from 0V to 18V. Because the EL5001 does not contain a true analog switch, the positive supply must always be 4V higher than the negative supply.

All input pins are compatible with both 3V and 5V CMOS signals. With the positive supply set to $V_S = 5V$ the EL5001 is compatible with TTL inputs.

Power Supply Bypassing

Due to the high switching currents generated by the EL5001 power supply bypassing is very important on both the positive and negative supplies. A $4.7\mu F$ tantalum capacitor can be used in parallel with a $0.1\mu F$ low-inductance ceramic MLC capacitor. As with all bypass components, these should be placed as close as possible to the supply pins. We also recommend the V_L and V_H pins have some level of bypassing especially when the device is driving highly capacitive loads.

Power Dissipation Calculation

When switching at high speeds, or driving heavy loads, the EL5001 drive capability is limited by the rise in die temperature brought about by internal power dissipation. For reliable operation die temperature must be kept below T_{JMAX} ($125^\circ C$). It is necessary to calculate the power dissipation for a given application prior to selecting package type.

Power dissipation may be calculated:

$$PD = (V_S \times I_S) + \sum \frac{4}{1} (C_{INT} \times V_S^2 \times f) + (C_L \times V_{OUT}^2 \times f)$$

where:

V_S = Total power supply to the EL5001 (from V_S+ to V_S-)

V_{OUT} = Swing on the output ($V_H - V_L$)

C_L = Load capacitance

C_{INT} = Internal load capacitance (80pF max)

I_S = Quiescent supply current (3mA max)

f = Frequency

Having obtained the application's power dissipation, the maximum junction temperature can be calculated:

$$T_{JMAX} = T_{MAX} + \theta_{JA} \times PD$$

where:

T_{JMAX} = Maximum junction temperature ($125^\circ C$)

T_{MAX} = Maximum ambient operating temperature

PD = Power dissipation calculated above

θ_{JA} = Thermal resistance, junction to ambient, of the application (package + PCB combination)

All Intersil U.S. products are manufactured, assembled and tested utilizing ISO9001 quality systems. Intersil Corporation's quality certifications can be viewed at www.intersil.com/design/quality

Intersil products are sold by description only. Intersil Corporation reserves the right to make changes in circuit design, software and/or specifications at any time without notice. Accordingly, the reader is cautioned to verify that data sheets are current before placing orders. Information furnished by Intersil is believed to be accurate and reliable. However, no responsibility is assumed by Intersil or its subsidiaries for its use; nor for any infringements of patents or other rights of third parties which may result from its use. No license is granted by implication or otherwise under any patent or patent rights of Intersil or its subsidiaries.

For information regarding Intersil Corporation and its products, see www.intersil.com