

# SMD Power Inductor CD30D22

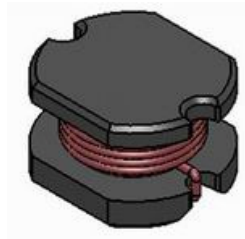

Halogen  
Free



## Description

- Ferrite drum core construction.
- Magnetically unshielded.
- L × W × H: 3.8 × 3.3 × 2.5mm Max.
- Product weight : 0.07g (Ref.)
- Moisture Sensitivity Level: 1
- RoHS compliance.
- Halogen Free available.

## Dimension - [mm]

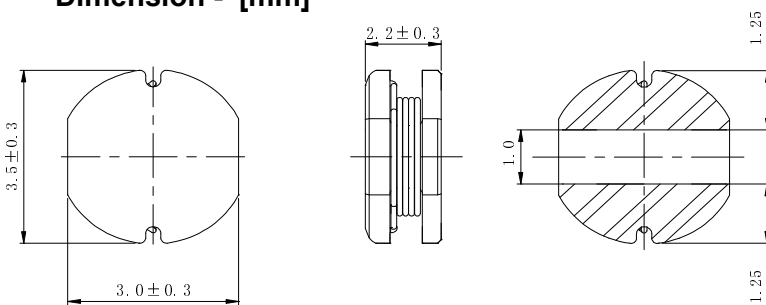

## Environmental Data

- Operating temperature range:  $-40^{\circ}\text{C} \sim +125^{\circ}\text{C}$  (including coil's self temperature rise)
- Storage temperature range:  $-40^{\circ}\text{C} \sim +125^{\circ}\text{C}$
- Solder reflow temperature:  $260^{\circ}\text{C}$  peak.

## Packaging

- Carrier tape and reel packaging.
- 13.0" diameter reel
- 3000pcs per reel

## Land pattern and Schematics - [mm]

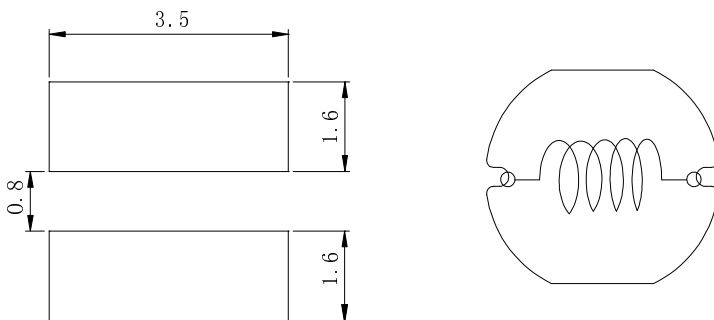

## Applications

- Ideally used in Mobilephone, PDA, MP3, DSC/DVC, portable DVD etc as DC-DC Converter inductors.

# SMD Power Inductor CD30D22



## Electrical Characteristics

Part No.	Stamp	Inductance [ $\mu$ H] [Within] ※1	D.C.R. ( $\Omega$ ) [Max.] (Typ.) (at 25°C)	Saturation current (A) [Max.] (Typ.) (at 25°C) ※2	Temperature rise current (A) ※3
CD30D22HF-1R0MC	B	1.0 $\pm$ 20%	35.9m (28.7m)	3.36 (4.20)	3.46
CD30D22HF-1R5MC	C	1.5 $\pm$ 20%	48.7m (38.9m)	2.80 (3.50)	3.00
CD30D22HF-2R2MC	D	2.2 $\pm$ 20%	69.4m (55.5m)	2.08 (2.60)	2.00
CD30D22HF-3R3MC	E	3.3 $\pm$ 20%	111m (88.7m)	1.76 (2.20)	1.56
CD30D22HF-4R7MC	F	4.7 $\pm$ 20%	140m (112m)	1.49 (1.86)	1.42
CD30D22HF-5R6MC	G	5.6 $\pm$ 20%	153m (122m)	1.36 (1.70)	1.35
CD30D22HF-6R8MC	H	6.8 $\pm$ 20%	172m (137m)	1.28 (1.60)	1.28
CD30D22HF-8R2MC	J	8.2 $\pm$ 20%	265m (212m)	1.14 (1.42)	0.97
CD30D22HF-100MC	K	10 $\pm$ 20%	313m (250m)	1.02 (1.28)	0.95
CD30D22HF-120MC	L	12 $\pm$ 20%	338m (270m)	0.96 (1.20)	0.91
CD30D22HF-150MC	M	15 $\pm$ 20%	388m (310m)	0.83 (1.04)	0.83
CD30D22HF-180MC	N	18 $\pm$ 20%	507m (405m)	0.80 (1.00)	0.70
CD30D22HF-220MC	P	22 $\pm$ 20%	643m (514m)	0.69 (0.86)	0.66
CD30D22HF-270MC	Q	27 $\pm$ 20%	730m (584m)	0.65 (0.81)	0.58
CD30D22HF-330MC	R	33 $\pm$ 20%	915m (732m)	0.57 (0.71)	0.49
CD30D22HF-390MC	S	39 $\pm$ 20%	1.07 (851m)	0.51 (0.64)	0.48
CD30D22HF-470MC	T	47 $\pm$ 20%	1.23 (980m)	0.49 (0.62)	0.39
CD30D22HF-680MC	U	68 $\pm$ 20%	1.82 (1.51)	0.41 (0.51)	0.37
CD30D22HF-101MC	V	100 $\pm$ 20%	2.79 (2.32)	0.33 (0.41)	0.30
CD30D22HF-151MC	X	150 $\pm$ 20%	4.62 (3.85)	0.26 (0.33)	0.22
CD30D22HF-221MC	Y	220 $\pm$ 20%	5.94 (4.95)	0.23 (0.29)	0.19

※1 Measuring frequency: 100 kHz 1V

※2 Saturation current: This indicates the value of D.C. current when the inductance becomes 10% lower than its initial value.

※3 Temperature rise current: The actual value of D.C. current when the temperature of coil becomes  $\Delta T=40^{\circ}\text{C}$  ( $T_a=20^{\circ}\text{C}$ ).

# SMD Power Inductor CD30D22



## Saturation Current & Temperature Rise Graph

— L (25°C)    —  $\Delta T$

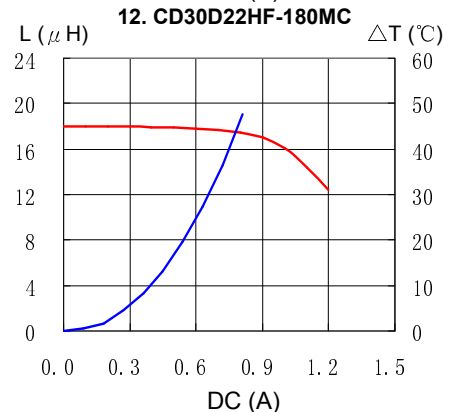
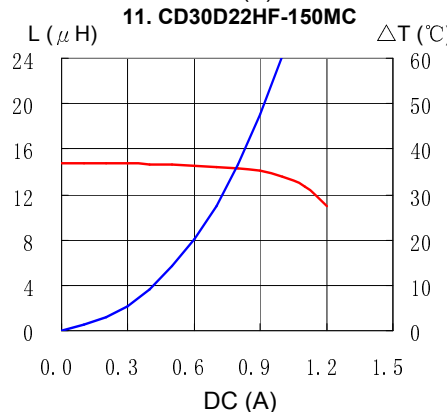
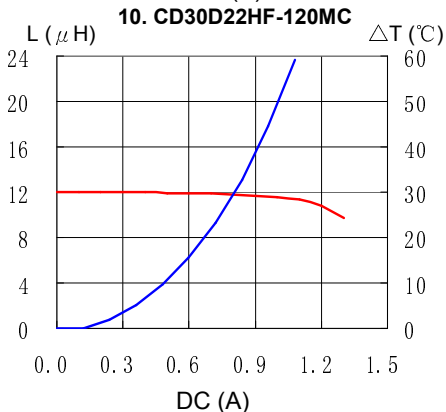
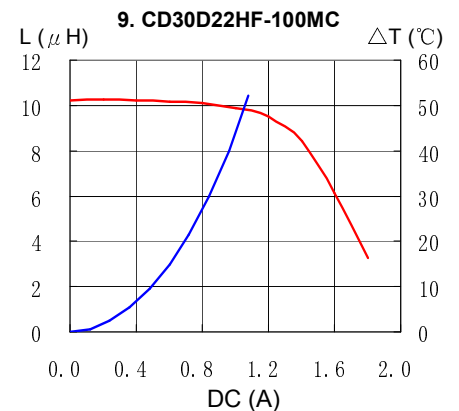
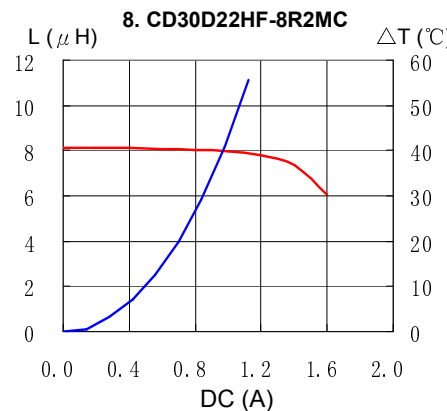
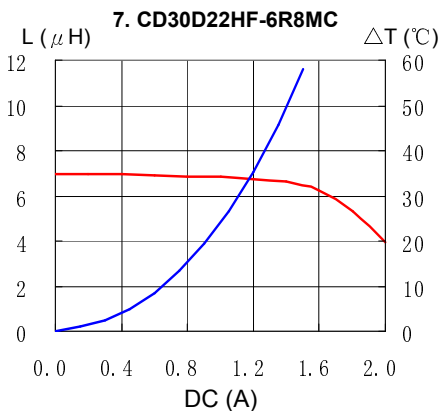
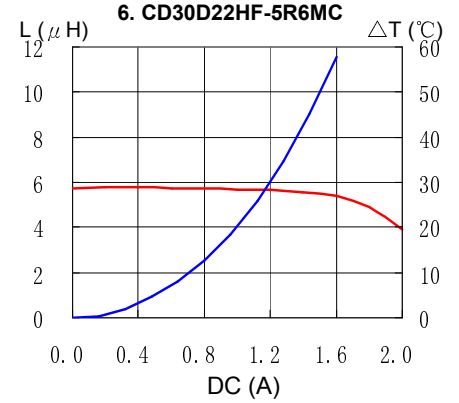
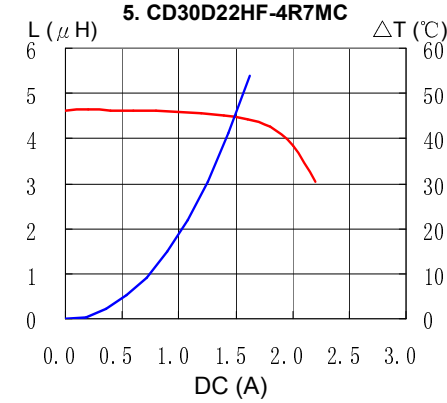
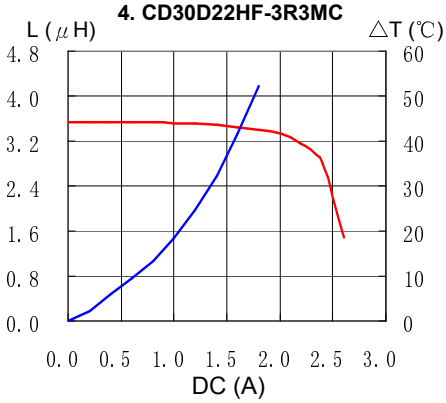
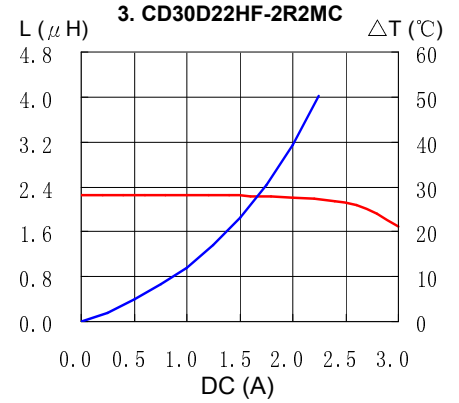
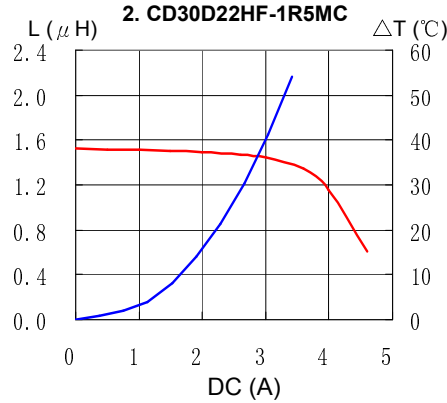
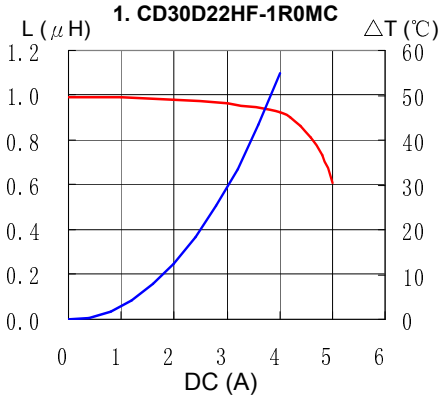

# SMD Power Inductor CD30D22



## Saturation Current & Temperature Rise Graph

— L (25°C)    —  $\Delta T$

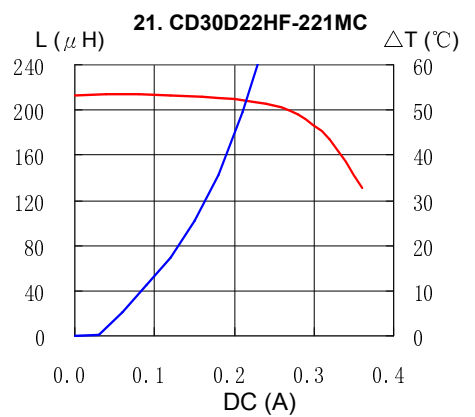
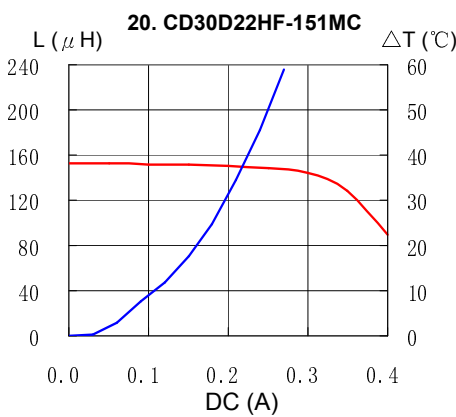
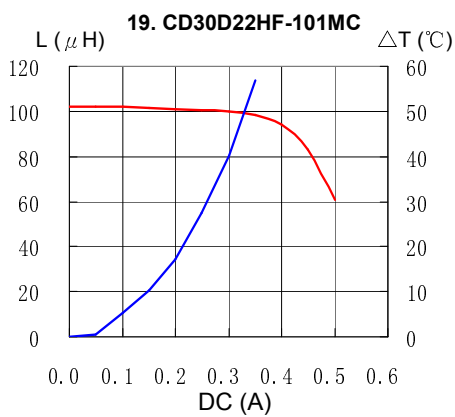
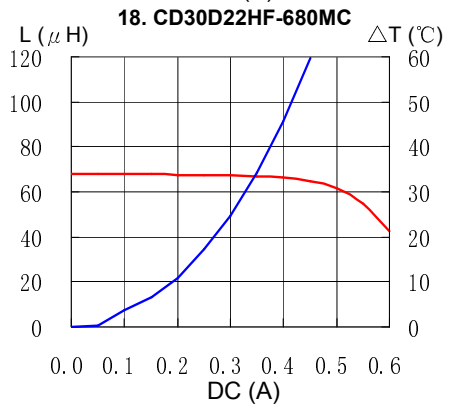
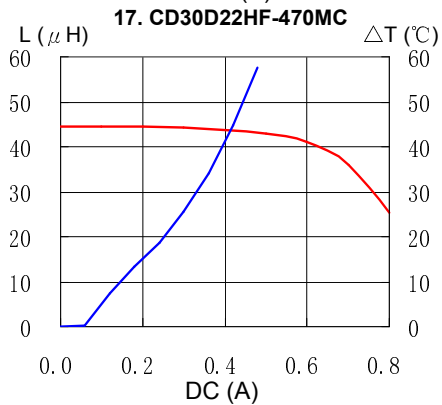
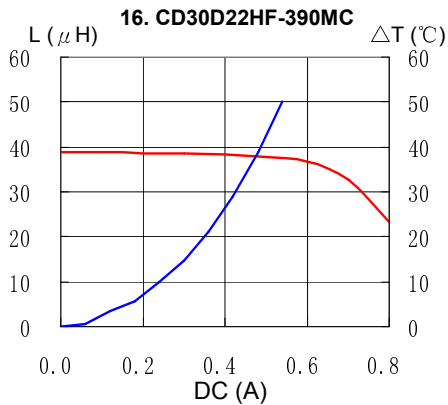
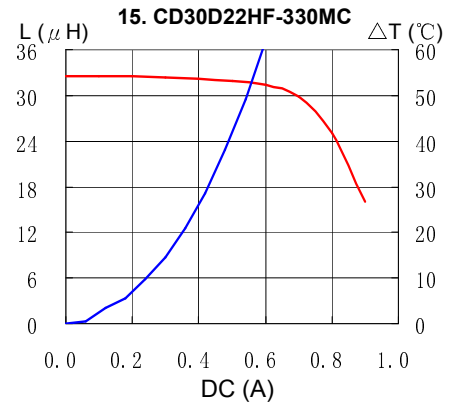
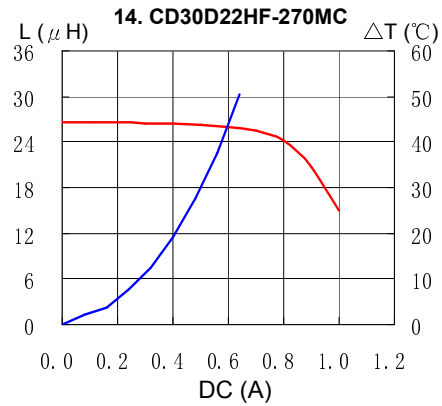
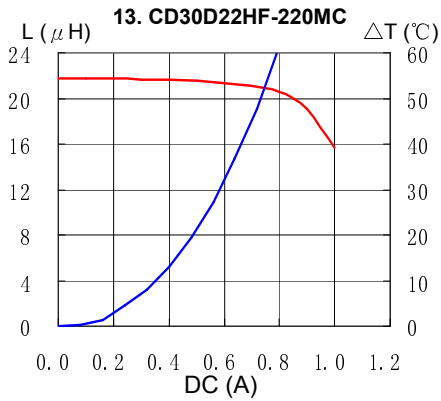

# SMD Power Inductor CD30D22



## Solder Reflow Condition

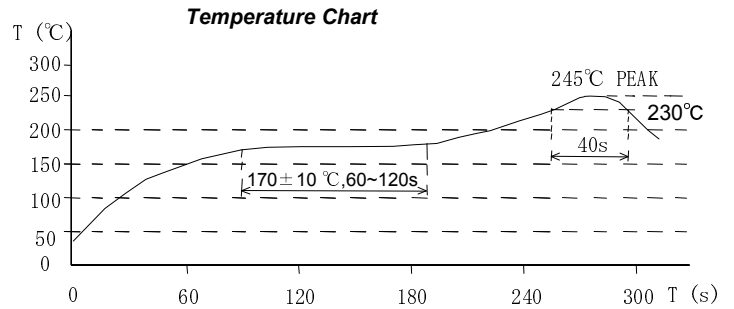
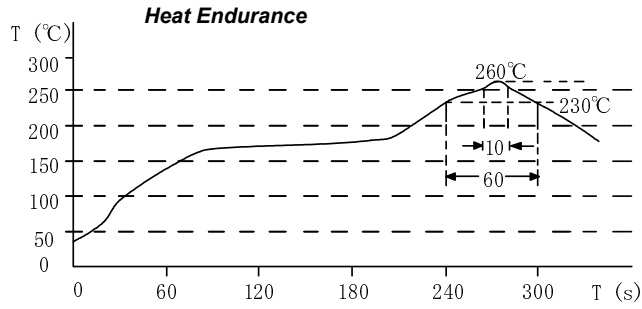

Please refer to the sales offices on our website - <http://www.sumida.com>

**Hong Kong**  
Tel.+852-2880-6781  
FAX.+852-2565-9600  
[sales@hk.sumida.com](mailto:sales@hk.sumida.com)

**Saitama(Japan)**  
Tel.+81-48-691-7300  
FAX.+81-48-691-7340  
[sales@jp.sumida.com](mailto:sales@jp.sumida.com)

**Chicago**  
Tel.+1-847-545-6700  
FAX. +1-847-545-6720  
[sales@us.sumida.com](mailto:sales@us.sumida.com)

**Shanghai**  
Tel.+86-21-5836-3299  
FAX.+86-21-5836-3266  
[shanghai.sales@cn.sumida.com](mailto:shanghai.sales@cn.sumida.com)

**Seoul**  
Tel.+82-2-6237-0777  
FAX.+82-2-6237-0778  
[sales@kr.sumida.com](mailto:sales@kr.sumida.com)

**Oberzell**  
Tel.+49-8591-937-0  
FAX. +49-8591-937-103  
[contact@eu.sumida.com](mailto:contact@eu.sumida.com)

**Shenzhen**  
Tel.+86-755-8291-0228  
FAX.+86-755-8291-0338  
[shenzhen.sales@cn.sumida.com](mailto:shenzhen.sales@cn.sumida.com)

**Singapore**  
Tel.+65-6296-3388  
FAX.+65-6841-4426  
[sales@sg.sumida.com](mailto:sales@sg.sumida.com)

**Neumarkt**  
Tel.+49-9181-4509-110  
FAX. +49-9181-4509-310  
[infocomp@eu.sumida.com](mailto:infocomp@eu.sumida.com)

**Taipei**  
Tel.+886-2-8751-2737  
FAX.+886-2-8751-2738  
[sales@tw.sumida.com](mailto:sales@tw.sumida.com)

**San Jose**  
Tel.+1-408-321-9660  
FAX.+1-408-321-9308  
[sales@us.sumida.com](mailto:sales@us.sumida.com)