

# High Gain 7.29dBi Ceramic Chip Antenna (2450MHz)



ACAG0801-2450-T



8.0 x 1.0 x 1.0mm  
RoHS/RoHS II Compliant  
MSL = 1

## FEATURES

- High gain of 7.29 dBi
- Made using LTCC (low temperature co-fired ceramic) technology
- Compact 8.0 x 1.0 x 1.0mm
- High efficiency
- Omni-directional

## APPLICATIONS

- Wifi
- Bluetooth
- ZigBee
- ISM applications
- IoT and wearable
- Remote Technology
- M2M

## ELECTRICAL CHARACTERISTICS

Item	Spec
Centre Frequency (No matching)	2857 MHz
Centre Frequency (After matching)	2450 MHz
Bandwidth	180 MHz typ
VSWR	≤2.0
Impedance	50Ω
Gain	7.29 dBi
Azimuth	Omni-directional
Polarization	Linear
Operating Temperature range	-40°C ~+ 85°C

## MECHANICAL DIMENSIONS

Antenna Dimensions

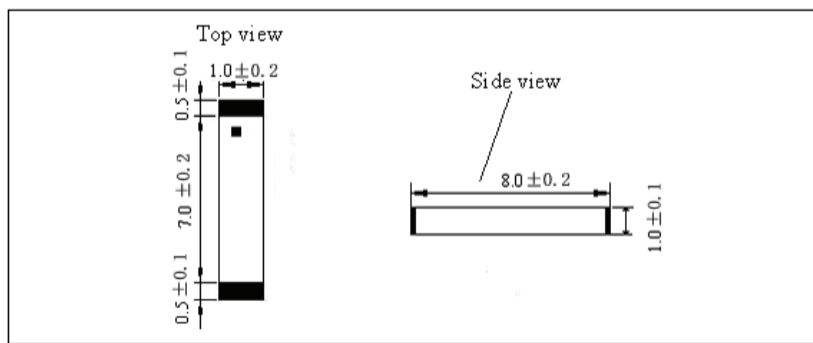

Layout Dimensions

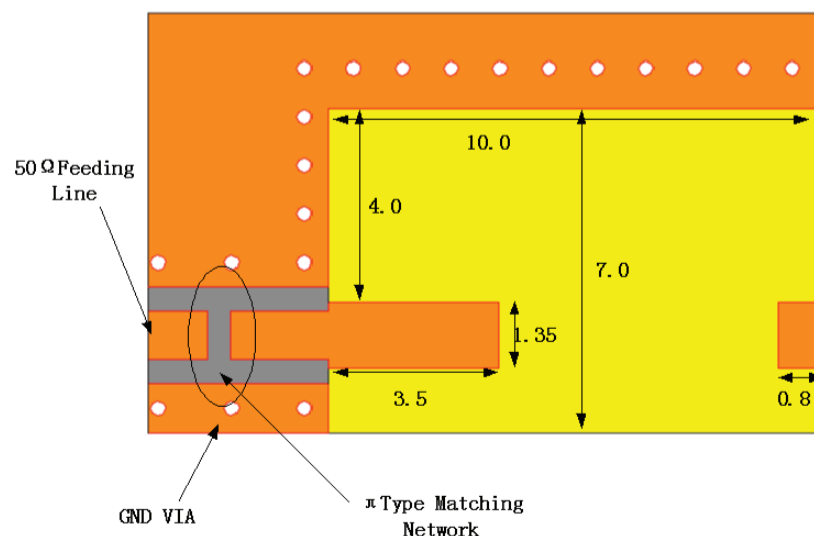

Dimensions (mm)

# High Gain 7.29dBi Ceramic Chip Antenna (2450MHz)

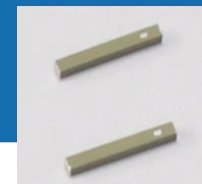

ACAG0801-2450-T



8.0 x 1.0 x 1.0mm  
RoHS/RoHS II Compliant  
MSL = 1

## EVALUATION BOARD AND MATCHING CIRCUITS

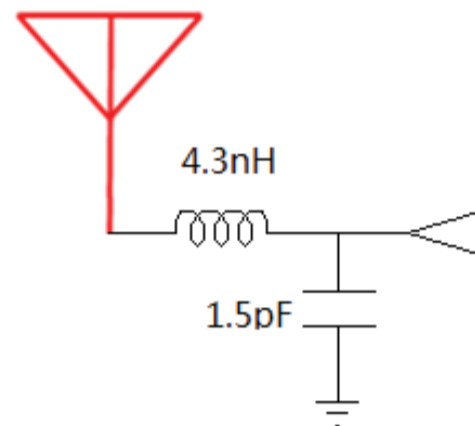
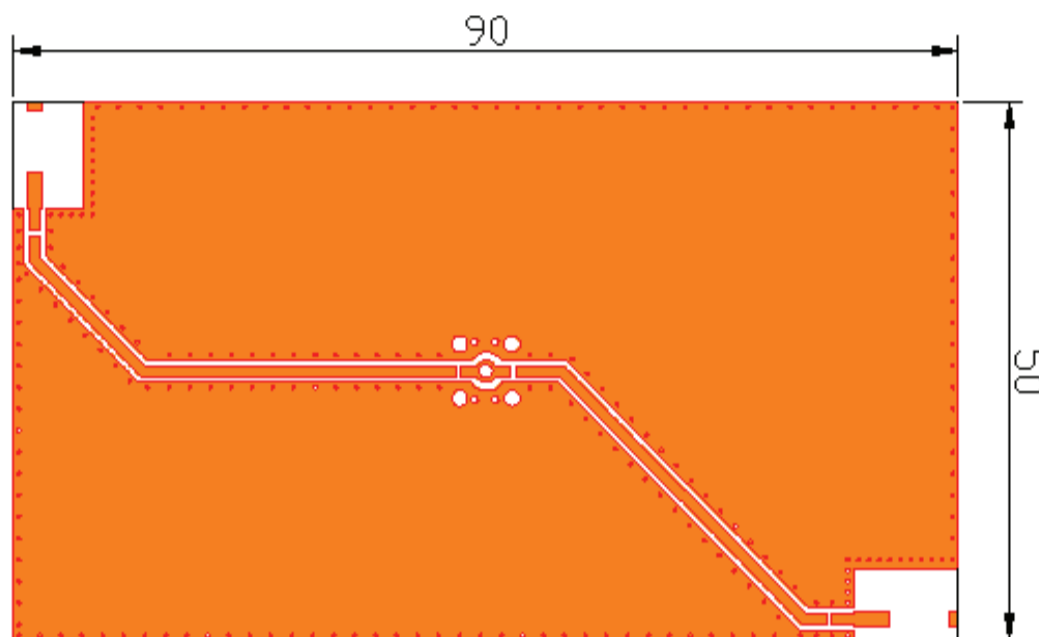

## ANTENNA RESPONSE – SMITH CHART AND RETURN LOSS S11

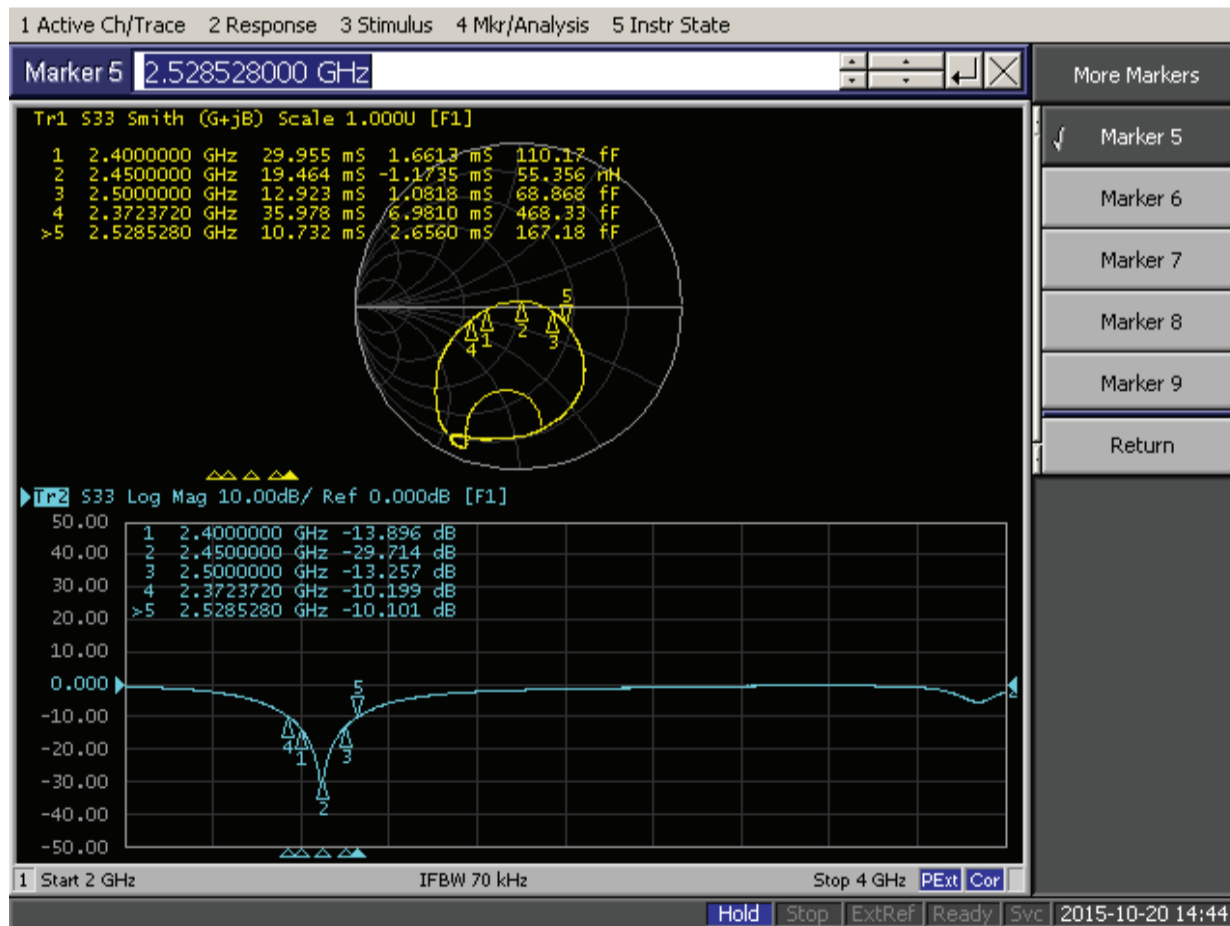

# High Gain 7.29dBi Ceramic Chip Antenna (2450MHz)

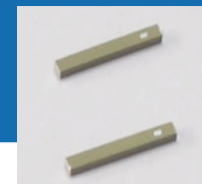

ACAG0801-2450-T



8.0 x 1.0 x 1.0mm  
RoHS/RoHS II Compliant  
MSL = 1

## RADIATION PATTERNS

### Coordinates

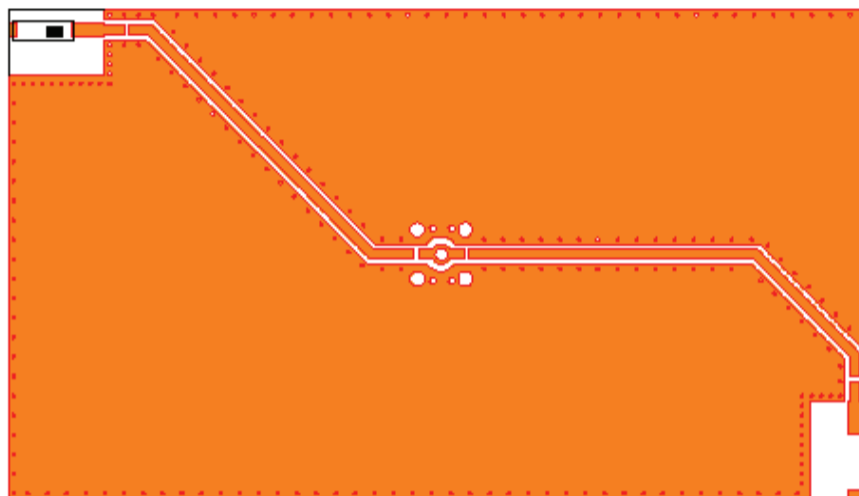
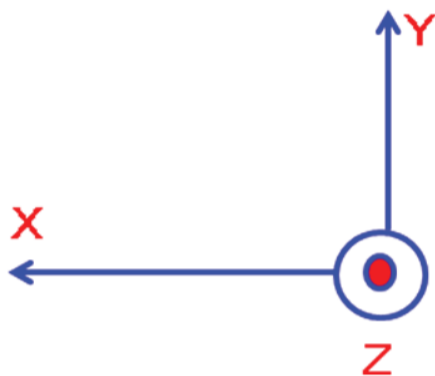

X-Z Plane

Y-Z Plane

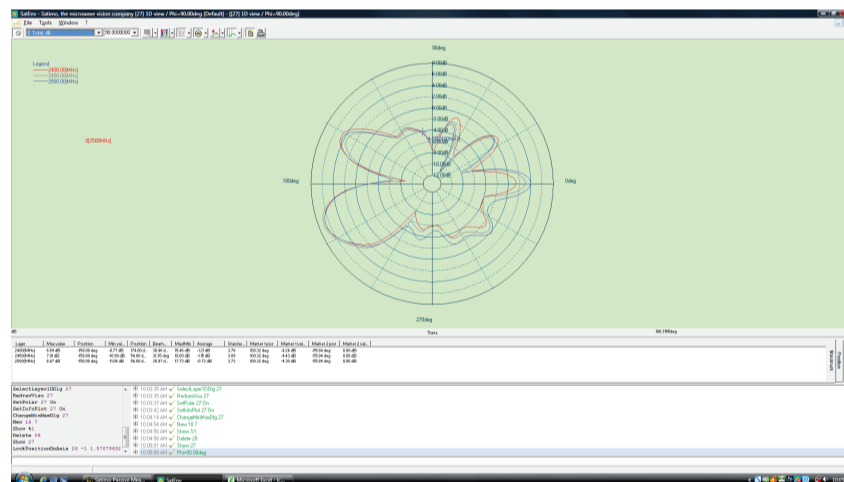
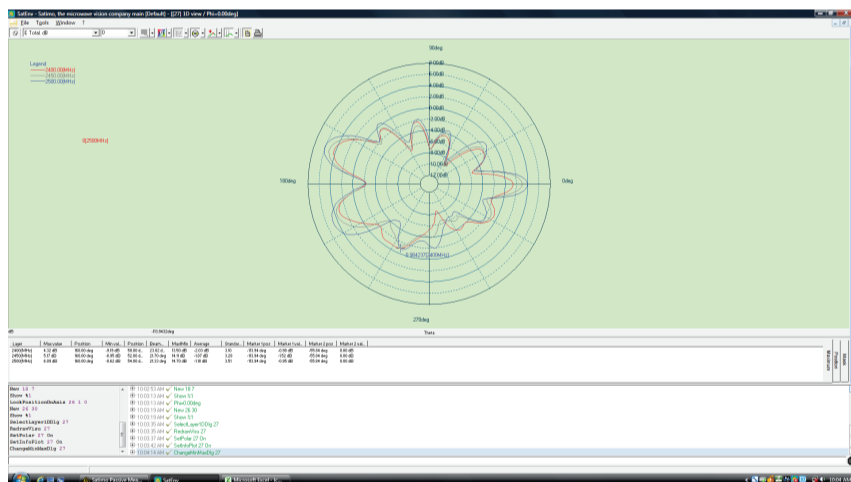

X-Y Plane

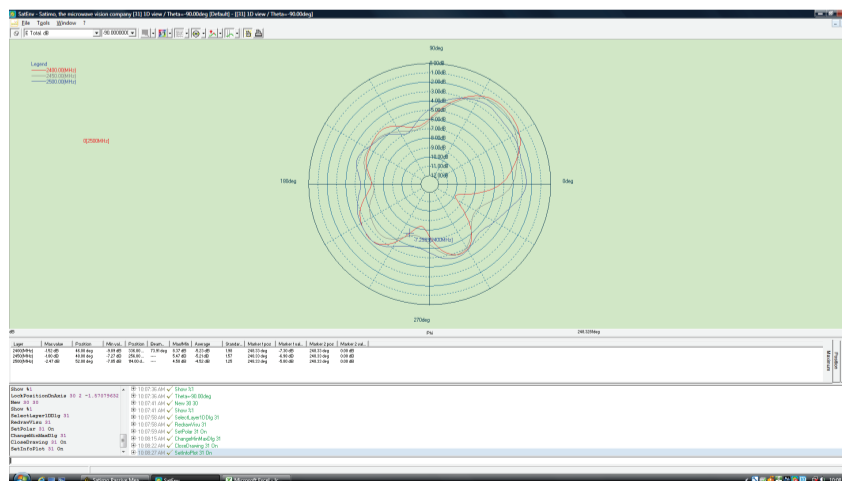

REVISED: 06.21.2018

# High Gain 7.29dBi Ceramic Chip Antenna (2450MHz)



ACAG0801-2450-T



8.0 x 1.0 x 1.0mm  
RoHS/RoHS II Compliant  
MSL = 1

## 3D PATTERNS

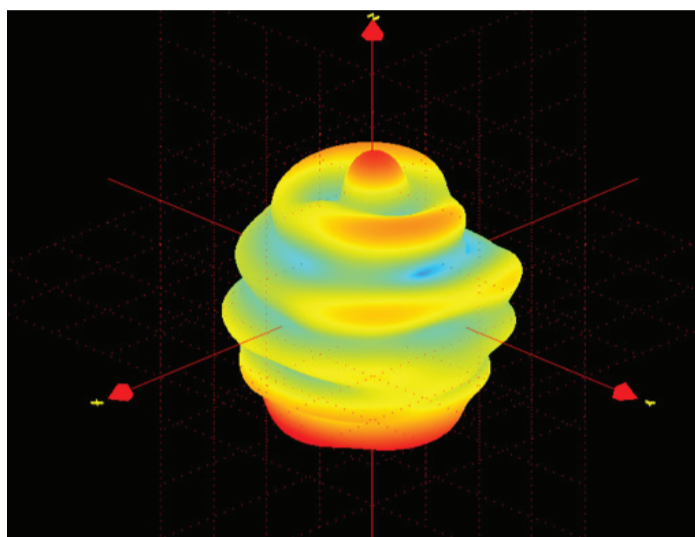

Frequency (MHz)	2400	2450	2500
Avg. Gain (dBi)	-1.30	-1.15	-1.26
Peak Gain (dBi)	6.67	7.29	6.69
Efficiency (%)	72.6	74.5	72.8

## REFLOW SOLDERING STANDARD CONDITION

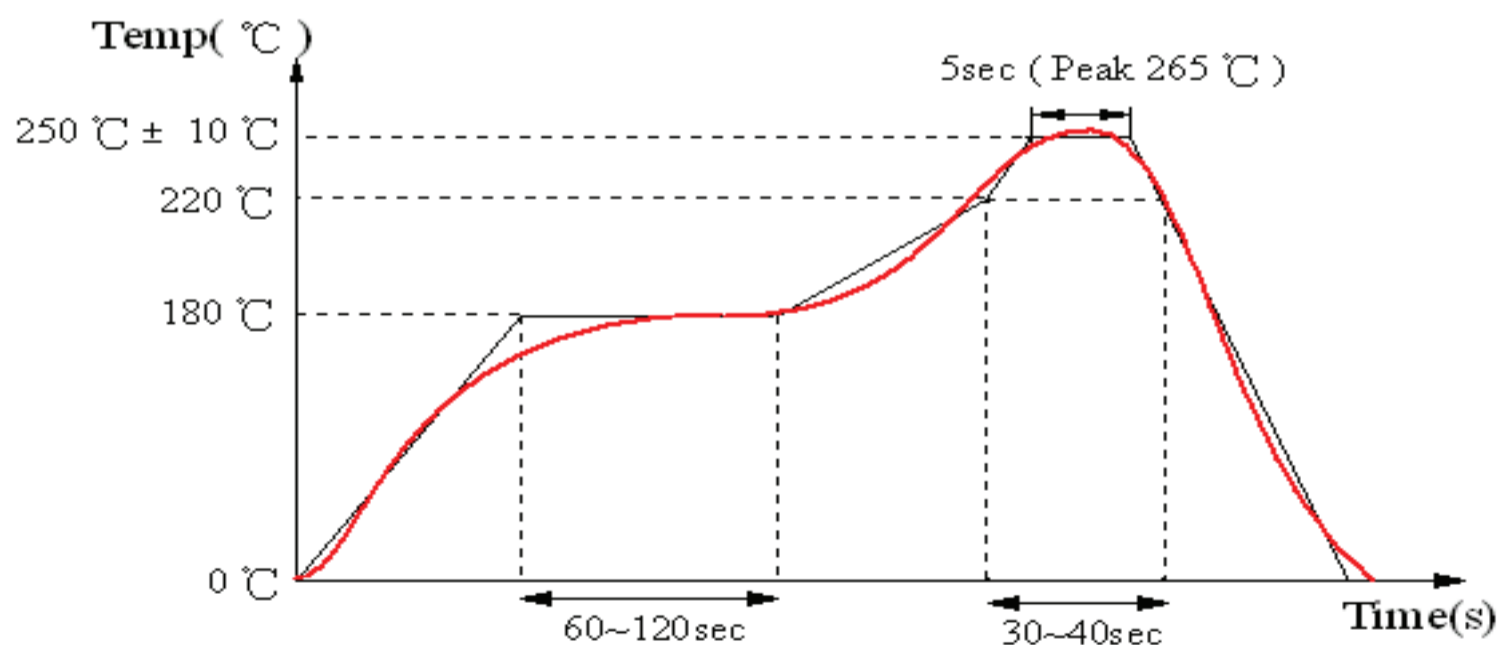

# High Gain 7.29dBi Ceramic Chip Antenna (2450MHz)



ACAG0801-2450-T



8.0 x 1.0 x 1.0mm  
RoHS/RoHS II Compliant  
MSL = 1

## PACKAGING

Package Type	Quantity/Size
Inner Box	1500 pcs/reel
Centre Frequency (After matching)	15000 pcs/carton
Carton	330 x 210 x 210 mm

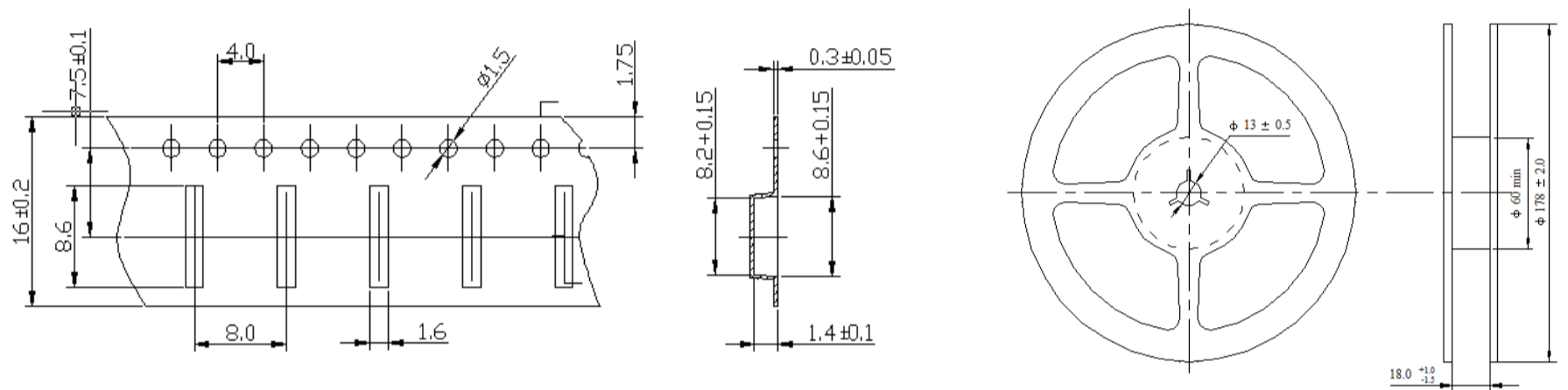

Storage Temperature Range : <30 degree C, Humidity : <60%RH

MSL - 1

Oxidizable, 12 months in a vacuum sealed bag.

Once opened, please repack the unused items within 168 hours by re-seal package treatment.

Dimensions: mm

## CAUTIONS

### 1. Static voltage

Static voltage between signal & ground may cause deterioration & destruction of the component. Please avoid static voltage.

### 2. Ultrasonic cleaning

Ultrasonic vibration may cause deterioration & destruction of the component. Please avoid ultrasonic cleaning.

### 3. Soldering

Only leads of the component may be soldered. Please avoid soldering to any other part of the component, such as on the patterns as this will change the performance of the antenna.