

# NTD4969N

## MOSFET – Power, Single, N-Channel, DPAK/IPAK

30 V, 41 A

### Features

- Low  $R_{DS(on)}$  to Minimize Conduction Losses
- Low Capacitance to Minimize Driver Losses
- Optimized Gate Charge to Minimize Switching Losses
- Three Package Variations for Design Flexibility
- These Devices are Pb-Free, Halogen Free/BFR Free and are RoHS Compliant

### Applications

- CPU Power Delivery
- DC-DC Converters

### MAXIMUM RATINGS ( $T_J = 25^\circ\text{C}$ unless otherwise stated)

Parameter	Symbol	Value	Unit		
Drain-to-Source Voltage	$V_{DSS}$	30	V		
Gate-to-Source Voltage	$V_{GS}$	$\pm 20$	V		
Continuous Drain Current $R_{\theta JA}$ (Note 1)	$I_D$	$T_A = 25^\circ\text{C}$	12.7	A	
		$T_A = 100^\circ\text{C}$	9.0		
Power Dissipation $R_{\theta JA}$ (Note 1)	$P_D$	$T_A = 25^\circ\text{C}$	2.56	W	
		$T_A = 100^\circ\text{C}$			
Continuous Drain Current $R_{\theta JA}$ (Note 2)	$I_D$	$T_A = 25^\circ\text{C}$	9.4	A	
		$T_A = 100^\circ\text{C}$	6.6		
Power Dissipation $R_{\theta JA}$ (Note 2)	$P_D$	$T_A = 25^\circ\text{C}$	1.38	W	
		$T_A = 100^\circ\text{C}$			
Continuous Drain Current $R_{\theta JC}$ (Note 1)	$I_D$	$T_C = 25^\circ\text{C}$	41	A	
		$T_C = 100^\circ\text{C}$	29		
Power Dissipation $R_{\theta JC}$ (Note 1)	$P_D$	$T_C = 25^\circ\text{C}$	26.3	W	
		$T_C = 100^\circ\text{C}$			
Pulsed Drain Current	$t_p = 10\mu\text{s}$	$T_A = 25^\circ\text{C}$	$I_{DM}$	150	A
Current Limited by Package	$T_A = 25^\circ\text{C}$	$I_{DmaxPkg}$	40	A	
Operating Junction and Storage Temperature	$T_J, T_{STG}$	-55 to +175		$^\circ\text{C}$	
Source Current (Body Diode)	$I_S$	24		A	
Drain to Source $dV/dt$	$dV/dt$	6.0		V/ns	
Single Pulse Drain-to-Source Avalanche Energy ( $T_J = 25^\circ\text{C}$ , $V_{DD} = 24\text{ V}$ , $V_{GS} = 10\text{ V}$ , $I_L = 19\text{ A}_{pk}$ , $L = 0.1\text{ mH}$ , $R_G = 25\ \Omega$ )	EAS	18		mJ	
Lead Temperature for Soldering Purposes (1/8" from case for 10 s)	$T_L$	260		$^\circ\text{C}$	

Stresses exceeding those listed in the Maximum Ratings table may damage the device. If any of these limits are exceeded, device functionality should not be assumed, damage may occur and reliability may be affected.

1. Surface-mounted on FR4 board using 1 sq-in pad, 1 oz Cu.
2. Surface-mounted on FR4 board using the minimum recommended pad size.



ON Semiconductor®

<http://onsemi.com>

$V_{(BR)DSS}$	$R_{DS(ON)} \text{ MAX}$	$I_D \text{ MAX}$
30 V	9.0 m $\Omega$ @ 10 V	41 A
	19 m $\Omega$ @ 4.5 V	

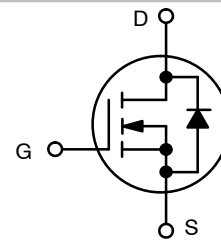

N-CHANNEL MOSFET

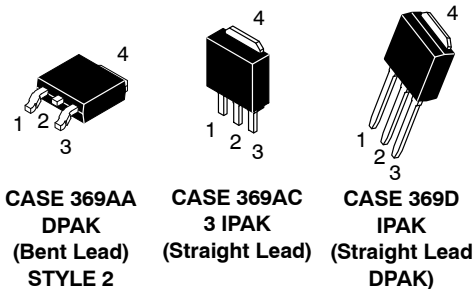

### MARKING DIAGRAMS & PIN ASSIGNMENTS

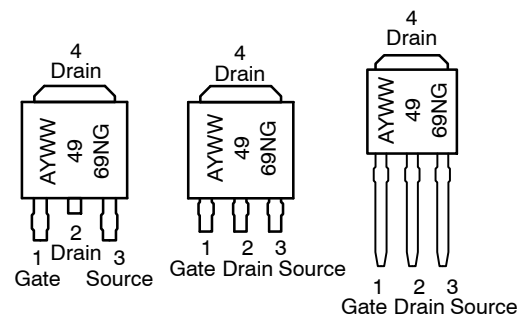

A = Assembly Location  
 Y = Year  
 WW = Work Week  
 4969N = Device Code  
 G = Pb-Free Package

### ORDERING INFORMATION

See detailed ordering and shipping information in the package dimensions section on page 3 of this data sheet.

# NTD4969N

## THERMAL RESISTANCE MAXIMUM RATINGS

Parameter	Symbol	Value	Unit
Junction-to-Case (Drain)	$R_{\theta JC}$	5.7	°C/W
Junction-to-TAB (Drain)	$R_{\theta JC-TAB}$	4.3	
Junction-to-Ambient – Steady State (Note 3)	$R_{\theta JA}$	58.6	
Junction-to-Ambient – Steady State (Note 4)	$R_{\theta JA}$	108.6	

- Surface-mounted on FR4 board using 1 sq-in pad, 1 oz Cu.
- Surface-mounted on FR4 board using the minimum recommended pad size.

## ELECTRICAL CHARACTERISTICS ( $T_J = 25^\circ\text{C}$ unless otherwise specified)

Parameter	Symbol	Test Condition	Min	Typ	Max	Unit
-----------	--------	----------------	-----	-----	-----	------

### OFF CHARACTERISTICS

Drain-to-Source Breakdown Voltage	$V_{(BR)DSS}$	$V_{GS} = 0\text{ V}, I_D = 250\ \mu\text{A}$	30			V
Drain-to-Source Breakdown Voltage Temperature Coefficient	$V_{(BR)DSS}/T_J$			17		mV/°C
Zero Gate Voltage Drain Current	$I_{DSS}$	$V_{GS} = 0\text{ V}, V_{DS} = 24\text{ V}$	$T_J = 25^\circ\text{C}$		1.0	$\mu\text{A}$
			$T_J = 125^\circ\text{C}$		10	
Gate-to-Source Leakage Current	$I_{GSS}$	$V_{DS} = 0\text{ V}, V_{GS} = \pm 20\text{ V}$			$\pm 100$	nA

### ON CHARACTERISTICS (Note 5)

Gate Threshold Voltage	$V_{GS(TH)}$	$V_{GS} = V_{DS}, I_D = 250\ \mu\text{A}$	1.5	1.8	2.5	V	
Negative Threshold Temperature Coefficient	$V_{GS(TH)}/T_J$			4.5		mV/°C	
Drain-to-Source On Resistance	$R_{DS(on)}$	$V_{GS} = 10\text{ V}$	$I_D = 30\text{ A}$		6.9	9.0	m $\Omega$
			$I_D = 15\text{ A}$		6.9		
		$V_{GS} = 4.5\text{ V}$	$I_D = 30\text{ A}$		13.6	19	
			$I_D = 15\text{ A}$		13.2		
Forward Transconductance	$g_{FS}$	$V_{DS} = 1.5\text{ V}, I_D = 30\text{ A}$		36		S	

### CHARGES, CAPACITANCES AND GATE RESISTANCE

Input Capacitance	$C_{ISS}$	$V_{GS} = 0\text{ V}, f = 1.0\text{ MHz}, V_{DS} = 15\text{ V}$		837		pF
Output Capacitance	$C_{OSS}$			347		
Reverse Transfer Capacitance	$C_{RSS}$			180		
Total Gate Charge	$Q_{G(TOT)}$	$V_{GS} = 4.5\text{ V}, V_{DS} = 15\text{ V}, I_D = 30\text{ A}$		9.0		nC
Threshold Gate Charge	$Q_{G(TH)}$			1.42		
Gate-to-Source Charge	$Q_{GS}$			2.8		
Gate-to-Drain Charge	$Q_{GD}$			4.8		
Total Gate Charge	$Q_{G(TOT)}$		$V_{GS} = 10\text{ V}, V_{DS} = 15\text{ V}, I_D = 30\text{ A}$		16.5	

### SWITCHING CHARACTERISTICS (Note 6)

Turn-On Delay Time	$t_{d(ON)}$	$V_{GS} = 4.5\text{ V}, V_{DS} = 15\text{ V}, I_D = 15\text{ A}, R_G = 3.0\ \Omega$		10		ns
Rise Time	$t_r$			27		
Turn-Off Delay Time	$t_{d(OFF)}$			13.3		
Fall Time	$t_f$			6.4		

- Pulse Test: pulse width  $\leq 300\ \mu\text{s}$ , duty cycle  $\leq 2\%$ .
- Switching characteristics are independent of operating junction temperatures.
- Assume terminal length of 110 mils.

# NTD4969N

## ELECTRICAL CHARACTERISTICS ( $T_J = 25^\circ\text{C}$ unless otherwise specified)

Parameter	Symbol	Test Condition	Min	Typ	Max	Unit
<b>SWITCHING CHARACTERISTICS</b> (Note 6)						
Turn-On Delay Time	$t_{d(ON)}$	$V_{GS} = 10\text{ V}, V_{DS} = 15\text{ V},$ $I_D = 15\text{ A}, R_G = 3.0\ \Omega$		6.5		ns
Rise Time	$t_r$			20.2		
Turn-Off Delay Time	$t_{d(OFF)}$			17.2		
Fall Time	$t_f$			4.2		

## DRAIN-SOURCE DIODE CHARACTERISTICS

Forward Diode Voltage	$V_{SD}$	$V_{GS} = 0\text{ V},$ $I_S = 30\text{ A}$	$T_J = 25^\circ\text{C}$		0.91	1.1	V
			$T_J = 125^\circ\text{C}$		0.82		
Reverse Recovery Time	$t_{RR}$	$V_{GS} = 0\text{ V}, dI_S/dt = 100\text{ A}/\mu\text{s},$ $I_S = 30\text{ A}$			20.8		ns
Charge Time	$t_a$				9.8		
Discharge Time	$t_b$				11		
Reverse Recovery Charge	$Q_{RR}$				8.0		nC

## PACKAGE PARASITIC VALUES

Source Inductance (Note 7)	$L_S$	$T_A = 25^\circ\text{C}$		2.85		nH
Drain Inductance, DPAK	$L_D$			0.0164		
Drain Inductance, IPAK (Note 7)	$L_D$			1.88		
Gate Inductance (Note 7)	$L_G$			4.9		
Gate Resistance	$R_G$			1.0	2.2	$\Omega$

5. Pulse Test: pulse width  $\leq 300\ \mu\text{s}$ , duty cycle  $\leq 2\%$ .
6. Switching characteristics are independent of operating junction temperatures.
7. Assume terminal length of 110 mils.

## ORDERING INFORMATION

Device	Package	Shipping <sup>†</sup>
NTD4969NT4G	DPAK (Pb-Free)	2500 / Tape & Reel
NTD4969N-1G	IPAK (Pb-Free)	75 Units / Rail
NTD4969N-35G	IPAK Trimmed Lead (Pb-Free)	75 Units / Rail

<sup>†</sup>For information on tape and reel specifications, including part orientation and tape sizes, please refer to our Tape and Reel Packaging Specifications Brochure, BRD8011/D.

TYPICAL PERFORMANCE CURVES

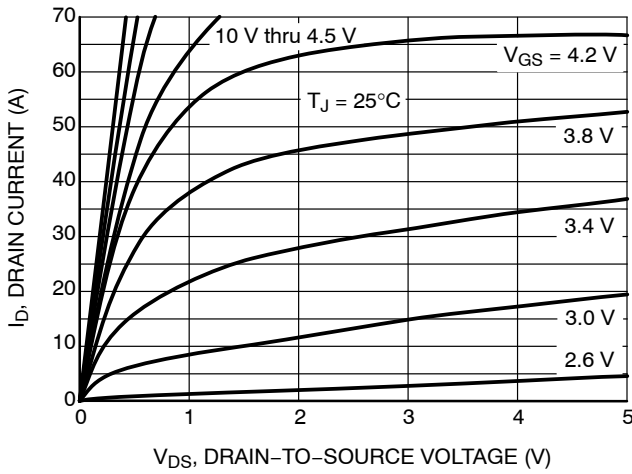

Figure 1. On-Region Characteristics

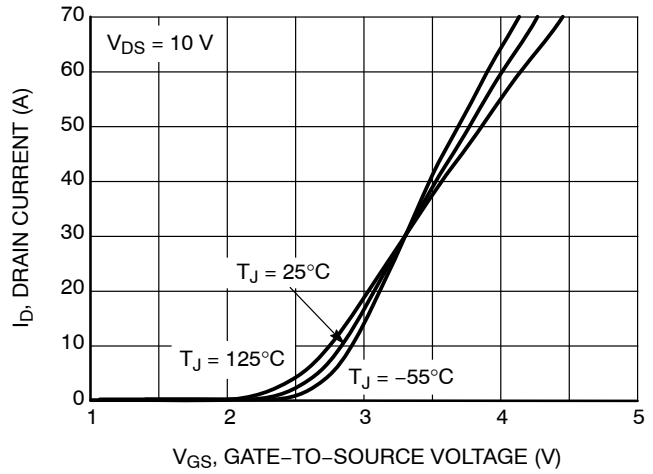

Figure 2. Transfer Characteristics

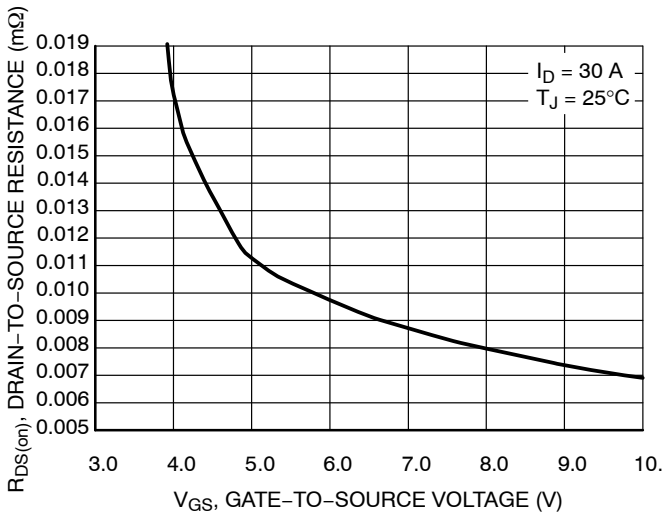

Figure 3. On-Resistance vs. Gate-to-Source Voltage

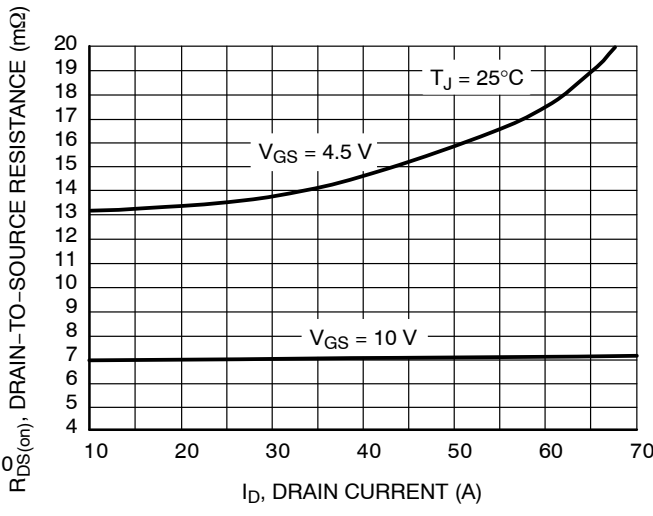

Figure 4. On-Resistance vs. Drain Current and Gate Voltage

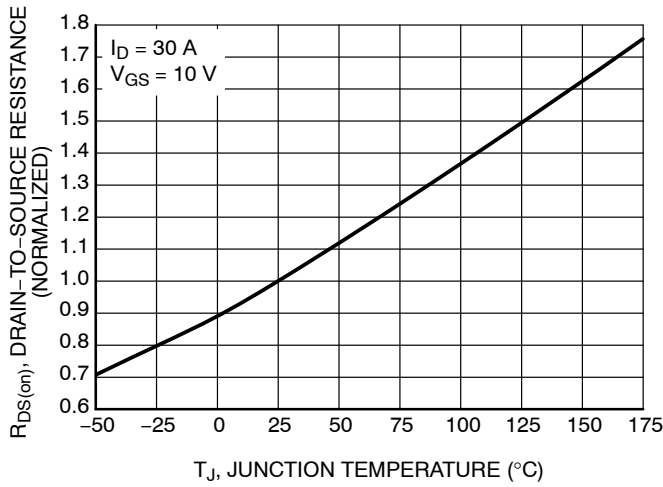

Figure 5. On-Resistance Variation with Temperature

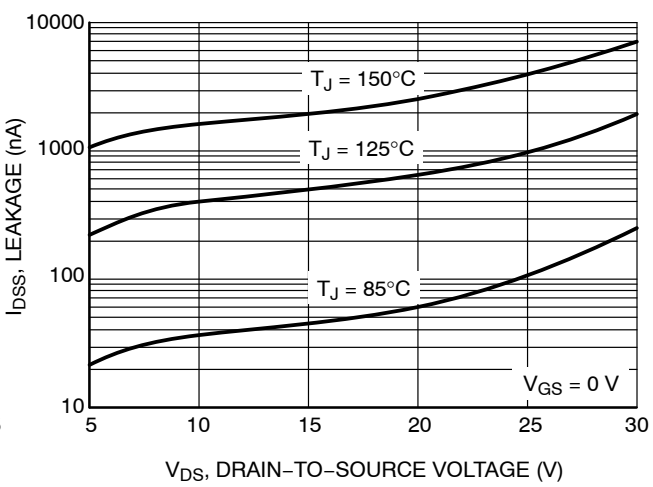

Figure 6. Drain-to-Source Leakage Current vs. Voltage

# NTD4969N

## TYPICAL PERFORMANCE CURVES

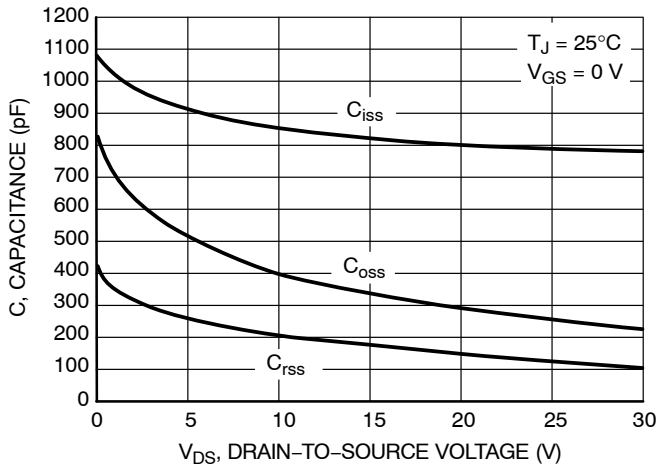

Figure 7. Capacitance Variation

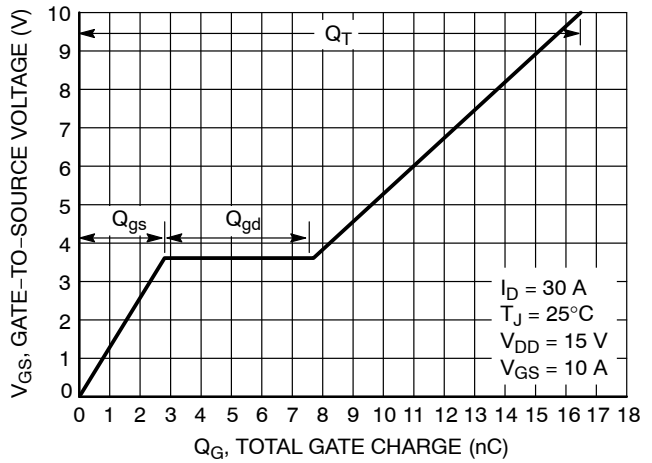

Figure 8. Gate-to-Source and Drain-to-Source Voltage vs. Total Charge

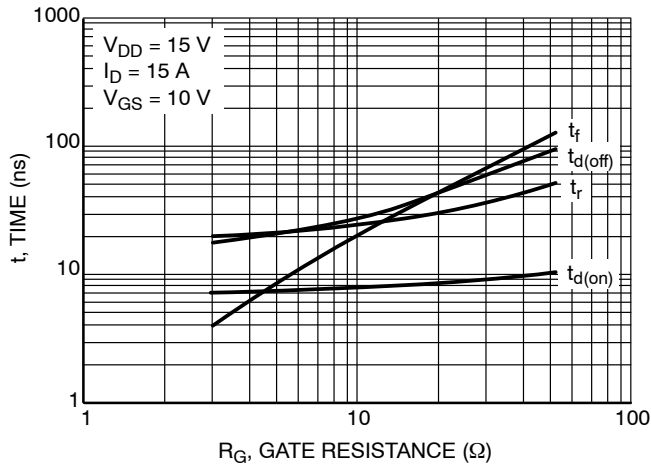

Figure 9. Resistive Switching Time Variation vs. Gate Resistance

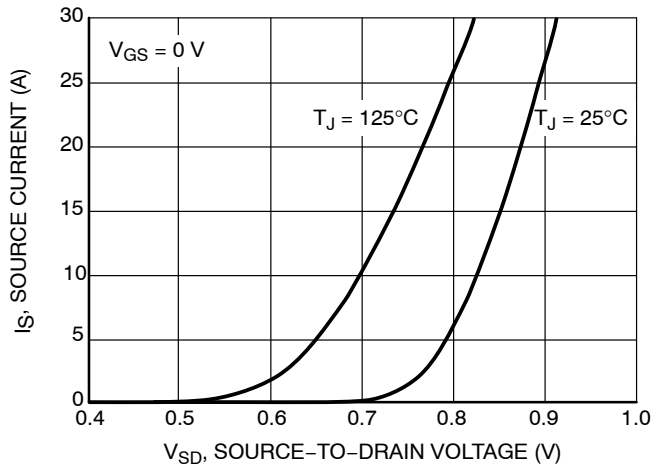

Figure 10. Diode Forward Voltage vs. Current

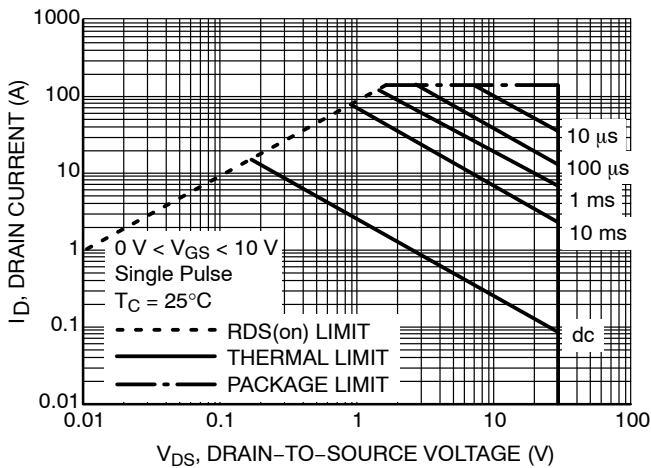

Figure 11. Maximum Rated Forward Biased Safe Operating Area

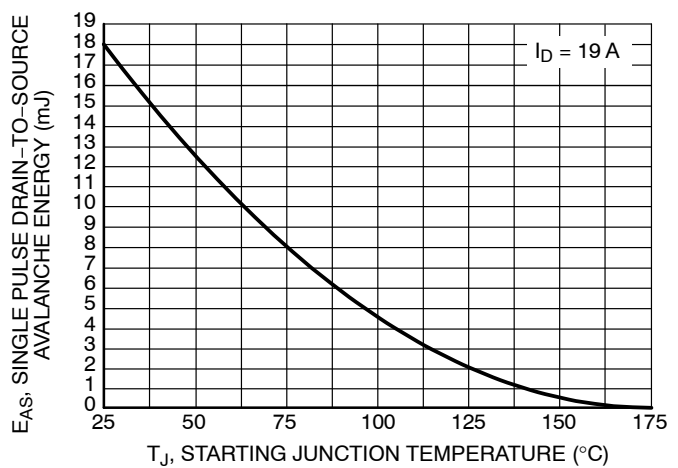

Figure 12. Maximum Avalanche Energy vs. Starting Junction Temperature

# MECHANICAL CASE OUTLINE

## PACKAGE DIMENSIONS

ON Semiconductor®



### IPAK CASE 369D-01 ISSUE C

DATE 15 DEC 2010

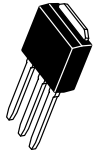

SCALE 1:1

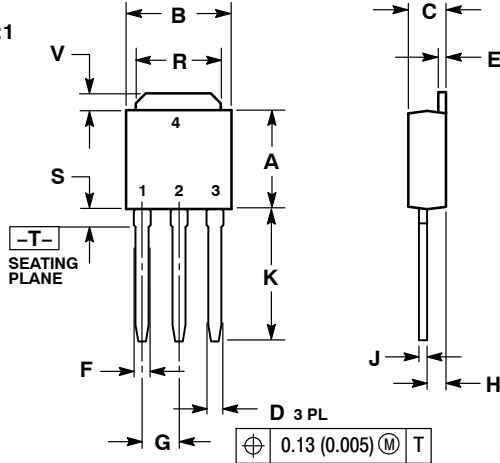

- NOTES:
1. DIMENSIONING AND TOLERANCING PER ANSI Y14.5M, 1982.
  2. CONTROLLING DIMENSION: INCH.

DIM	INCHES		MILLIMETERS	
	MIN	MAX	MIN	MAX
A	0.235	0.245	5.97	6.35
B	0.250	0.265	6.35	6.73
C	0.086	0.094	2.19	2.38
D	0.027	0.035	0.69	0.88
E	0.018	0.023	0.46	0.58
F	0.037	0.045	0.94	1.14
G	0.090	BSC	2.29	BSC
H	0.034	0.040	0.87	1.01
J	0.018	0.023	0.46	0.58
K	0.350	0.380	8.89	9.65
R	0.180	0.215	4.45	5.45
S	0.025	0.040	0.63	1.01
V	0.035	0.050	0.89	1.27
Z	0.155	---	3.93	---

- |  |   |  |  |
|--|---|--|--|
| <p>STYLE 1:<br/>PIN 1. BASE<br/>2. COLLECTOR<br/>3. EMITTER<br/>4. COLLECTOR</p> | <p>STYLE 2:<br/>PIN 1. GATE<br/>2. DRAIN<br/>3. SOURCE<br/>4. DRAIN</p> | <p>STYLE 3:<br/>PIN 1. ANODE<br/>2. CATHODE<br/>3. ANODE<br/>4. CATHODE</p>      | <p>STYLE 4:<br/>PIN 1. CATHODE<br/>2. ANODE<br/>3. GATE<br/>4. ANODE</p> |
| <p>STYLE 5:<br/>PIN 1. GATE<br/>2. ANODE<br/>3. CATHODE<br/>4. ANODE</p>         | <p>STYLE 6:<br/>PIN 1. MT1<br/>2. MT2<br/>3. GATE<br/>4. MT2</p>        | <p>STYLE 7:<br/>PIN 1. GATE<br/>2. COLLECTOR<br/>3. EMITTER<br/>4. COLLECTOR</p> |  |

### MARKING DIAGRAMS

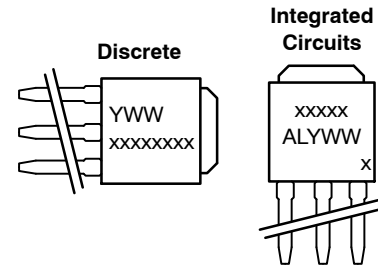

- xxxxxxxx = Device Code  
A = Assembly Location  
IL = Wafer Lot  
Y = Year  
WW = Work Week

<b>DOCUMENT NUMBER:</b>	<b>98AON10528D</b>	Electronic versions are uncontrolled except when accessed directly from the Document Repository. Printed versions are uncontrolled except when stamped "CONTROLLED COPY" in red.
<b>DESCRIPTION:</b>	<b>IPAK (DPAK INSERTION MOUNT)</b>	<b>PAGE 1 OF 1</b>

ON Semiconductor and are trademarks of Semiconductor Components Industries, LLC dba ON Semiconductor or its subsidiaries in the United States and/or other countries. ON Semiconductor reserves the right to make changes without further notice to any products herein. ON Semiconductor makes no warranty, representation or guarantee regarding the suitability of its products for any particular purpose, nor does ON Semiconductor assume any liability arising out of the application or use of any product or circuit, and specifically disclaims any and all liability, including without limitation special, consequential or incidental damages. ON Semiconductor does not convey any license under its patent rights nor the rights of others.

# MECHANICAL CASE OUTLINE

## PACKAGE DIMENSIONS

ON Semiconductor®

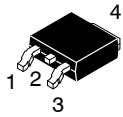

SCALE 1:1

### DPAK (SINGLE GAUGE)

#### CASE 369AA-01

#### ISSUE B

DATE 03 JUN 2010

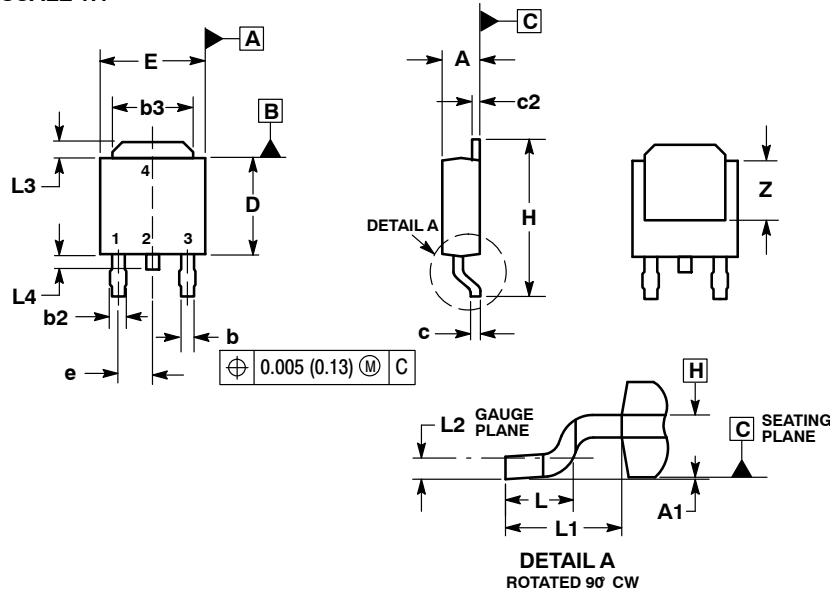

NOTES:

- DIMENSIONING AND TOLERANCING PER ASME Y14.5M, 1994.
- CONTROLLING DIMENSION: INCHES.
- THERMAL PAD CONTOUR OPTIONAL WITHIN DIMENSIONS b3, L3 and Z.
- DIMENSIONS D AND E DO NOT INCLUDE MOLD FLASH, PROTRUSIONS, OR BURRS. MOLD FLASH, PROTRUSIONS, OR GATE BURRS SHALL NOT EXCEED 0.006 INCHES PER SIDE.
- DIMENSIONS D AND E ARE DETERMINED AT THE OUTERMOST EXTREMES OF THE PLASTIC BODY.
- DATUMS A AND B ARE DETERMINED AT DATUM PLANE H.

DIM	INCHES		MILLIMETERS	
	MIN	MAX	MIN	MAX
A	0.086	0.094	2.18	2.38
A1	0.000	0.005	0.00	0.13
b	0.025	0.035	0.63	0.89
b2	0.030	0.045	0.76	1.14
b3	0.180	0.215	4.57	5.46
c	0.018	0.024	0.46	0.61
c2	0.018	0.024	0.46	0.61
D	0.235	0.245	5.97	6.22
E	0.250	0.265	6.35	6.73
e	0.090 BSC		2.29 BSC	
H	0.370	0.410	9.40	10.41
L	0.055	0.070	1.40	1.78
L1	0.108 REF		2.74 REF	
L2	0.020 BSC		0.51 BSC	
L3	0.035	0.050	0.89	1.27
L4	---	0.040	---	1.01
Z	0.155	---	3.93	---

- |  |   |  |  |
|--|---|--|--|
| <p>STYLE 1:<br/>PIN 1. BASE<br/>2. COLLECTOR<br/>3. EMITTER<br/>4. COLLECTOR</p> | <p>STYLE 2:<br/>PIN 1. GATE<br/>2. DRAIN<br/>3. SOURCE<br/>4. DRAIN</p> | <p>STYLE 3:<br/>PIN 1. ANODE<br/>2. CATHODE<br/>3. ANODE<br/>4. CATHODE</p>      | <p>STYLE 4:<br/>PIN 1. CATHODE<br/>2. ANODE<br/>3. GATE<br/>4. ANODE</p> |
| <p>STYLE 5:<br/>PIN 1. GATE<br/>2. ANODE<br/>3. CATHODE<br/>4. ANODE</p>         | <p>STYLE 6:<br/>PIN 1. MT1<br/>2. MT2<br/>3. GATE<br/>4. MT2</p>        | <p>STYLE 7:<br/>PIN 1. GATE<br/>2. COLLECTOR<br/>3. EMITTER<br/>4. COLLECTOR</p> |  |

### GENERIC MARKING DIAGRAM\*

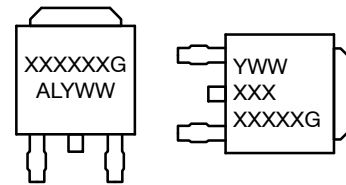

IC Discrete

- XXXXXX = Device Code
- A = Assembly Location
- L = Wafer Lot
- Y = Year
- WW = Work Week
- G = Pb-Free Package

\*This information is generic. Please refer to device data sheet for actual part marking.

### SOLDERING FOOTPRINT\*

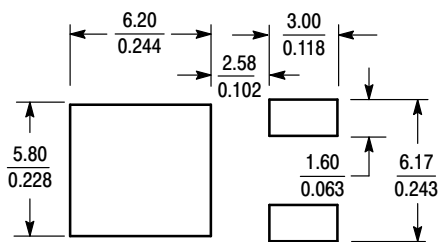

SCALE 3:1 (mm/inches)

\*For additional information on our Pb-Free strategy and soldering details, please download the ON Semiconductor Soldering and Mounting Techniques Reference Manual, SOLDERRM/D.

DOCUMENT NUMBER:	98AON13126D	Electronic versions are uncontrolled except when accessed directly from the Document Repository. Printed versions are uncontrolled except when stamped "CONTROLLED COPY" in red.
DESCRIPTION:	DPAK (SINGLE GAUGE)	PAGE 1 OF 1

ON Semiconductor and ON are trademarks of Semiconductor Components Industries, LLC dba ON Semiconductor or its subsidiaries in the United States and/or other countries. ON Semiconductor reserves the right to make changes without further notice to any products herein. ON Semiconductor makes no warranty, representation or guarantee regarding the suitability of its products for any particular purpose, nor does ON Semiconductor assume any liability arising out of the application or use of any product or circuit, and specifically disclaims any and all liability, including without limitation special, consequential or incidental damages. ON Semiconductor does not convey any license under its patent rights nor the rights of others.

# MECHANICAL CASE OUTLINE

## PACKAGE DIMENSIONS

ON Semiconductor®

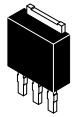

### 3.5 MM IPAK, STRAIGHT LEAD

#### CASE 369AD

#### ISSUE B

DATE 18 APR 2013

SCALE 1:1

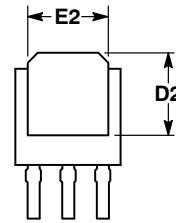
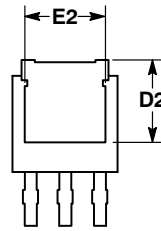
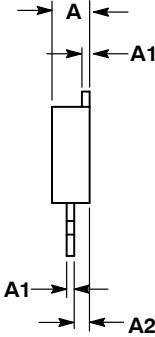
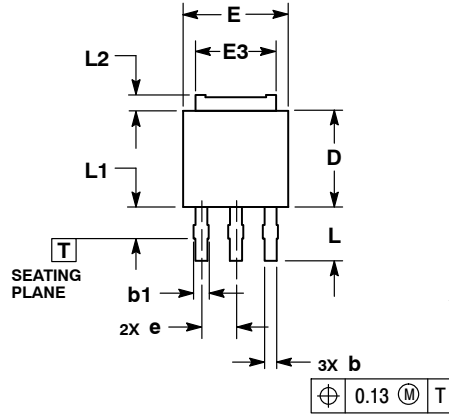

OPTIONAL CONSTRUCTION

NOTES:

- 1.. DIMENSIONING AND TOLERANCING PER ASME Y14.5M, 1994.
- 2.. CONTROLLING DIMENSION: MILLIMETERS.
3. DIMENSION b APPLIES TO PLATED TERMINAL AND IS MEASURED BETWEEN 0.15 AND 0.30mm FROM TERMINAL TIP.
4. DIMENSIONS D AND E DO NOT INCLUDE MOLD GATE OR MOLD FLASH.

DIM	MILLIMETERS	
	MIN	MAX
A	2.19	2.38
A1	0.46	0.60
A2	0.87	1.10
b	0.69	0.89
b1	0.77	1.10
D	5.97	6.22
D2	4.80	---
E	6.35	6.73
E2	4.57	5.45
E3	4.45	5.46
e	2.28 BSC	
L	3.40	3.60
L1	---	2.10
L2	0.89	1.27

### GENERIC MARKING DIAGRAMS\*

STYLE 1:  
PIN 1. BASE  
2. COLLECTOR  
3. EMITTER  
4. COLLECTOR

STYLE 2:  
PIN 1. GATE  
2. DRAIN  
3. SOURCE  
4. DRAIN

STYLE 3:  
PIN 1. ANODE  
2. CATHODE  
3. ANODE  
4. CATHODE

STYLE 4:  
PIN 1. CATHODE  
2. ANODE  
3. GATE  
4. ANODE

STYLE 5:  
PIN 1. GATE  
2. ANODE  
3. CATHODE  
4. ANODE

STYLE 6:  
PIN 1. MT1  
2. MT2  
3. GATE  
4. MT2

STYLE 7:  
PIN 1. GATE  
2. COLLECTOR  
3. EMITTER  
4. COLLECTOR

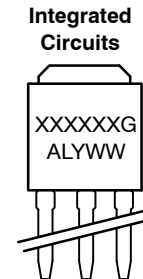
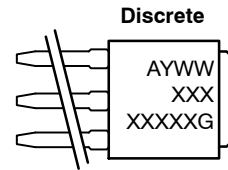

XXXXXX = Device Code  
A = Assembly Location  
L = Wafer Lot  
Y = Year  
WW = Work Week  
G = Pb-Free Package

\*This information is generic. Please refer to device data sheet for actual part marking. Pb-Free indicator, "G" or microdot "▪", may or may not be present.

<b>DOCUMENT NUMBER:</b>	<b>98AON23319D</b>	Electronic versions are uncontrolled except when accessed directly from the Document Repository. Printed versions are uncontrolled except when stamped "CONTROLLED COPY" in red.
<b>DESCRIPTION:</b>	<b>3.5 MM IPAK, STRAIGHT LEAD</b>	<b>PAGE 1 OF 1</b>

ON Semiconductor and are trademarks of Semiconductor Components Industries, LLC dba ON Semiconductor or its subsidiaries in the United States and/or other countries. ON Semiconductor reserves the right to make changes without further notice to any products herein. ON Semiconductor makes no warranty, representation or guarantee regarding the suitability of its products for any particular purpose, nor does ON Semiconductor assume any liability arising out of the application or use of any product or circuit, and specifically disclaims any and all liability, including without limitation special, consequential or incidental damages. ON Semiconductor does not convey any license under its patent rights nor the rights of others.



**onsemi**, **Onsemi**, and other names, marks, and brands are registered and/or common law trademarks of Semiconductor Components Industries, LLC dba "**onsemi**" or its affiliates and/or subsidiaries in the United States and/or other countries. **onsemi** owns the rights to a number of patents, trademarks, copyrights, trade secrets, and other intellectual property. A listing of **onsemi**'s product/patent coverage may be accessed at [www.onsemi.com/site/pdf/Patent-Marking.pdf](http://www.onsemi.com/site/pdf/Patent-Marking.pdf). **onsemi** reserves the right to make changes at any time to any products or information herein, without notice. The information herein is provided "as-is" and **onsemi** makes no warranty, representation or guarantee regarding the accuracy of the information, product features, availability, functionality, or suitability of its products for any particular purpose, nor does **onsemi** assume any liability arising out of the application or use of any product or circuit, and specifically disclaims any and all liability, including without limitation special, consequential or incidental damages. Buyer is responsible for its products and applications using **onsemi** products, including compliance with all laws, regulations and safety requirements or standards, regardless of any support or applications information provided by **onsemi**. "Typical" parameters which may be provided in **onsemi** data sheets and/or specifications can and do vary in different applications and actual performance may vary over time. All operating parameters, including "Typicals" must be validated for each customer application by customer's technical experts. **onsemi** does not convey any license under any of its intellectual property rights nor the rights of others. **onsemi** products are not designed, intended, or authorized for use as a critical component in life support systems or any FDA Class 3 medical devices or medical devices with a same or similar classification in a foreign jurisdiction or any devices intended for implantation in the human body. Should Buyer purchase or use **onsemi** products for any such unintended or unauthorized application, Buyer shall indemnify and hold **onsemi** and its officers, employees, subsidiaries, affiliates, and distributors harmless against all claims, costs, damages, and expenses, and reasonable attorney fees arising out of, directly or indirectly, any claim of personal injury or death associated with such unintended or unauthorized use, even if such claim alleges that **onsemi** was negligent regarding the design or manufacture of the part. **onsemi** is an Equal Opportunity/Affirmative Action Employer. This literature is subject to all applicable copyright laws and is not for resale in any manner.

## PUBLICATION ORDERING INFORMATION

### LITERATURE FULFILLMENT:

Email Requests to: [orderlit@onsemi.com](mailto:orderlit@onsemi.com)

**onsemi Website:** [www.onsemi.com](http://www.onsemi.com)

### TECHNICAL SUPPORT

**North American Technical Support:**

Voice Mail: 1 800-282-9855 Toll Free USA/Canada

Phone: 011 421 33 790 2910

**Europe, Middle East and Africa Technical Support:**

Phone: 00421 33 790 2910

For additional information, please contact your local Sales Representative