

High Isolation Gate Drive Transformers

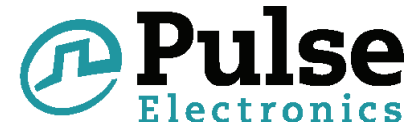

- Ⓜ Rugged design for Industrial Applications
- Ⓜ UL recognized, TUV approved to IEC 60950
- Ⓜ Up to 4250Vrms gate to drive isolation
- Ⓜ IEC 61558, IEC 61010 & IEC 60601 reinforced insulation compliant designs

Electrical Specifications @ 25°C - Operating Temperature -40°C to +125°C

Part Number ^{4,5}	Turns Ratio	ET (V * μsec MAX)	Primary Inductance (1-10) (μH MIN)	Leakage Inductance Gate to Drive (μH MAX)	DCR Drive (1-10) (mΩ ±20%)	DCR Gates (mΩ ±20%)	Hi-Pot	
							Drive-Gate (Vrms)	Gate-Gate (Vrms)
P0584NL	1:1:1	95	450	0.5	80	72	3000	1500
P0585NL	1:1:1:1	95	450	3.0	330	180	3000	1500*
P0584ANL	1:1:1	115	686	0.8	710	710	4250	1500
P0585ANL	1:1:1:1	115	686	4.6	710	710	4250	1500*

- Notes:**
- These gate drive transformers are meant to operate between 50 and 300 kHz with a 12V, 45% bipolar waveform.
 - The peak flux density should remain below 2100 Gauss to ensure that the core does not saturate. Use the following procedure to calculate the peak flux density:
 - Calculate the Volt-μsec product (ET):
 $ET = 10 * (\text{Drive Voltage}) * (\text{Don}) / (\text{Frequency in kHz})$
 - Calculate the operating flux density (B): $B_{PK} (\text{Gauss}) = X * ET / Ff$ where:
 Ff = 1 for unipolar drive applications and 2 for bipolar drive applications,
 X = 40 for -NL, 33 for -ANL
 - The temperature rise of the component is calculated based on the total core loss and copper loss:
 - To calculate total copper loss (W), use the following formula:
 $\text{Copper Loss (W)} = I_{rms}^2 * (\text{DCR_Drive} + (\# \text{ of Gates}) * \text{DCR_Gates})$
 - To calculate total core loss (W), use the following formula:
 $\text{Copper Loss (W)} = 7.5E-5 * (\text{Frequency in kHz})^{1.67} * (X * ET/1000)^{2.532}$
 X = 20 for -NL, 16 for -ANL
 - To calculate temperature rise, use the following formula:
 $\text{Temperature Rise (C)} = 60.18 * (\text{Core Loss(W)} + \text{Copper Loss (W)})^{.833}$
 - 500Vrms Hi-Pot between pins 5 & 6
 - NL versions, which use triple insulated Teflon wire on the drive winding and magnetic wire on the gate windings, are TUV certified.
 ANL versions, which use triple insulated wire on both the drive and gate windings, are compliant with IEC 61558, IEC 61010 & IEC 60601.

High Isolation Gate Drive Transformers

Mechanicals

Schematics

P058xxNL

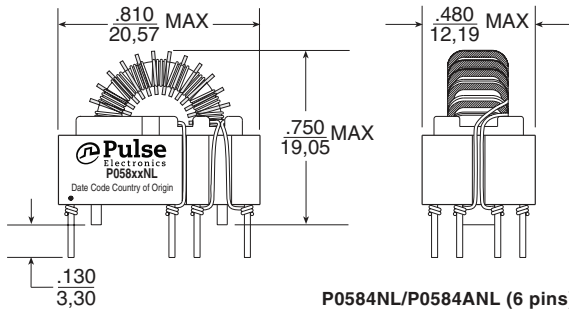

P0584NL/P0584ANL

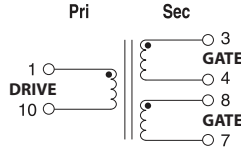

P0585NL/P0585ANL

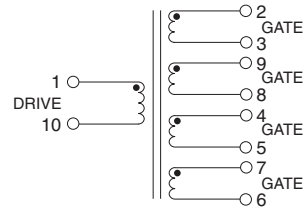

P0584NL/P0584ANL (6 pins)

P0585NL/P0585ANL (10 pins)

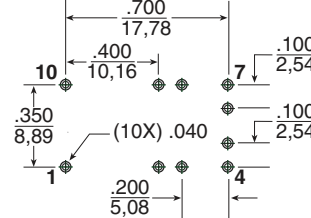
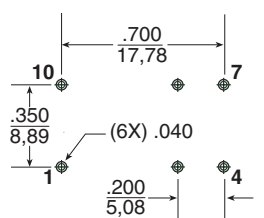
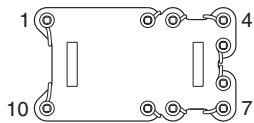

SUGGESTED PCB HOLE PATTERN

Weight5 grams
Tray80/tray

Dimension: $\frac{\text{Inches}}{\text{mm}}$
Unless otherwise specified, all tolerances are $\pm \frac{.010}{0,25}$

For More Information

Pulse Worldwide Headquarters
12220 World Trade Drive
San Diego, CA
92128
U.S.A.

Pulse Europe
Einsteinstrasse 1
D-71083 Herrenberg
Germany

Pulse China Headquarters
B402, Shenzhen Academy of
Aerospace Technology Bldg.
10th Kejian Road
High-Tech Zone
Nanshan District
Shenzhen, PR China
518057
Tel: 86 755 33966678
Fax: 86 755 33966700

Pulse North China
Room 2704/2705
Super Ocean Finance
Ctr.
2067 Yan An Road
West
Shanghai 200336
China
Tel: 86 21 62787060
Fax: 86 2162786973

Pulse South Asia
135 Joo Seng Road
#03-02
PM Industrial Bldg.
Singapore 368363
Tel: 65 6287 8998
Fax: 65 6287 8998

Pulse North Asia
3F, No. 198
Zhongyuan Road
Zhongli City
Taoyuan County 320
Taiwan R. O. C.
Tel: 886 3 4356768
Fax: 886 3 4356823 (Pulse)
Fax: 886 3 4356820 (FRE)

Tel: 858 674 8100
Fax: 858 674 8262

Tel: 49 7032 78060
Fax: 49 7032 7806 135

Performance warranty of products offered on this data sheet is limited to the parameters specified. Data is subject to change without notice. Other brand and product names mentioned herein may be trademarks or registered trademarks of their respective owners. © Copyright, 2015. Pulse Electronics, Inc. All rights reserved.