

VS4 Series Opposed-Mode Sensors



Datasheet

Miniature Self-Contained Sensors



- 10 to 30V dc operation
- Visible red, 660 nm sensing beam
- Up to 1.0 m (39 in) sensing range
- Choose dark or light operate models
- Choose models with NPN (sinking) or PNP (sourcing) output
- 2-wire and 3-wire hookup; output load capacity to 50 mA
- Choice of integral cable or quick-disconnect pigtail



WARNING: Not To Be Used for Personnel Protection

Never use this device as a sensing device for personnel protection. Doing so could lead to serious injury or death. This device does not include the self-checking redundant circuitry necessary to allow its use in personnel safety applications. A sensor failure or malfunction can cause either an energized or de-energized sensor output condition.

Models

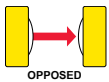

Model Number	Sensing Range	Cable	Supply Voltage	Output Type
VS4EV	1.0 m (39 in)	2 m (6.5 ft) 2 wire	10 to 30V dc	-
VS4EVQ		3-pin pico Pigtail QD		
VS4AN5R		2 m (6.5 ft) 3 wire		NPN/LO
VS4AN5RQ		3-pin pico Pigtail QD		
VS4RN5R		2 m (6.5 ft) 3 wire		NPN/DO
VS4RN5RQ		3-pin pico Pigtail QD		
VS4AP5R		2 m (6.5 ft) 3 wire		PNP/LO
VS4AP5RQ		3-pin pico Pigtail QD		
VS4RP5R		2 m (6.5 ft) 3 wire		PNP/DO
VS4RP5RQ		3-pin pico Pigtail QD		



Wiring Diagrams

Emitters with Cable

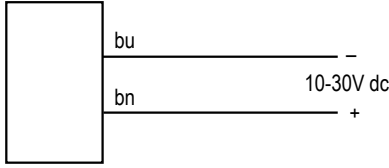

NPN Models with Cable

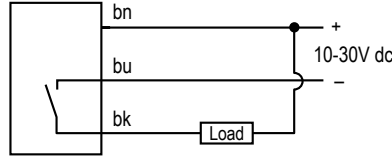

PNP Models with Cable

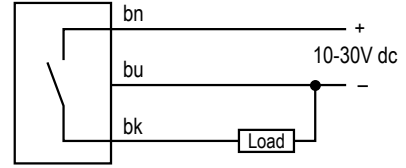

Emitters with Quick-Disconnect

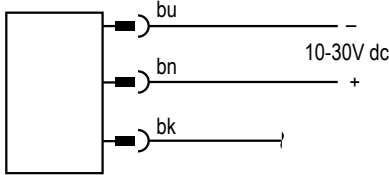

NPN Models with Quick-Disconnect

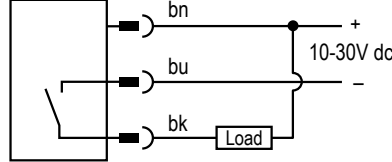

PNP Models with Quick-Disconnect

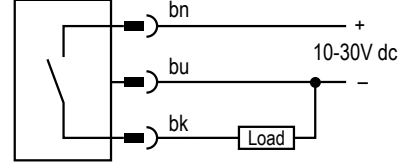

Specifications

Supply Voltage and Current

- 10 to 30V dc (10% maximum ripple)
- Emitter: 25 mA
- Receiver: 25 mA (exclusive of load)

Supply Protection Circuitry

- Protected against reverse polarity and transient voltages

Output Configuration

- SPST solid-state switch
- Choose NPN (current sinking) or PNP (current sourcing), depending on model
- Choose light operate (N.O.) or dark operate (N.C.), depending on model

Output Rating

- 50 mA maximum
- Off-state leakage current: < 1 microamp at 24V dc
- On-state saturation voltage: < 0.25V at 10 mA dc; < 0.5V at 50 mA dc

Output Protection Circuitry

- Protected against false pulse on power-up -and continuous overload or short circuit of outputs
- Overload trip point \geq 100 mA

Output Response Time

- 1 millisecond ON and 0.5 milliseconds OFF
- NOTE: 100 millisecond delay on power-up: output is non-conducting during this time

Repeatability

- 100 microseconds

Environmental Rating

- IEC IP67; NEMA 6

Indicators

- Two LEDs: Green and Yellow
- Green ON steady: power to sensor is ON
- Green flashing: output overload
- Yellow ON steady: light is sensed
- Yellow flashing: marginal excess gain (1 to 1.5x) in light condition

Construction

- Polycarbonate mounting holes and lens
- Low pressure molded thermoplastic housing (UL 94-V0)

Connections

- 2 m (6.5 ft) attached cable: three #28 ga stranded conductors with PE insulation; PVC outer cable jacket; or 3-pin Pico-style pigtail quick-disconnect fitting. QD cables are ordered separately.

Operating Conditions

- Temperature: -20°C to $+55^{\circ}\text{C}$ (-4°F to $+131^{\circ}\text{F}$)
- Humidity: 80% at $+50^{\circ}\text{C}$ maximum relative humidity (non-condensing)

Vibration and Mechanical Shock

- Vibration: All models meet IEC 60068-2-6, IEC 60947-5-2, UL491 Section 40, MIL-STD-202F Method 201A; 10 to 60 Hz, 0.5 mm peak to peak
- Shock: All models meet IEC 60068-2-27, IEC 60947-5-2; 30g peak acceleration, 11 millisecond pulse duration, half-sine wave pulse shape

Application Notes

- M2 stainless steel mounting hardware included. Optional mounting bracket available.

Certifications



Dimensions

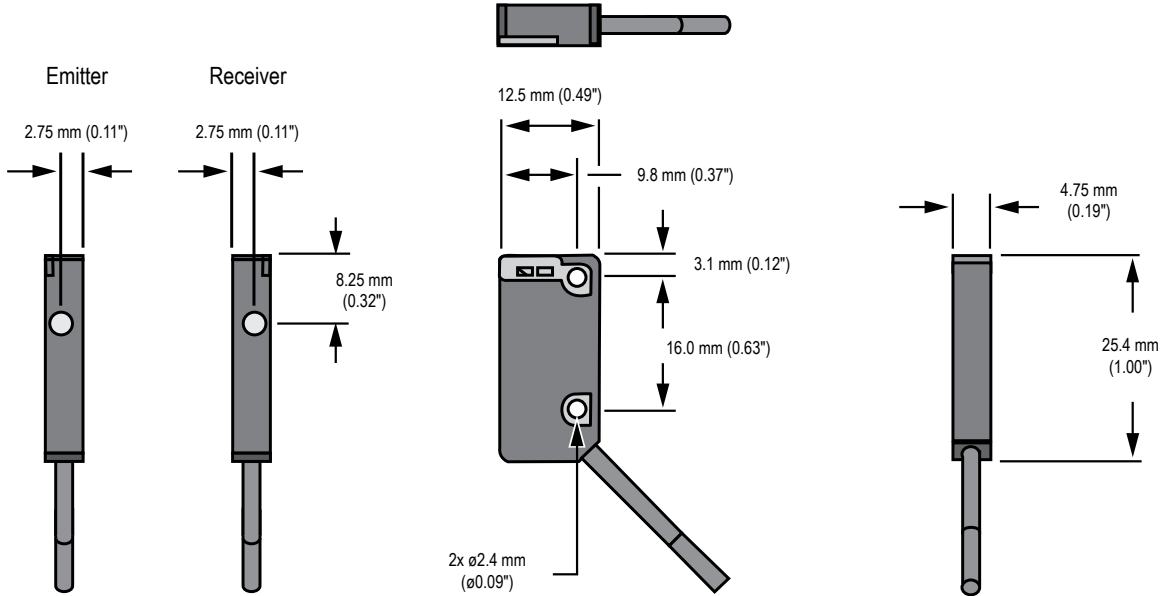

Performance Curves

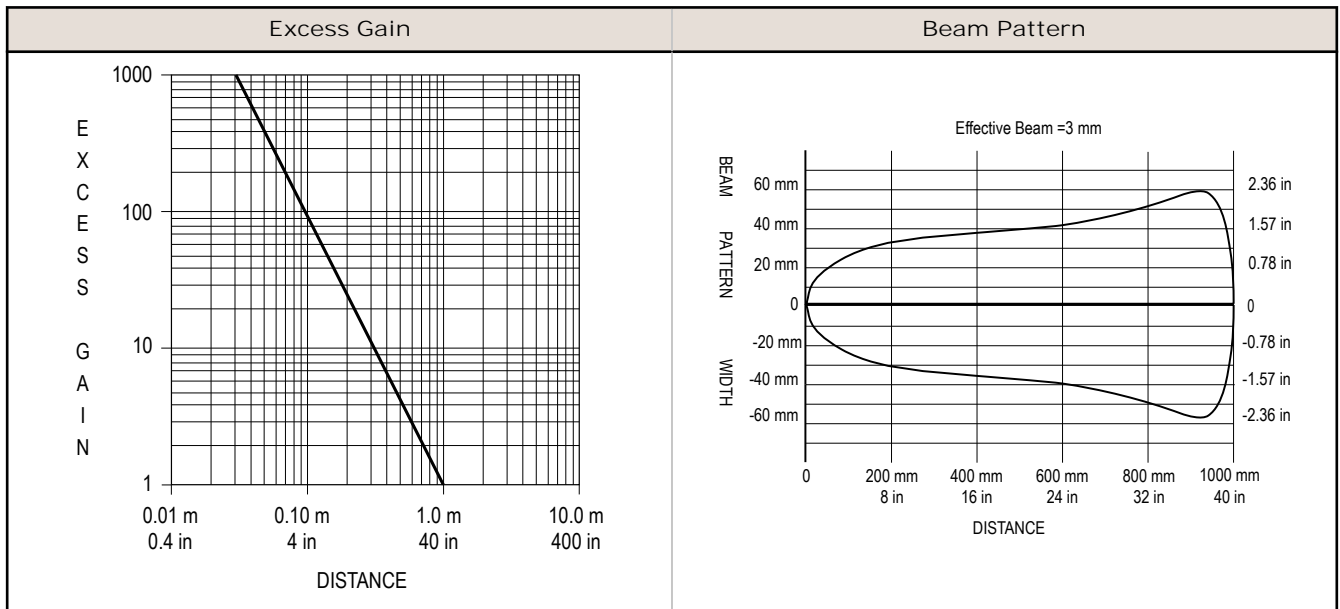

Accessories

Quick-Disconnect Cables

3-Pin Threaded M8/Pico-Style Cordsets				
Model	Length	Style	Dimensions	Pinout (Female)
PKG3M-2	2 m (6.56 ft)	Straight		
PKG3M-5	5 m (16.40 ft)			
PKG3M-7	7 m (22.97 ft)			
PKG3M-9	9 m (29.53 ft)			
PKG3M-10	10 m (32.81 ft)			

Pinout (Female):

- 1 = Brown
- 3 = Blue
- 4 = Black

Apertures

Model	Description	Dimensions
APVS4-0206	<ul style="list-style-type: none"> 2-holed aperture 0.020 in and 0.060 in diameter holes 	
APVS4-0408	<ul style="list-style-type: none"> 2-holed aperture 0.040 in and 0.080 in diameter holes 	

Brackets

SMBVS4SRA

- Right-angle bracket
- 300 series stainless steel

A = 3 x R1.6, B = \varnothing 3.2,
C = R1.2

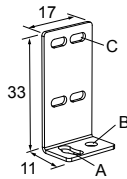

Banner Engineering Corp. Limited Warranty

Banner Engineering Corp. warrants its products to be free from defects in material and workmanship for one year following the date of shipment. Banner Engineering Corp. will repair or replace, free of charge, any product of its manufacture which, at the time it is returned to the factory, is found to have been defective during the warranty period. This warranty does not cover damage or liability for misuse, abuse, or the improper application or installation of the Banner product.

THIS LIMITED WARRANTY IS EXCLUSIVE AND IN LIEU OF ALL OTHER WARRANTIES WHETHER EXPRESS OR IMPLIED (INCLUDING, WITHOUT LIMITATION, ANY WARRANTY OF MERCHANTABILITY OR FITNESS FOR A PARTICULAR PURPOSE), AND WHETHER ARISING UNDER COURSE OF PERFORMANCE, COURSE OF DEALING OR TRADE USAGE.

This Warranty is exclusive and limited to repair or, at the discretion of Banner Engineering Corp., replacement. IN NO EVENT SHALL BANNER ENGINEERING CORP. BE LIABLE TO BUYER OR ANY OTHER PERSON OR ENTITY FOR ANY EXTRA COSTS, EXPENSES, LOSSES, LOSS OF PROFITS, OR ANY INCIDENTAL, CONSEQUENTIAL OR SPECIAL DAMAGES RESULTING FROM ANY PRODUCT DEFECT OR FROM THE USE OR INABILITY TO USE THE PRODUCT, WHETHER ARISING IN CONTRACT OR WARRANTY, STATUTE, TORT, STRICT LIABILITY, NEGLIGENCE, OR OTHERWISE.

Banner Engineering Corp. reserves the right to change, modify or improve the design of the product without assuming any obligations or liabilities relating to any product previously manufactured by Banner Engineering Corp. Any misuse, abuse, or improper application or installation of this product or use of the product for personal protection applications when the product is identified as not intended for such purposes will void the product warranty. Any modifications to this product without prior express approval by Banner Engineering Corp will void the product warranties. All specifications published in this document are subject to change; Banner reserves the right to modify product specifications or update documentation at any time. Specifications and product information in English supersede that which is provided in any other language. For the most recent version of any documentation, refer to: www.bannerengineering.com.