

VIP-CAB-FLK40/0,14/6,0M

Order No.: 2318842

The figure shows the 50-pos. product version

<http://eshop.phoenixcontact.de/phoenix/treeViewClick.do?UID=2318842>

Assembled round cable with two molded 40-pos. socket strips (1:1 connection). The cable has a 90° punched on connector and a 180° punched on connector, cable length: 6 m

Commercial data

GTIN (EAN)	4046356312325
sales group	I580
Pack	1 pcs.
Customs tariff	85444290
Weight/Piece	0.9131 KG
Catalog page information	Page 259 (IF-2009)

Product notes

WEEE/RoHS-compliant since:
09/17/2007



<http://www.download.phoenixcontact.com>
Please note that the data given here has been taken from the online catalog. For comprehensive information and data, please refer to the user documentation. The General Terms and Conditions of Use apply to Internet downloads.

Technical data

General

Nominal voltage U_N	< 50 V AC
	60 V DC
Max. current carrying capacity per path	1 A
Max. conductor resistance	0.16 Ω /m

Ambient temperature (operation)	-20 °C ... 50 °C
Ambient temperature (storage/transport)	-20 °C ... 70 °C
Number of positions	40
Number of positions, control side	40
Number of connectors, control side	1
Number of positions, module side	40
Number of connectors, modul side	1
Fixed cable length	6 m
Single wire, cross section	0.14 mm ²
AWG	26
Conductor construction: Number of litz wires:	7
Single wire, material	Cu tin-plated
External diameter	9.9 mm
Cable, preassembly	Insulation displacement, IEC 60352-4/DIN EN 60352-4
Shielding	no

Certificates / Approvals



Certification

CUL, UL

Diagrams/Drawings

Dimensioned drawing

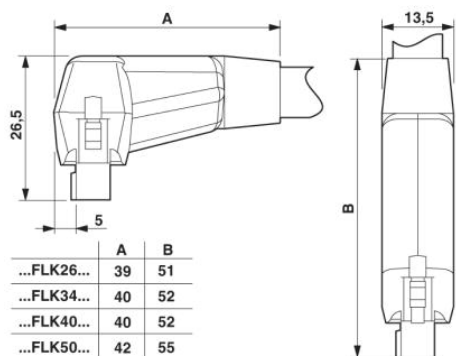

Address

PHOENIX CONTACT Inc., USA
586 Fulling Mill Road
Middletown, PA 17057, USA
Phone (800) 888-7388
Fax (717) 944-1625
<http://www.phoenixcon.com>



© 2010 Phoenix Contact
Technical modifications reserved;