

DATA SHEET

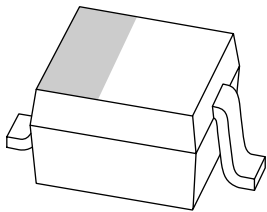

BZX384 series Voltage regulator diodes

Product data sheet
Supersedes data of 2003 Apr 01

2004 Mar 22

Voltage regulator diodes

BZX384 series

FEATURES

- Total power dissipation: max. 300 mW
- Two tolerance series: $\pm 2\%$ and approx. $\pm 5\%$
- Working voltage range: nominal 2.4 to 75 V (E24 range)
- Non-repetitive peak reverse power dissipation: max. 40 W.

APPLICATIONS

- General regulation functions.

DESCRIPTION

Low-power voltage regulator diodes encapsulated in a very small SOD323 (SC-76) plastic SMD package.

The diodes are available in the normalized E24 $\pm 2\%$ (BZX384-B) and approx. $\pm 5\%$ (BZX384-C) tolerance range. The series consists of 37 types with nominal working voltages from 2.4 to 75 V.

PINNING

PIN	DESCRIPTION
1	cathode
2	anode

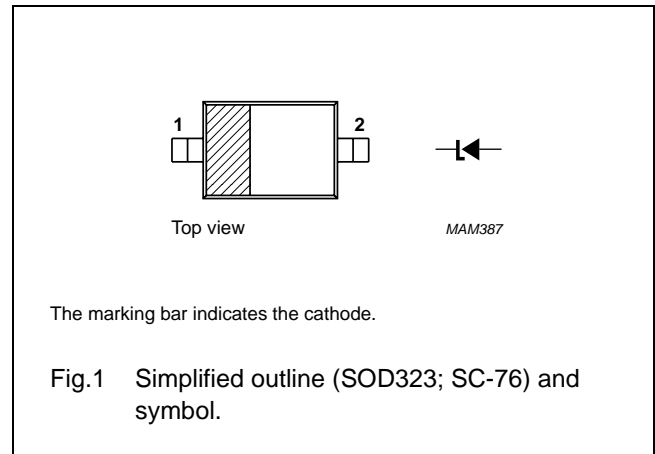

Voltage regulator diodes

BZX384 series

MARKING

TYPE NUMBER	MARKING CODE	TYPE NUMBER	MARKING CODE	TYPE NUMBER	MARKING CODE	TYPE NUMBER	MARKING CODE
Marking codes for BZX384-B2V4 to BZX384-B75							
BZX384-B2V4	K1	BZX384-B6V2	L2	BZX384-B16	M3	BZX384-B43	N3
BZX384-B2V7	K2	BZX384-B6V8	L3	BZX384-B18	M4	BZX384-B47	N4
BZX384-B3V0	K3	BZX384-B7V5	L4	BZX384-B20	M5	BZX384-B51	N5
BZX384-B3V3	K4	BZX384-B8V2	L5	BZX384-B22	M6	BZX384-B56	N6
BZX384-B3V6	K5	BZX384-B9V1	L6	BZX384-B24	M7	BZX384-B62	N7
BZX384-B3V9	K6	BZX384-B10	L7	BZX384-B27	M8	BZX384-B68	N8
BZX384-B4V3	K7	BZX384-B11	L8	BZX384-B30	M9	BZX384-B75	N9
BZX384-B4V7	K8	BZX384-B12	L9	BZX384-B33	N0		
BZX384-B5V1	K9	BZX384-B13	M1	BZX384-B36	N1		
BZX384-B5V6	L1	BZX384-B15	M2	BZX384-B39	N2		
Marking codes for BZX384-C2V4 to BZX384-C75							
BZX384-C2V4	T3	BZX384-C6V2	T1	BZX384-C16	DE	BZX384-C43	DR
BZX384-C2V7	T4	BZX384-C6V8	D7	BZX384-C18	DF	BZX384-C47	DS
BZX384-C3V0	T5	BZX384-C7V5	D8	BZX384-C20	DG	BZX384-C51	DT
BZX384-C3V3	T6	BZX384-C8V2	D9	BZX384-C22	DH	BZX384-C56	DU
BZX384-C3V6	T7	BZX384-C9V1	D0	BZX384-C24	DJ	BZX384-C62	DV
BZX384-C3V9	T8	BZX384-C10	T2	BZX384-C27	DK	BZX384-C68	DW
BZX384-C4V3	T9	BZX384-C11	DA	BZX384-C30	DL	BZX384-C75	DX
BZX384-C4V7	T0	BZX384-C12	DB	BZX384-C33	DM		
BZX384-C5V1	D5	BZX384-C13	DC	BZX384-C36	DN		
BZX384-C5V6	D6	BZX384-C15	DD	BZX384-C39	DP		

ORDERING INFORMATION

TYPE NUMBER	PACKAGE		
	NAME	DESCRIPTION	VERSION
BZX384-B2V4 to BZX384-B75	-	plastic surface mounted package; 2 leads	SOD323
BZX384-C2V4 to BZX384-C75			

Voltage regulator diodes

BZX384 series

LIMITING VALUES

In accordance with the Absolute Maximum Rating System (IEC 60134).

SYMBOL	PARAMETER	CONDITIONS	MIN.	MAX.	UNIT
I_F	continuous forward current		–	250	mA
I_{ZSM}	non-repetitive peak reverse current	$t_p = 100 \mu\text{s}$; square wave; $T_{\text{amb}} = 25 \text{ }^\circ\text{C}$; prior to surge	see Tables 1 and 2		A
P_{ZSM}	non-repetitive peak reverse power dissipation	$t_p = 100 \mu\text{s}$; square wave; $T_{\text{amb}} = 25 \text{ }^\circ\text{C}$; prior to surge	–	40	W
P_{tot}	total power dissipation	$T_{\text{amb}} = 25 \text{ }^\circ\text{C}$; note 1	–	300	mW
T_{stg}	storage temperature		–65	+150	$^\circ\text{C}$
T_j	junction temperature		–65	+150	$^\circ\text{C}$

Note

1. Refer to SOD323 standard mounting conditions.

CHARACTERISTICS**Total BZX384-B and C series** $T_j = 25 \text{ }^\circ\text{C}$ unless otherwise specified.

SYMBOL	PARAMETER	CONDITIONS	MAX.	UNIT
V_F	forward voltage	$I_F = 10 \text{ mA}$; see Fig.3	0.9	V
		$I_F = 100 \text{ mA}$; see Fig.3	1.1	V
I_R	reverse current;			
	BZX384-B/C2V4	$V_R = 1 \text{ V}$	50	μA
	BZX384-B/C2V7	$V_R = 1 \text{ V}$	20	μA
	BZX384-B/C3V0	$V_R = 1 \text{ V}$	10	μA
	BZX384-B/C3V3	$V_R = 1 \text{ V}$	5	μA
	BZX384-B/C3V6	$V_R = 1 \text{ V}$	5	μA
	BZX384-B/C3V9	$V_R = 1 \text{ V}$	3	μA
	BZX384-B/C4V3	$V_R = 1 \text{ V}$	3	μA
	BZX384-B/C4V7	$V_R = 2 \text{ V}$	3	μA
	BZX384-B/C5V1	$V_R = 2 \text{ V}$	2	μA
	BZX384-B/C5V6	$V_R = 2 \text{ V}$	1	μA
	BZX384-B/C6V2	$V_R = 4 \text{ V}$	3	μA
	BZX384-B/C6V8	$V_R = 4 \text{ V}$	2	μA
	BZX384-B/C7V5	$V_R = 5 \text{ V}$	1	μA
	BZX384-B/C8V2	$V_R = 5 \text{ V}$	700	nA
	BZX384-B/C9V1	$V_R = 6 \text{ V}$	500	nA
	BZX384-B/C10	$V_R = 7 \text{ V}$	200	nA
BZX384-B/C11	$V_R = 8 \text{ V}$	100	nA	
BZX384-B/C12	$V_R = 8 \text{ V}$	100	nA	
BZX384-B/C13	$V_R = 8 \text{ V}$	100	nA	
BZX384-B/C15 to 75	$V_R = 0.7V_{Z\text{nom}}$	50	nA	

Voltage regulator diodes

BZX384 series

Table 1 Per type BZX384-B/C2V4 to B/C24 $T_j = 25\text{ °C}$ unless otherwise specified.

BZX- Bxxx Cxxx	WORKING VOLTAGE V_Z (V) at $I_{Ztest} = 5\text{ mA}$				DIFFERENTIAL RESISTANCE r_{dif} (Ω)				TEMPERATURE COEFFICIENT S_Z (mV/K) at $I_{Ztest} = 5\text{ mA}$ (see Figs 4 and 5)			DIODE CAP. C_d (pF) at $f = 1\text{ MHz}$; $V_R = 0\text{ V}$	NON-REPETITIVE PEAK REVERSE CURRENT I_{ZSM} (A) at $t_p = 100\text{ }\mu\text{s}$; $T_{amb} = 25\text{ °C}$
	Tol. $\pm 2\%$ (B)		Tol. $\pm 5\%$ (C)		at $I_{Ztest} = 1\text{ mA}$		at $I_{Ztest} = 5\text{ mA}$		MIN.	TYP.	MAX.	MAX.	MAX.
	MIN.	MAX.	MIN.	MAX.	TYP.	MAX.	TYP.	MAX.					
2V4	2.35	2.45	2.2	2.6	275	600	70	100	-3.5	-1.6	0	450	6.0
2V7	2.65	2.75	2.5	2.9	300	600	75	100	-3.5	-2.0	0	450	6.0
3V0	2.94	3.06	2.8	3.2	325	600	80	95	-3.5	-2.1	0	450	6.0
3V3	3.23	3.37	3.1	3.5	350	600	85	95	-3.5	-2.4	0	450	6.0
3V6	3.53	3.67	3.4	3.8	375	600	85	90	-3.5	-2.4	0	450	6.0
3V9	3.82	3.98	3.7	4.1	400	600	85	90	-3.5	-2.5	0	450	6.0
4V3	4.21	4.39	4.0	4.6	410	600	80	90	-3.5	-2.5	0	450	6.0
4V7	4.61	4.79	4.4	5.0	425	500	50	80	-3.5	-1.4	0.2	300	6.0
5V1	5.00	5.20	4.8	5.4	400	480	40	60	-2.7	-0.8	1.2	300	6.0
5V6	5.49	5.71	5.2	6.0	80	400	15	40	-2.0	1.2	2.5	300	6.0
6V2	6.08	6.32	5.8	6.6	40	150	6	10	0.4	2.3	3.7	200	6.0
6V8	6.66	6.94	6.4	7.2	30	80	6	15	1.2	3.0	4.5	200	6.0
7V5	7.35	7.65	7.0	7.9	30	80	6	15	2.5	4.0	5.3	150	4.0
8V2	8.04	8.36	7.7	8.7	40	80	6	15	3.2	4.6	6.2	150	4.0
9V1	8.92	9.28	8.5	9.6	40	100	6	15	3.8	5.5	7.0	150	3.0
10	9.80	10.20	9.4	10.6	50	150	8	20	4.5	6.4	8.0	90	3.0
11	10.80	11.20	10.4	11.6	50	150	10	20	5.4	7.4	9.0	85	2.5
12	11.80	12.20	11.4	12.7	50	150	10	25	6.0	8.4	10.0	85	2.5
13	12.70	13.30	12.4	14.1	50	170	10	30	7.0	9.4	11.0	80	2.5
15	14.70	15.30	13.8	15.6	50	200	10	30	9.2	11.4	13.0	75	2.0
16	15.70	16.30	15.3	17.1	50	200	10	40	10.4	12.4	14.0	75	1.5
18	17.60	18.40	16.8	19.1	50	225	10	45	12.4	14.4	16.0	70	1.5
20	19.60	20.40	18.8	21.2	60	225	15	55	14.4	16.4	18.0	60	1.5
22	21.60	22.40	20.8	23.3	60	250	20	55	16.4	18.4	20.0	60	1.25
24	23.50	24.50	22.8	25.6	60	250	25	70	18.4	20.4	22.0	55	1.25

Voltage regulator diodes

BZX384 series

Table 2 Per type BZX384-B/C27 to B/C75 $T_j = 25\text{ °C}$ unless otherwise specified.

BZX- Bxxx Cxxx	WORKING VOLTAGE V_Z (V) at $I_{Ztest} = 2\text{ mA}$				DIFFERENTIAL RESISTANCE r_{dif} (Ω)				TEMPERATURE COEFFICIENT S_Z (mV/K) at $I_{Ztest} = 2\text{ mA}$ (see Figs 4 and 5)			DIODE CAP. C_d (pF) at $f = 1\text{ MHz}$; $V_R = 0\text{ V}$	NON-REPETITIVE PEAK REVERSE CURRENT I_{ZSM} (A) at $t_p = 100\text{ }\mu\text{s}$; $T_{amb} = 25\text{ °C}$
	Tol. $\pm 2\%$ (B)		Tol. $\pm 5\%$ (C)		at $I_{Ztest} = 0.5\text{ mA}$		at $I_{Ztest} = 2\text{ mA}$		MIN.	TYP.	MAX.	MAX.	MAX.
	MIN.	MAX.	MIN.	MAX.	TYP.	MAX.	TYP.	MAX.					
27	26.50	27.50	25.1	28.9	65	300	25	80	21.4	23.4	25.3	50	1.0
30	29.40	30.60	28.0	32.0	70	300	30	80	24.4	26.6	29.4	50	1.0
33	32.30	33.70	31.0	35.0	75	325	35	80	27.4	29.7	33.4	45	0.9
36	35.30	36.70	34.0	38.0	80	350	35	90	30.4	33.0	37.4	45	0.8
39	38.20	39.80	37.0	41.0	80	350	40	130	33.4	36.4	41.2	45	0.7
43	42.10	43.90	40.0	46.0	85	375	45	150	37.6	41.2	46.6	40	0.6
47	46.10	47.90	44.0	50.0	85	375	50	170	42.0	46.1	51.8	40	0.5
51	50.00	52.00	48.0	54.0	90	400	60	180	46.6	51.0	57.2	40	0.4
56	54.90	57.10	52.0	60.0	100	425	70	200	52.2	57.0	63.8	40	0.3
62	60.80	63.20	58.0	66.0	120	450	80	215	58.8	64.4	71.6	35	0.3
68	66.60	69.40	64.0	72.0	150	475	90	240	65.6	71.7	79.8	35	0.25
75	73.50	76.50	70.0	79.0	170	500	95	255	73.4	80.2	88.6	35	0.2

Voltage regulator diodes

BZX384 series

THERMAL CHARACTERISTICS

SYMBOL	PARAMETER	CONDITIONS	VALUE	UNIT
$R_{th(j-a)}$	thermal resistance from junction to ambient	note 1	415	K/W
$R_{th(j-s)}$	thermal resistance from junction to soldering point	note 2	110	K/W

Notes

1. Device mounted on an FR4 printed-circuit board.
2. Soldering point of the cathode tab.

Voltage regulator diodes

BZX384 series

GRAPHICAL DATA

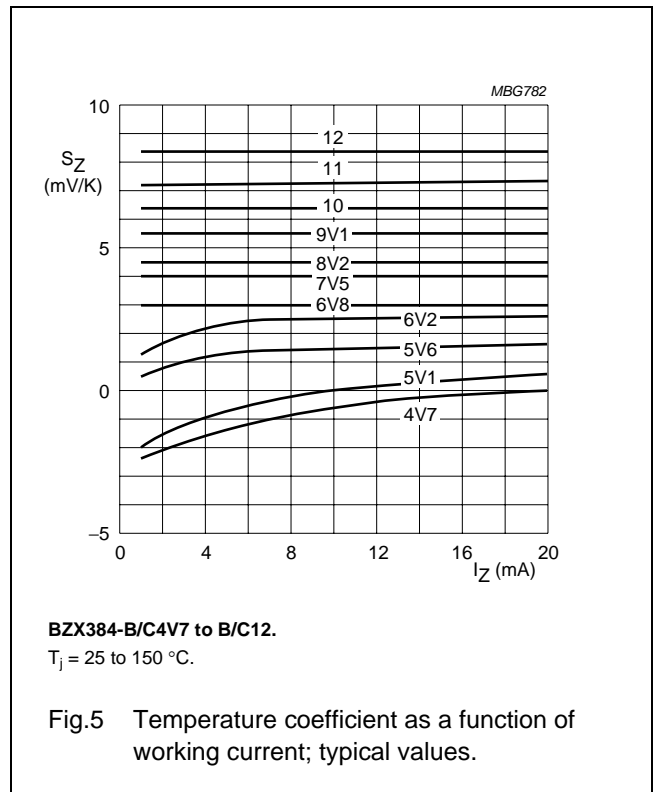
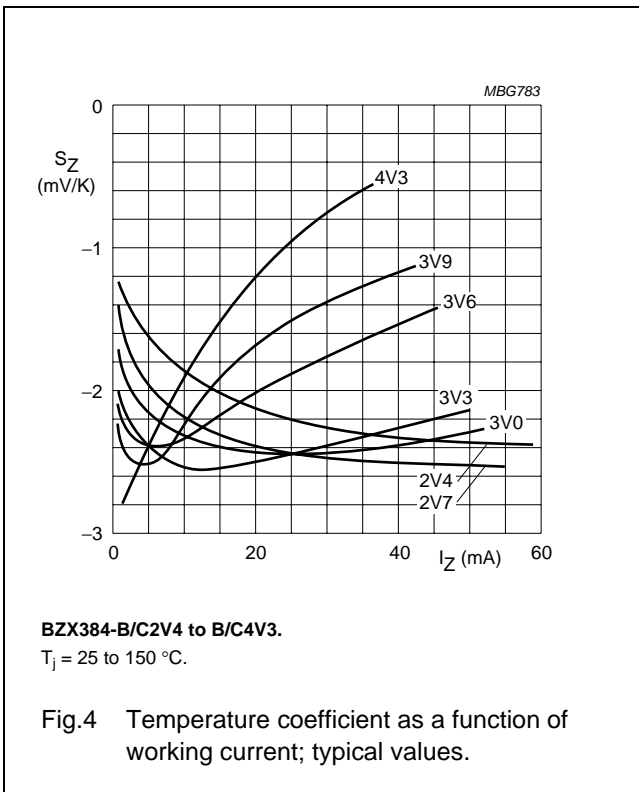
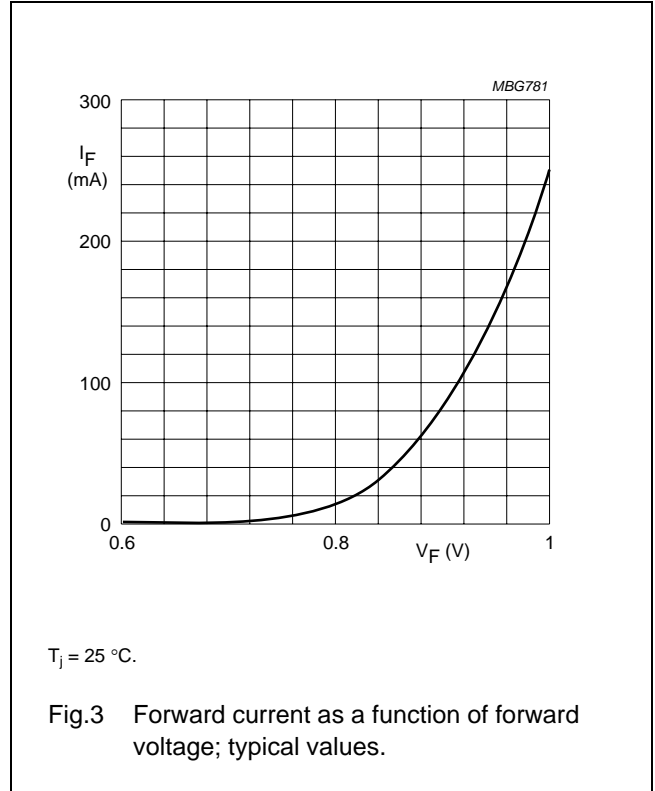
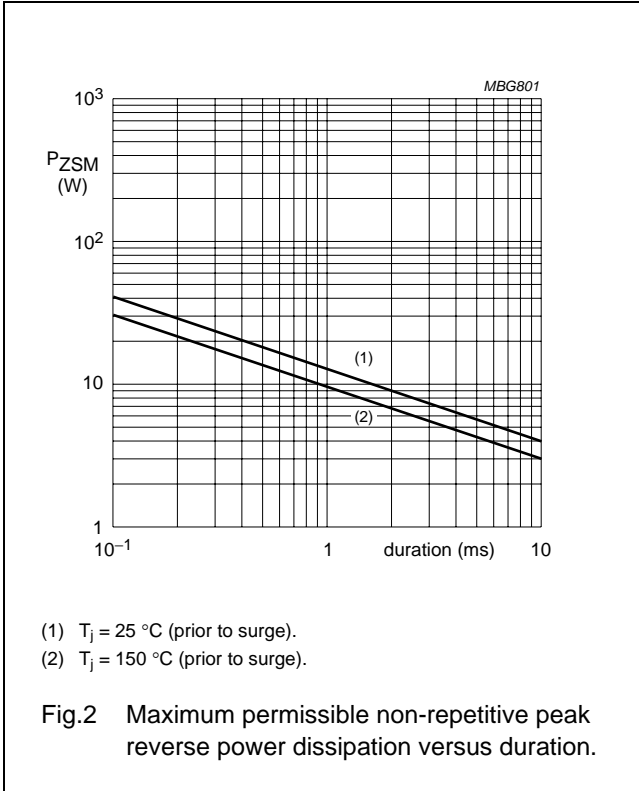

Voltage regulator diodes

BZX384 series

PACKAGE OUTLINE

Plastic surface-mounted package; 2 leads

SOD323

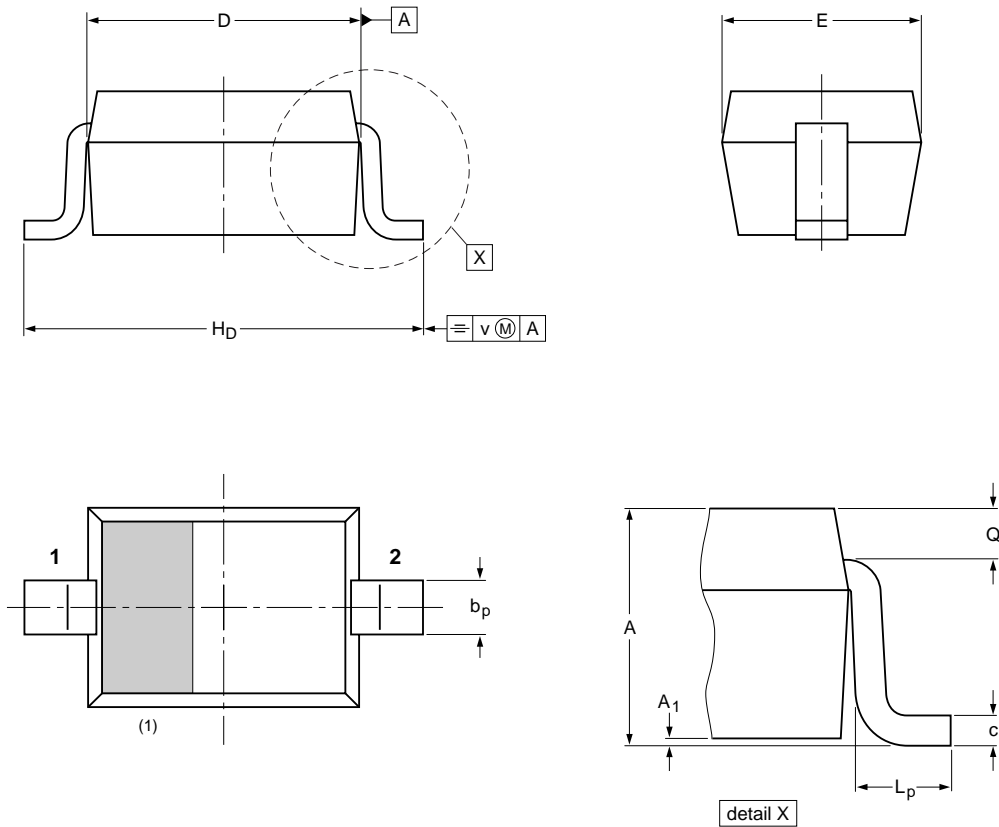

DIMENSIONS (mm are the original dimensions)

UNIT	A	A ₁ max	b _p	c	D	E	H _D	L _p	Q	v
mm	1.1 0.8	0.05	0.40 0.25	0.25 0.10	1.8 1.6	1.35 1.15	2.7 2.3	0.45 0.15	0.25 0.15	0.2

Note

1. The marking bar indicates the cathode

OUTLINE VERSION	REFERENCES			EUROPEAN PROJECTION	ISSUE DATE
	IEC	JEDEC	JEITA		
SOD323			SC-76		-03-12-17- 06-03-16

Voltage regulator diodes

BZX384 series

DATA SHEET STATUS

DOCUMENT STATUS ⁽¹⁾	PRODUCT STATUS ⁽²⁾	DEFINITION
Objective data sheet	Development	This document contains data from the objective specification for product development.
Preliminary data sheet	Qualification	This document contains data from the preliminary specification.
Product data sheet	Production	This document contains the product specification.

Notes

1. Please consult the most recently issued document before initiating or completing a design.
2. The product status of device(s) described in this document may have changed since this document was published and may differ in case of multiple devices. The latest product status information is available on the Internet at URL <http://www.nxp.com>.

DISCLAIMERS

General — Information in this document is believed to be accurate and reliable. However, NXP Semiconductors does not give any representations or warranties, expressed or implied, as to the accuracy or completeness of such information and shall have no liability for the consequences of use of such information.

Right to make changes — NXP Semiconductors reserves the right to make changes to information published in this document, including without limitation specifications and product descriptions, at any time and without notice. This document supersedes and replaces all information supplied prior to the publication hereof.

Suitability for use — NXP Semiconductors products are not designed, authorized or warranted to be suitable for use in medical, military, aircraft, space or life support equipment, nor in applications where failure or malfunction of an NXP Semiconductors product can reasonably be expected to result in personal injury, death or severe property or environmental damage. NXP Semiconductors accepts no liability for inclusion and/or use of NXP Semiconductors products in such equipment or applications and therefore such inclusion and/or use is at the customer's own risk.

Applications — Applications that are described herein for any of these products are for illustrative purposes only. NXP Semiconductors makes no representation or warranty that such applications will be suitable for the specified use without further testing or modification.

Limiting values — Stress above one or more limiting values (as defined in the Absolute Maximum Ratings System of IEC 60134) may cause permanent damage to the device. Limiting values are stress ratings only and operation of the device at these or any other conditions

above those given in the Characteristics sections of this document is not implied. Exposure to limiting values for extended periods may affect device reliability.

Terms and conditions of sale — NXP Semiconductors products are sold subject to the general terms and conditions of commercial sale, as published at <http://www.nxp.com/profile/terms>, including those pertaining to warranty, intellectual property rights infringement and limitation of liability, unless explicitly otherwise agreed to in writing by NXP Semiconductors. In case of any inconsistency or conflict between information in this document and such terms and conditions, the latter will prevail.

No offer to sell or license — Nothing in this document may be interpreted or construed as an offer to sell products that is open for acceptance or the grant, conveyance or implication of any license under any copyrights, patents or other industrial or intellectual property rights.

Export control — This document as well as the item(s) described herein may be subject to export control regulations. Export might require a prior authorization from national authorities.

Quick reference data — The Quick reference data is an extract of the product data given in the Limiting values and Characteristics sections of this document, and as such is not complete, exhaustive or legally binding.

NXP Semiconductors

Customer notification

This data sheet was changed to reflect the new company name NXP Semiconductors, including new legal definitions and disclaimers. No changes were made to the technical content, except for package outline drawings which were updated to the latest version.

Contact information

For additional information please visit: <http://www.nxp.com>

For sales offices addresses send e-mail to: salesaddresses@nxp.com

© NXP B.V. 2009

All rights are reserved. Reproduction in whole or in part is prohibited without the prior written consent of the copyright owner.

The information presented in this document does not form part of any quotation or contract, is believed to be accurate and reliable and may be changed without notice. No liability will be accepted by the publisher for any consequence of its use. Publication thereof does not convey nor imply any license under patent- or other industrial or intellectual property rights.

Printed in The Netherlands

R76/02/pp11

Date of release: 2004 Mar 22

Document order number: 9397 750 12616

