

0805 Multilayer Ferrite Chip Bead

ACML-0805



RoHS/RoHS II compliant



2.00 x 1.25 x 0.85mm

FEATURES:

- Multilayer monolithic construction yields high reliability
- Nickel barrier terminations provide excellent solder heat resistance
- Suitable for flow and RoHS reflow soldering

APPLICATIONS:

- Video equipment, audio equipment
- Automotive electrical equipment
- Communication equipment
- OA equipment and other

ELECTRICAL SPECIFICATIONS:

PARAMETERS

Operating temperature: -55°C to + 125°C

Storage temperature : -55°C to + 125°C

Part Number	Impedance	Frequency	DC resistance	Rated Current
Units	$\Omega \pm 25\%$	MHz	Ω max	mA max
Symbol	Z	F	R _{DC}	I _R
ACML-0805-070	7	100	0.05	2200
ACML-0805-110	11	100	0.05	2000
ACML-0805-170	17	100	0.05	2000
ACML-0805-190	19	100	0.05	2000
ACML-0805-260	26	100	0.05	1500
ACML-0805-310	31	100	0.05	1500
ACML-0805-360	36	100	0.05	1500
ACML-0805-500	50	100	0.05	1000
ACML-0805-600	60	100	0.05	1000
ACML-0805-700	70	100	0.08	1000
ACML-0805-800	80	100	0.10	1000
ACML-0805-101	100	100	0.12	1000
ACML-0805-121	120	100	0.15	800
ACML-0805-151	150	100	0.15	800
ACML-0805-181	180	100	0.20	600
ACML-0805-221	220	100	0.20	600
ACML-0805-301	300	100	0.25	500
ACML-0805-501	500	100	0.30	500
ACML-0805-601	600	100	0.35	500
ACML-0805-751	750	100	0.35	300
ACML-0805-102	1000	100	0.45	300
ACML-0805-122	1200	50	0.50	200
ACML-0805-152	1500	50	0.65	200
ACML-0805-202	2000	50	0.80	200

Test Conditions and Equipments

I_R: Rated current applied when the chip surface temperature rise just 20°C against chip surface temperature.

Electric power supplier, Electric current meter, Thermometer.

Z: Impedance Analyzer HP4291 or equivalent, 50mV.

DCR: LCR Meter HP4263A or equivalent

ABRACON IS
ISO9001:2008
CERTIFIED



Visit www.abracon.com for Terms & Conditions of Sale **Revised: 04.09.14**
30332 Esperanza, Rancho Santa Margarita, California 92688
tel 949-546-8000 | fax 949-546-8001 | www.abracon.com

0805 Multilayer Ferrite Chip Bead

ACML-0805



RoHS/RoHS II compliant



2.00 x 1.25 x 0.85mm

OPTIONS AND PART IDENTIFICATION

ACML-0805 - -

Impedance Code

Please refer to the P/N table

Packaging

T: Tape and Reel
(4kpcs / reel)

FREQUENCY CHARACTERISTICS

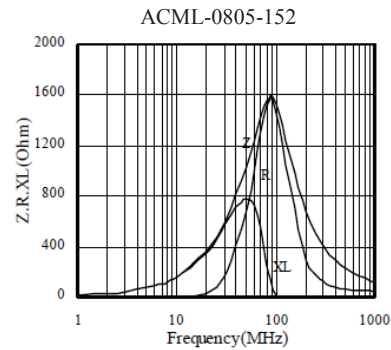
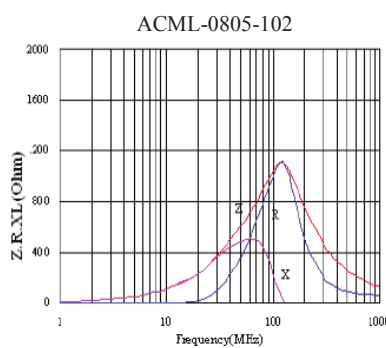
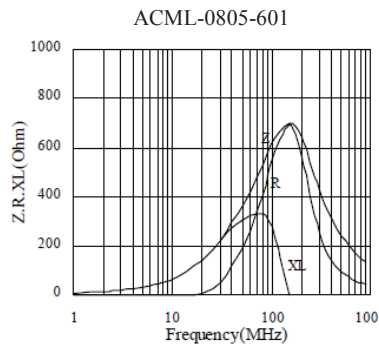
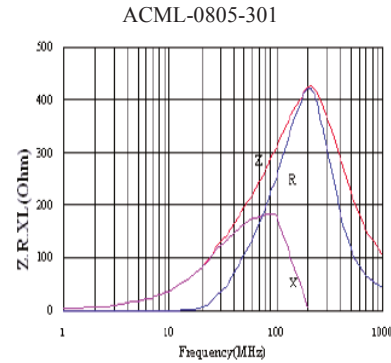
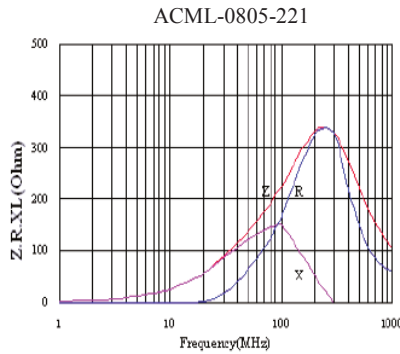
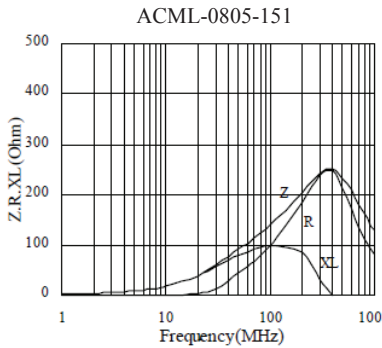
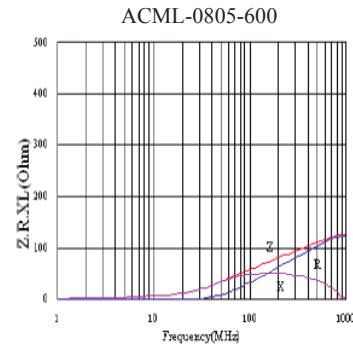
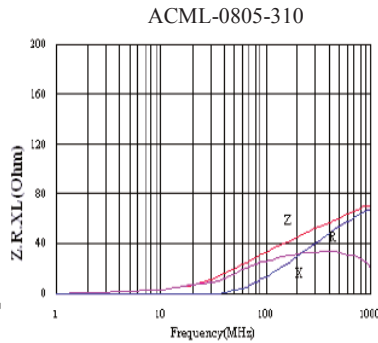
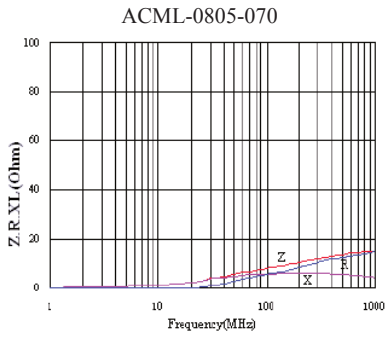

0805 Multilayer Ferrite Chip Bead

ACML-0805



RoHS/RoHS II compliant



2.00 x 1.25 x 0.85mm

MECHANICAL DIMENSIONS

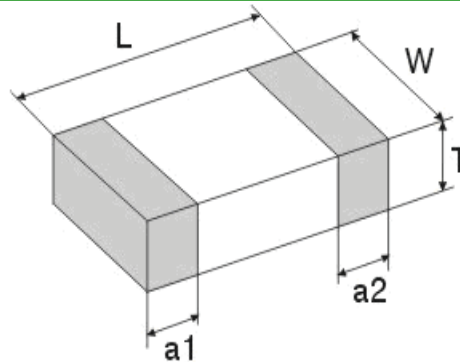

L	W	T	a1, a2
2.00±0.20	1.25±0.20	0.85±0.20	0.50±0.30

Materials

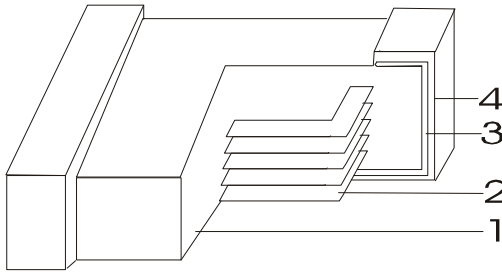

	Part Name	Material
1	Base Material	Ferrite
2	Internal Conductor	Ag
3	Terminal Electrode	Ag
4	Terminal Electrode	Ni-Sn

Dimension: mm

REFLOW PROFILE

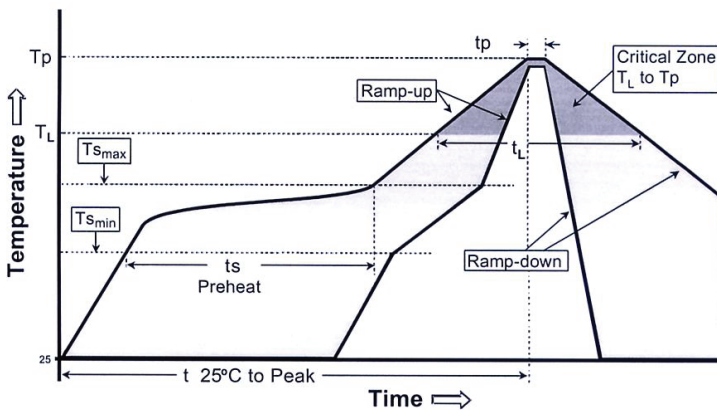

Profile Feature	Lead-Free Assembly
Average Ramp-Up Rate (T _{smax} to T _p)	3°C/second max.
Preheat – Temperature Min (T _{smin}) – Temperature Max (T _{smax}) – Time (t _{smin} to t _{smax})	150 °C 200 °C 60-180 seconds
Time maintained above: – Temperature (T _L) – Time (t _L)	217 °C 60-150 seconds
Peak/Classification Temperature (T _p) Peak/Classification Time (t _p)	260 °C 3-4 seconds
Time within 5 °C of actual Peak Temperature (t _p)	20-40 seconds
Ramp-Down Rate	6°C/second max.
Time 25 °C to Peak Temperature	8 minutes max.

ABRACON IS
ISO9001:2008
CERTIFIED



Visit www.abracon.com for Terms & Conditions of Sale **Revised: 04.09.14**
30332 Esperanza, Rancho Santa Margarita, California 92688
tel 949-546-8000 | fax 949-546-8001 | www.abracon.com

0805 Multilayer Ferrite Chip Bead

ACML-0805



RoHS/RoHS II compliant



2.00 x 1.25 x 0.85mm

TAPE & REEL:

T= tape and reel (4,000 pcs per reel)



A	1.5±0.15
B	2.5±0.2
C	8.0±0.3
D	3.5±0.05
E	1.75±0.1
F	4.0±0.1
G	2.0±0.05
H	4.0±0.1
ΦJ	1.5+0.1/-0
t(max)	1.1±0.05



A	178±2
B	60±2
C	13.0±0.5
D	21.0±0.8
E	2.0±0.5
W	10.0±1.15
t	1.2±0.2
R	1.0±0.25

Dimension: mm

ATTENTION: Abracon Corporation's products are COTS – Commercial-Off-The-Shelf products; suitable for Commercial, Industrial and, where designated, Automotive Applications. Abracon's products are not specifically designed for Military, Aviation, Aerospace, Life-dependant Medical applications or any application requiring high reliability where component failure could result in loss of life and/or property. For applications requiring high reliability and/or presenting an extreme operating environment, written consent and authorization from Abracon Corporation is required. Please contact Abracon Corporation for more information.

ABRACON IS
ISO9001:2008
CERTIFIED



Visit www.abracon.com for Terms & Conditions of Sale **Revised: 04.09.14**
30332 Esperanza, Rancho Santa Margarita, California 92688
tel 949-546-8000 | fax 949-546-8001 | www.abracon.com