

SERIES: SDI65-U | **DESCRIPTION:** AC-DC POWER SUPPLY

FEATURES

- DoE Level VI, CoC Tier 2 efficiency
- 65 W power
- universal input (90~264 Vac)
- compact size
- single regulated output from 12~48 Vdc
- over voltage and short circuit protections
- UL/cUL and PSE safety approvals
- custom designs available
- certified to 60950-1 and 62368-1 standards



| MODEL | output voltage | output current max | output power max | ripple and noise ¹ max | efficiency level ² |
|------------|----------------|--------------------|------------------|-----------------------------------|-------------------------------|
| | (Vdc) | (A) | (W) | (mVp-p) | |
| SDI65-12-U | 12 | 5 | 60 | 120 | VI |
| SDI65-15-U | 15 | 4.34 | 65 | 150 | VI |
| SDI65-18-U | 18 | 3.62 | 65 | 180 | VI |
| SDI65-19-U | 19 | 3.43 | 65 | 190 | VI |
| SDI65-24-U | 24 | 2.71 | 65 | 240 | VI |
| SDI65-48-U | 48 | 1.36 | 65 | 480 | VI |

Notes: 1. At full load, nominal input, 20 MHz bandwidth oscilloscope, each output terminated with 0.1 µF multilayer ceramic and 10 µF low ESR electrolytic capacitors.
2. CoC Tier 2 compliant

PART NUMBER KEY

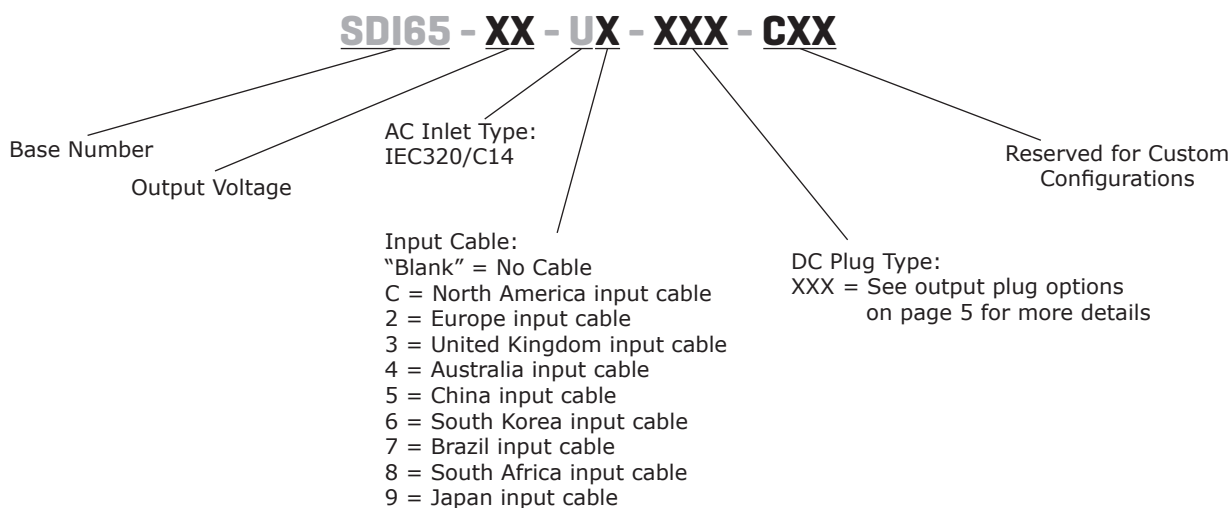

INPUT

| parameter | conditions/description | min | typ | max | units |
|---------------------------|---|-----|-----|-------|-------|
| voltage | | 90 | | 264 | Vac |
| frequency | | 47 | | 63 | Hz |
| current | | | | 1.4 | A |
| inrush current | at 240 Vac, full load, 25°C, cold start | | | 80 | A |
| leakage current | | | | 3.5 | mA |
| no load power consumption | at 230 Vac | | | 0.150 | W |

OUTPUT

| parameter | conditions/description | min | typ | max | units |
|------------|------------------------|-----|-----|-----|-------|
| regulation | | | ±5 | | % |

PROTECTIONS

| parameter | conditions/description | min | typ | max | units |
|--------------------------|---------------------------------|-----|-----|-----|-------|
| over voltage protection | output latch off | | | 150 | % |
| over current protection | output shut down, auto recovery | | | 180 | % |
| short circuit protection | output shut down, auto recovery | | | | |

SAFETY & COMPLIANCE

| parameter | conditions/description | min | typ | max | units |
|----------------------|---|---------|-------|-----|-------|
| isolation voltage | input to output at 10 mA for 1 minute | | 3,000 | | Vac |
| | input to frame ground at 10 ma for 1 minute | | 1,500 | | Vac |
| isolation resistance | input to output at 500 Vdc | 10 | | | MΩ |
| | input to frame ground at 500 Vdc | 10 | | | MΩ |
| safety approvals | UL/cUL (60950-1, 62368-1), PSE, LPS, UKCA | | | | |
| EMI/EMC | FCC Part 15B Class B, CE | | | | |
| MTBF | as per Telcordia SR-332, 25°C | 300,000 | | | hours |
| RoHS | yes | | | | |

ENVIRONMENTAL

| parameter | conditions/description | min | typ | max | units |
|-----------------------|------------------------|-----|-----|-----|-------|
| operating temperature | | 0 | | 40 | °C |
| storage temperature | | -20 | | 80 | °C |
| operating humidity | non-condensing | 20 | | 80 | % |
| storage humidity | non-condensing | 10 | | 90 | % |

MECHANICAL

| parameter | conditions/description | min | typ | max | units |
|------------|------------------------|-----|-----|-----|-------|
| dimensions | 115 x 53 x 38 | | | | mm |
| inlet plug | IEC320/C14 | | | | |
| weight | without ac cord | | 310 | | g |

MECHANICAL DRAWING

units: mm
tolerance: ±1.0 mm

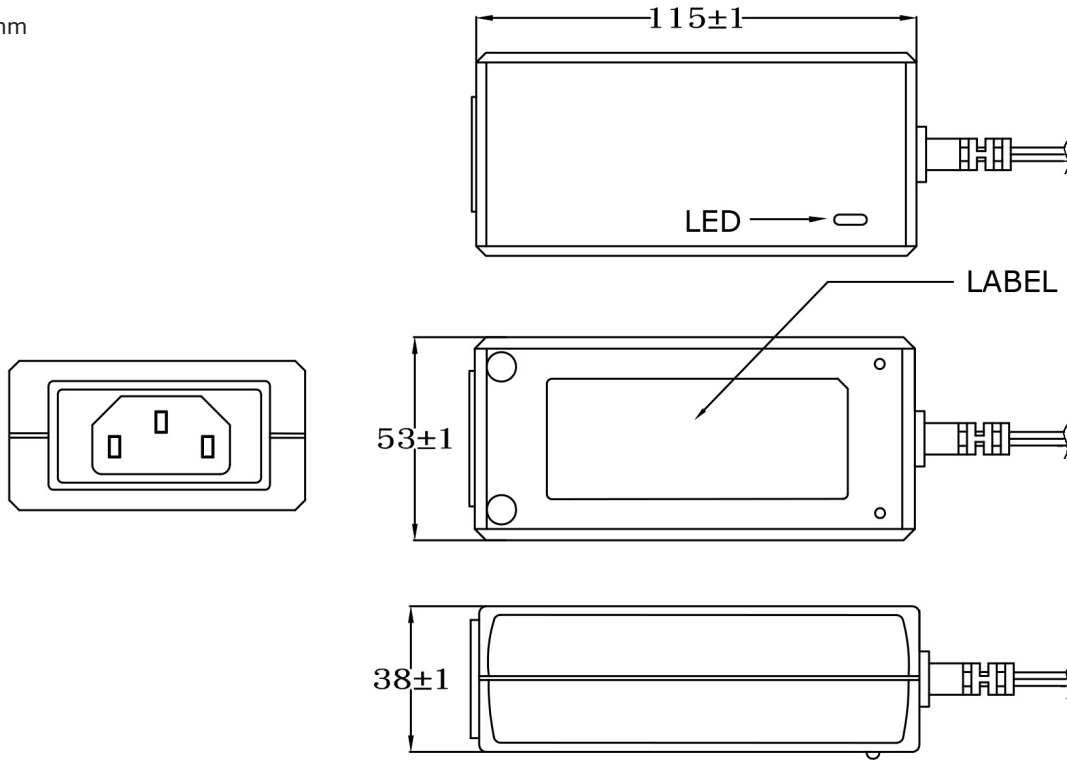

DC CORD

units: mm

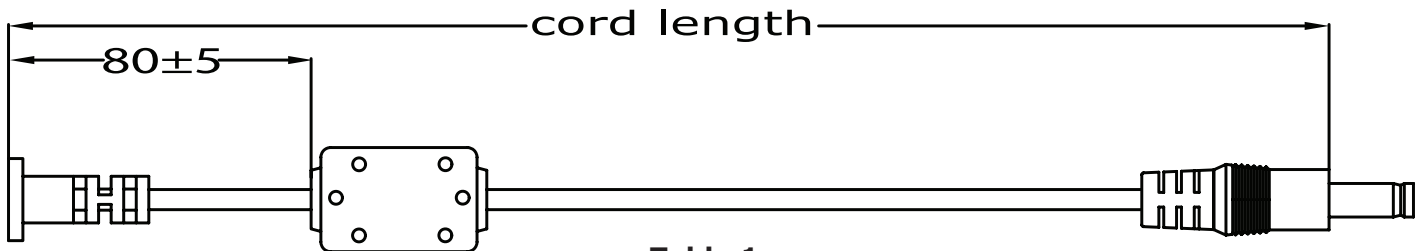
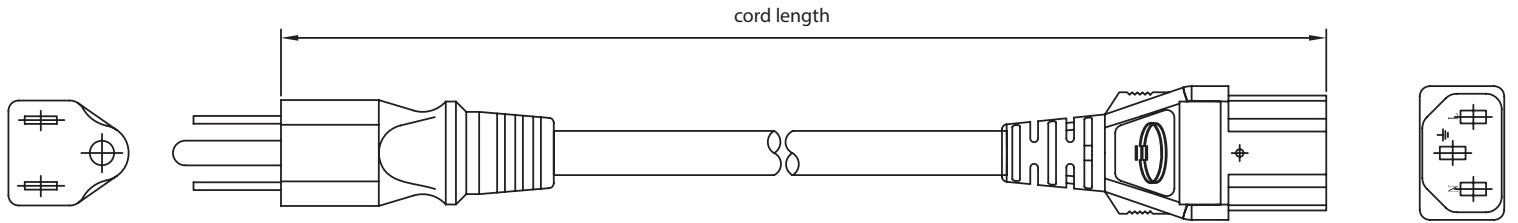

Table 1

| MODEL NO. | CABLE | CORD LENGTH |
|------------|----------------|--------------|
| SDI65-12-U | UL1185, 16 AWG | 1,500 mm ±30 |
| SDI65-15-U | UL1185, 16 AWG | 1,500 mm ±30 |
| SDI65-18-U | UL2468, 18 AWG | 1,500 mm ±30 |
| SDI65-19-U | UL2468, 18 AWG | 1,500 mm ±30 |
| SDI65-24-U | UL2468, 18 AWG | 1,500 mm ±30 |
| SDI65-48-U | UL2468, 20 AWG | 1,500 mm ±30 |

AC CORD

units: mm



NORTH AMERICA

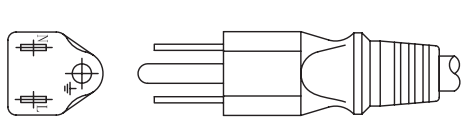

EUROPE

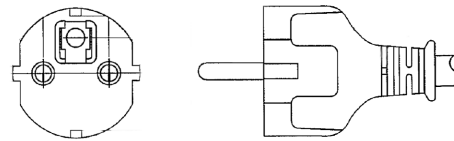

UNITED KINGDOM

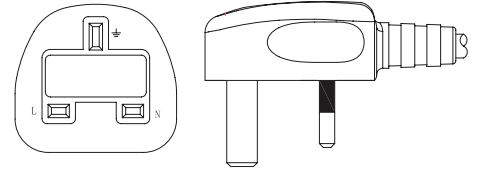

AUSTRALIA

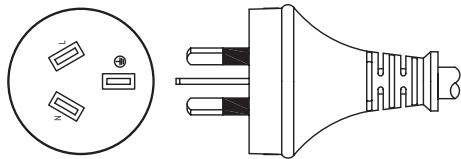

CHINA

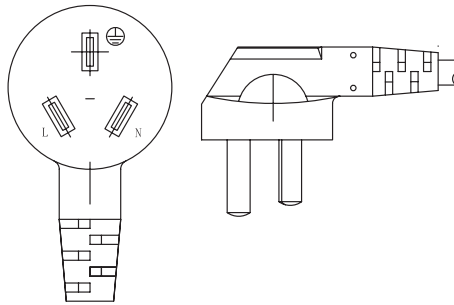

SOUTH KOREA

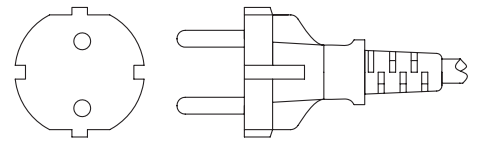

BRAZIL

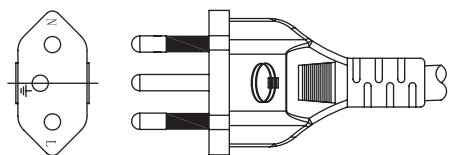

SOUTH AFRICA

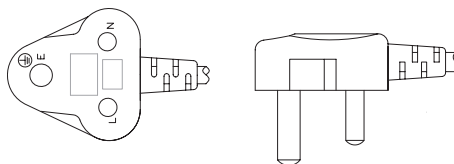

JAPAN

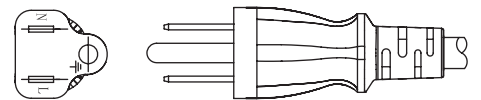

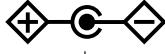

Table 2

| AC INPUT | CORD LENGTH |
|----------------|--------------|
| North America | 1,830 mm ±30 |
| Europe | 1,830 mm ±30 |
| United Kingdom | 1,830 mm ±30 |
| Australia | 1,830 mm ±30 |
| China | 1,830 mm ±30 |
| South Korea | 1,830 mm ±50 |
| Brazil | 1,830 mm ±30 |
| South Africa | 1,830 mm ±50 |
| Japan | 1,830 mm ±30 |

DC PLUG TYPE PART NUMBER KEY

XXX

Plug Polarity:
P = Center Positive

N = Center Negative

Plug Code:
X = Choose a code from the options below

Plug Angle:
"blank" = Straight
R = Right Angle

| Plug Polarity | | Code | | Dimensions (mm) | | | Plug Angle | |
|---------------|-------------|--------|----------------------|-----------------|------|-----|------------|-------|
| Center Pos. | Center Neg. | Option | Type | A | B | C | Straight | Right |
| • | • | 5 | Standard | 5.5 | 2.1 | 9.5 | • | • |
| • | • | 6 | Standard | 5.5 | 2.5 | 9.5 | • | • |
| • | • | 7 | Standard | 3.5 | 1.35 | 9.5 | • | • |
| • | • | 8 | Standard | 3.8 | 1.35 | 9.5 | • | • |
| • | • | 9 | Standard | 3.8 | 1.05 | 9.5 | • | • |
| • | • | 10 | Locking ² | 5.5 | 2.1 | 9.5 | • | N/A |
| • | • | 11 | Locking ² | 5.5 | 2.5 | 9.5 | • | N/A |
| • | • | 12 | EIAJ-1 | 2.35 | 0.7 | 9.5 | • | • |
| • | • | 13 | EIAJ-2 | 4.0 | 1.7 | 9.5 | • | • |
| • | • | 14 | EIAJ-3 | 4.75 | 1.7 | 9.5 | • | • |
| N/A | N/A | ST | Stripped & Tinned | | | N/A | N/A | N/A |

Note: 1. Contact CUI for additional plug options
2. Maximum insertion depth is 10mm

Standard

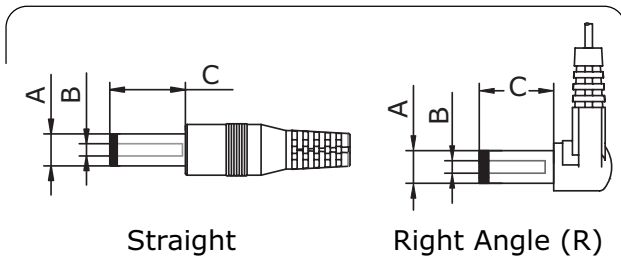

EIAJ

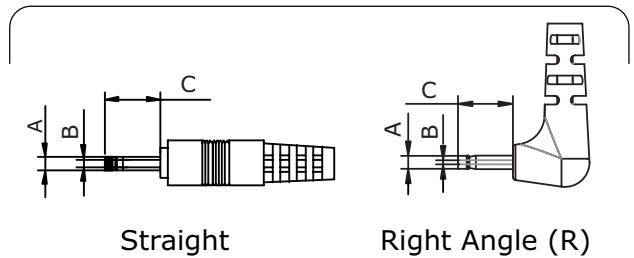

Locking

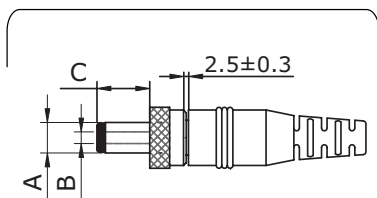

Stripped & Tinned

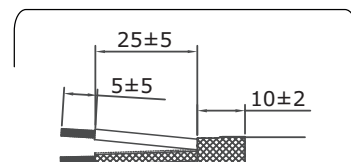

REVISION HISTORY

| rev. | description | date |
|------|-------------------------------|------------|
| 1.0 | initial release | 05/13/2015 |
| 1.01 | updated datasheet | 09/15/2016 |
| 1.02 | added 62368-1 standard | 08/31/2018 |
| 1.03 | removed GS | 12/20/2019 |
| 1.04 | company logo updated | 07/23/2020 |
| 1.05 | UKCA added to specification | 08/11/2021 |
| 1.06 | plug polarity symbols updated | 09/16/2021 |
| 1.07 | mechanical drawing updated | 04/13/2022 |
| 1.08 | dc plugs updated | 05/23/2022 |

The revision history provided is for informational purposes only and is believed to be accurate.



CUI INC

a bel group

Headquarters
20050 SW 112th Ave.
Tualatin, OR 97062
800.275.4899

Fax 503.612.2383
cui.com
techsupport@cui.com

This device complies with part 15 of the FCC Rules. Operation is subject to the following two conditions:

- (1) This device may not cause harmful interference, and
- (2) this device must accept any interference received, including interference that may cause undesired operation.

CUI offers a one (1) year limited warranty. Complete warranty information is listed on our website.

CUI reserves the right to make changes to the product at any time without notice. Information provided by CUI is believed to be accurate and reliable. However, no responsibility is assumed by CUI for its use, nor for any infringements of patents or other rights of third parties which may result from its use.

CUI products are not authorized or warranted for use as critical components in equipment that requires an extremely high level of reliability. A critical component is any component of a life support device or system whose failure to perform can be reasonably expected to cause the failure of the life support device or system, or to affect its safety or effectiveness.