

Evaluates: MAX32675

MAX32675 Evaluation Kit

General Description

The MAX32675 evaluation kit (EV kit) provides a platform for evaluation capabilities of the MAX32675 microcontroller, which is a highly integrated, mixed-signal, ultra-low-power microcontroller designed for industrial and medical sensors. It contains an integrated, low-power HART modem which enables the bidirectional transfer of digital data over a current loop, to/from industrial sensors for configuration and diagnostics.

EV Kit Contents

- MAX32675 EV kit containing a MAX32675 with a preprogrammed demo
- MAX32625PICO debugger w/cables
- One standard A to Micro B USB cable

[Ordering Information](#) appears at end of data sheet.

Features

- HART Compatible Secondary Master with the Ability to Connect to Existing 4-20mA Current Loop and Communicate with HART Enabled Devices
- USB 2.0 Micro B to Serial UART
- Two On-Board, High-Precision Voltage References
- All GPIOs Signals Accessed Through 0.1in Headers
- Access to 4 Analog Inputs Through SMA Connectors Configured as Differential
- Access to 8 Analog Inputs Through 0.1in Headers Configured as Single-Ended
- DAC Output Accessed Through SMA Connector or Test Point
- 10-Pin SWD and Connector
- Board Power Provided by USB Port
- On-Board 1.0V, 1.8V, and 3.3V LDO Regulators
- Individual Power Measurement on all IC Rails Through Jumpers
- Two General-Purpose LEDs and Two General-Purpose Pushbutton Switches

MAX32675 Evaluation Kit

Evaluates: MAX32675

MAX32675 EV Kit Board

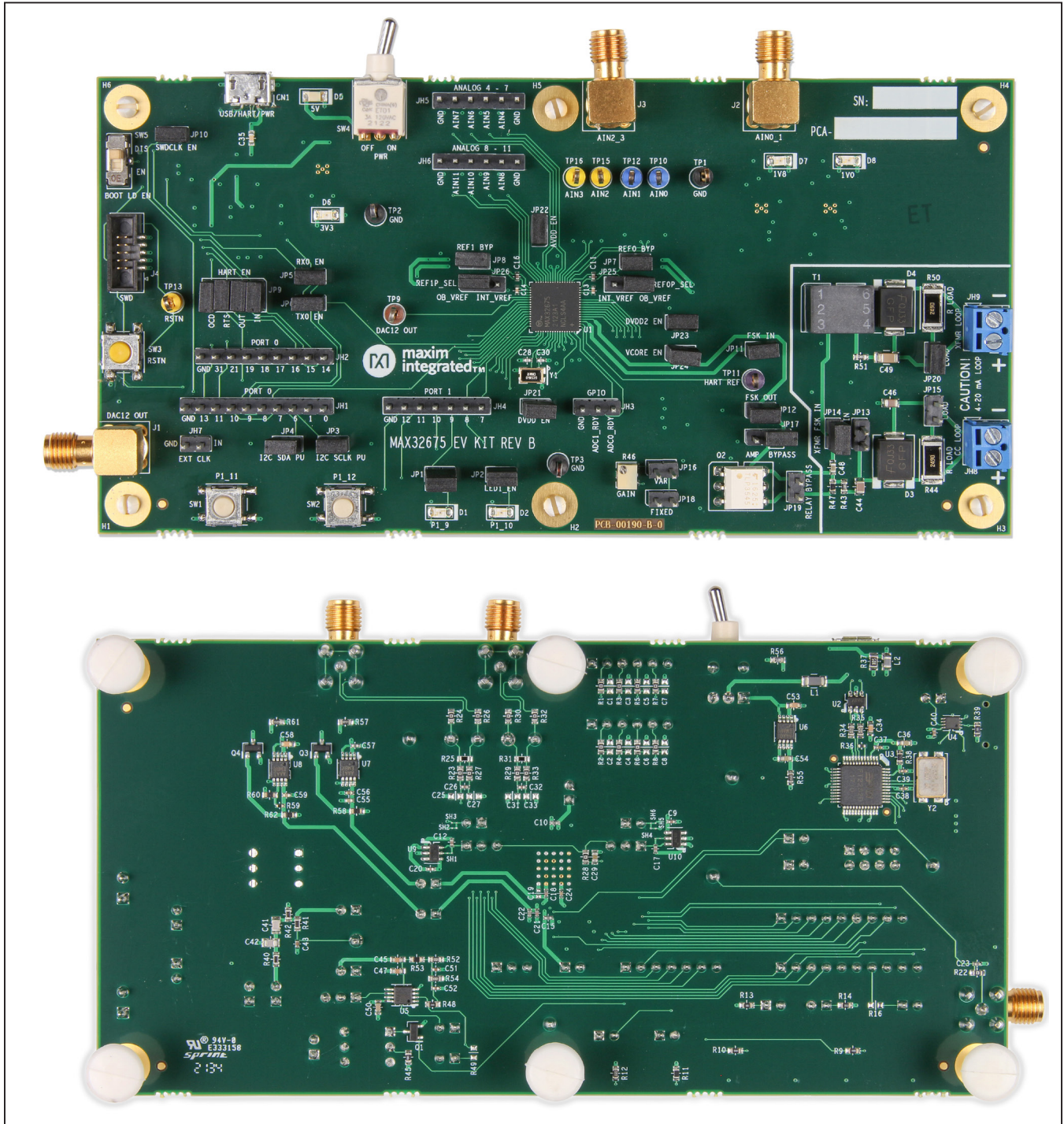

Quick Start

Required Equipment

- MAX32675 EV kit containing a MAX32675 with a preprogrammed demo
- One standard A to Micro B USB cable

Procedure

The EV kit is fully assembled and tested. Use the following steps to verify board operation:

Caution: Do not turn on the power supply until all connections are completed.

- 1) While observing safe ESD practices, carefully remove the MAX32675 EV kit board out of its packaging. Inspect the board to ensure that no damage occurred during shipment. Jumpers/shunts are preinstalled prior to testing and packaging.
- 2) Power up the board by plugging in the provided USB cable to connector CN1. Verify that the 5V blue LED (D5) and the 3V3 (D6), 1V8 (D7), and 1V0 (D8) green LEDs are illuminated.
- 3) The MAX32675 is preprogrammed with a demo program and it flashes green LED (D2) upon successful completion.

Detailed Description of Hardware (or Software)

HART Interface

The HART circuitry acts as a secondary master with the ability to connect to an existing 4mA–20mA current loop and communicates with HART-enabled devices. Connection to a capacitance coupled loop through JH8 and a transformer loop is through JH9. HART communication to the MAX32675 is through the USB connector CN1.

USB-to-HART Interface

The EV kit provides a USB-to-HART bridge chip, FTDI FT231. This bridge eliminates the requirement for a physical RS-232 COM port. Instead, the IC's HART access is through the Micro-USB type-B connector, CN1. Virtual COM port drivers and guides for installing Windows® drivers are available at the FTDI chip website.

Power Supply

The EV kit is powered by +5V that is made available through V_{BUS} on the Micro-USB type-B connector CN1. A blue LED (D5) illuminates when the board is powered.

Green LEDs (D6), (D7), and (D8) illuminate when the 3V3, 1V8, and 1V0 LDOs are powered, respectively.

Current Monitoring

Two pin headers provide convenient current monitoring points for VDDIO EN (JP21), VDDA EN (JP22), VDD18 EN (JP23), and VCORE (JP24).

To accurately achieve the low-power current values, the EV kit needs to be configured such that no outside influence (i.e., pullups, external clock, debugger connector, etc.) causes a current source or sink on that GPIO.

Clocking

The MAX32675 clocking is provided by an external 16MHz crystal (Y1).

Voltage Reference

The differential reference inputs REF0 and REF1 can be sourced by an internal reference (INT_VREF) or a higher precision external reference source, MAX6071. This is selected by jumpers JP25 and JP26.

JTAG Serial Wire Debug (SWD) Support

SWD debug can be accessed through a Arm® Cortex® 10-pin connector (J4). Logic levels are fixed to (3V3). Port UART0 is also accessible at the SWD connector through the provided MAX3625PICO debugger.

Boot Loader

Boot load is activated by boot load enable slide switch SW5.

GPIO and Alternate Function Headers

GPIO and alternate function signals from the MAX32675 can be accessed through 0.1in spaced headers JH1, JH2, JH3, and JH4.

Analog Input Access

Analog inputs (AIN0–AIN3) can be accessed differentially from SMA connectors J2 and J3 or separately from TP10, TP12, TP15, and TP16, respectively.

Analog inputs (AIN4–AIN11) can be accessed through 0.1in spaced headers JH5 and JH6.

I²C Pullups

The I²C port can independently be pulled up to 3V3 through JP3 (I2C_SCL) and JP4 (I2C_SDA).

Reset Pushbutton

The IC can be reset by pushbutton SW3.

Arm and Cortex are registered trademarks of Arm Limited (or its subsidiaries) in the US and/or elsewhere. Windows is a registered trademark and registered service mark of Microsoft Corporation.

Indicator LEDs

General-purpose indicators LED D1 (red) is connected to GPIO P1.9 and LED D2 (green) is connected to GPIO P1.10.

GPIO Pushbutton Switches

The two general-purpose pushbuttons (SW1 and SW2) are connected to GPIO P1.11 and P1.12, respectively. If the pushbutton is pressed, the attached port pin is pulled low.

Table 1. MAX32675 EV Kit Jumper Settings

JUMPER	SIGNAL	SETTINGS	DESCRIPTION
JP1	P1_9	Open	Disconnects red LED D1 from P1_9
		Close*	Connects red LED D1 to P1_9
JP2	P1_10	Open	Disconnects green LED D2 from P1_10
		Close*	Connects green LED D2 to P1_10
JP3	I2C_SCLK	Open	Disconnects 3V3 from I2C_SCLK
		Close	Connects 3V3 to I2C0_SCLK
JP4	I2C_SDA	Open	Disconnects 3V3 to I2C_SDA
		Close	Connects 3V3 to I2C_SDA
JP5	UART0_RX	Open	Disconnects UART0_RX (P0.8) from the SWD connector
		Close*	Connects UART0_RX (P0.8) to the SWD connector
JP6	UART0_TX	Open	Disconnects UART0_TX (P0.9) from the SWD connector
		Close*	Connects UART0_TX (P0.9) to the SWD connector
JP7	REF0N	Open	Disconnects REF0N from ground.
		Close*	Connects REF0N to ground.
JP8	REF1N	Open	Disconnects REF1N from ground.
		Close*	Connects REF1N to ground.
JP9	HART_IN	Open	Disconnects TX of USB - serial bridge from HART_IN (P0.15)
	HART_IN	1-2*	Connects TX of USB - serial bridge to HART_IN (P0.15)
	HART_OUT	Open	Disconnects RX of USB - serial bridge from HART_OUT (P0.14)
	HART_OUT	3-4*	Connects RX of USB - serial bridge to HART_OUT (P0.14)
	HART_RTS	Open	Disconnects RTS of USB - serial bridge from HART_RTS (P1.8)
	HART_RTS	5-6*	Connects TX of USB - serial bridge to HART_RTS (P1.8)
	HART_OCD	Open	Disconnects RTS of USB - serial bridge from HART_OCD (P0.16)
	HART_OCD	7-8*	Connects TX of USB - serial bridge to HART_OCD (P0.16)
JP10	SWD_CLK	Open	Disconnects boot load enable circuit from SWD_CLK (P0.1)
		Close*	Connects boot load enable circuit to SWD_CLK (P0.1)
JP11	FSK_IN	Open	Disconnects FSK_IN from HART analog circuitry
		Close*	Connects FSK_IN to HART analog circuitry
JP12	FSK_OUT	Open	Disconnects FSK_OUT from HART analog circuitry
		Close*	Connects FSK_OUT to HART analog circuitry

Table 1. MAX32675 EV Kit Jumper Settings (continued)

JUMPER	SIGNAL	SETTINGS	DESCRIPTION
JP13	RCV_FSK	Open*	Disconnects RCV_FSK from CC LOOP
		Close	Connects RCV_FSK to CC LOOP
JP14	RCV_FSK	Open	Disconnects RCV_FSK from XFMR LOOP
		Close*	Connects RCV_FSK to XFMR LOOP
JP15	RLOAD	Open*	Disconnects 249Ω resistor shunt from CC LOOP
		Close	Connects 249Ω resistor shunt to CC LOOP
JP16	N/A	N/A	N/A
		N/A	N/A
JP17	N/A	N/A	N/A
		N/A	N/A
JP18	N/A	N/A	N/A
		N/A	N/A
JP19	HART_RTS	Open*	Enables HART_RTS optical transceiver
		Close	Bypasses HART_RTS optical transceiver
JP20	RLOAD	Open	Disconnects 249Ω resistor shunt from XFMR LOOP
		Close*	Connects 249Ω resistor shunt to XFMR LOOP
JP21	VDDIO	Open	Disconnects power from VDDIO
		Close*	Connects power to VDDIO
JP22	VDDA	Open	Disconnects power from VDDA
		Close*	Connects power to VDDA
JP23	VDD18	Open	Disconnects power from VDD18
		Close*	Connects power to VDD18
JP24	VCORE	Open	Disconnects power from VCORE
		Close*	Connects power to VCORE
JP25	REF0P	2-1*	Connects OB_VREF to REF0P
		2-3	Connects INT_VREF to REF0P
JP26	REF1P	2-1*	Connects OB_VREF to REF1P
		2-3	Connects INT_VREF to REF1P

*Default setting.

Ordering Information

PART	TYPE
MAX32675EVKIT#	EV kit

#Denotes RoHS compliance.

MAX32675 EV Kit Bill of Materials

QTY	VALUE	PART REFERENCE	BOM_DESCRIPTION	MANUFACTURER_PN	MANUFACTURER
12	DNI	C1 C2 C3 C4 C5 C6 C7 C8 C25 C27 C31 C33	DNI		
11	100nF	C9 C11 C12 C16 C17 C18 C20 C21 C26 C32 C40	CAP CER 0.1UF 16V 10% X7R 0402	GRM155R71C104KA88D	Murata Electronics
3	1uF	C10 C15 C22	CAP CER 1UF 10V 20 % X5R 0402	C0402C105M8PACTU	Kemet
2	1nF	C13 C14	CAP CER 1000PF 10V 10% X7R 0402	C0402C102K8RACTU	Kemet
1	1uF	C19	CAP CER 1UF 10V 20 % X5R 0402	C0402C105M8PACTU	Kemet
1	100pF	C23	CAP CER 100PF 50V +/-1% NP0 0402	04025A101FAT2A	AVX Corporation
1	4.7nF	C24	CAP CER 4700PF 50V 5% X7R 0402	GRM155R71H472JA01D	Murata Electronics
2	12pF	C28 C30	CAP CER 12PF 50V 5% NP0 0402	CL05C120JB5NNNC	Samsung Electro-Mech
2	4.7uF	C29 C50	CAP CER 4.7UF 10V 10% X5R 0603	C0603C475K8PACTU	Kemet
3	100nF	C34 C51 C56	CAP CER 0.1UF 10V 10% X5R 0402	GRM155R61A104KA01D	Murata
1	10nF	C35	CAP CER 10000PF 25V 10% X7R 0603	CL10B103KA8NNNC	Samsung Electro-Mech
1	2.2nF	C41	CAP CER 2200PF 50V 5% NP0 0805	GRM2165C1H222JA01D	Murata Electronics
1	10nF	C42	CAP CER 10000PF 50V 5% NP0 0805	GRM2195C1H103JA01D	Murata Electronics
1	1uF	C43	CAP CER 1UF 16V 10% X5R 0402	GRT155R61C105KE01D	Murata Electronics
2	4.7uF	C44 C46	CAP CER 4.7UF 25V 10% X7R 0805	CGA4J1X7R1E475K125AC	TDK Corporation
2	47pF	C45 C47	CAP CER 47PF 50V 1% NP0 0402	C1005C0G1H470F050BA	TDK Corporation
1	2.2uF	C48	CAP CER 2.2uF 10V 10% X5R 0603	C0603C225K8PACTU	Kemet
1	2.2uF	C49	CAP CER 2.2UF 50V 10% X7R 1206	GRM31CR71H225KA88L	Murata Electronics
2	1uF	C53 C58	CAP CER 1uF 16V 10% X7R 0603	GCM188R71C105KA64D	Murata
1	10uF	C54	CAP CER 10UF 6.3V 20% X5R 0603	CL10A106MQ8NNNC	Samsung Electro-Mech
2	10uF	C55 C59	CAP CER 10UF 6.3V 20% X5R 0402	GRJ155R60J106ME11D	Murata Electronics
1	1uF	C57	CAP CER 1UF 6.3V 10% X5R 0402	JMK105BJ105KV-F	Taiyo Yuden
1	MICRO USB B R/A	CN1	CONN RCPT 5POS MICRO USB B R/A	47346-0001	Molex
1	RED	D1	LED 660NM RED WTR CLR 1206 SMD	SML-LX1206SRC-TR	Lumex Opto
4	GRN	D2 D6 D7 D8	LED 565NM WTR CLR GREEN 1206 SMD	SML-LX1206GC-TR	Lumex Opto
2	SMCJ36CA	D3 D4	TVS DIODE 36VWM 58.1VC SMC	SMCJ36CA	Littelfuse Inc
1	BLUE	D5	LED 469NM BLUE DIFF 1206 SMD	HSMR-C150	Avago Technologies
6	DNI	H1 H2 H3 H4 H5 H6	DNI MTG 125DRL 300PAD		
3	SMA	J1 J2 J3	CONN SMA JACK STR 50 OHM PCB	901-10112	Amphenol RF
1	10P CORTEX DEBUG	J4	IDC BOX HEADER 0.050 10 POS SMD	3220-10-0300-00	CNC Tech
1	10P 1x10	JH1	CONN HEADER .100 SINGL STR 10POS	PEC10SAAN	Sullins
1	9P 1x9	JH2	CONN HEADER .100 SINGL STR 9POS	PEC09SAAN	Sullins

MAX32675 EV Kit Bill of Materials (continued)

QTY	VALUE	PART REFERENCE	BOM_DESCRIPTION	MANUFACTURER_PN	MANUFACTURER
3	3P 3x1	JH3 JP25 JP26	CONN HEADER .100 SINGL STR 3POS	PEC03SAAN	Sullins
1	7P 1x7	JH4	CONN HEADER .100 SINGL STR 7POS	PEC07SAAN	Sullins
2	6P 1x6	JH5 JH6	CONN HEADER .100 SINGL STR 6POS	PEC06SAAN	Sullins
1	2P 1x2	JH7	CONN HEADER .100 SINGL STR 2POS	PEC02SAAN	Sullins
2	2P 3.5mm	JH8 JH9	TERM BLOCK 3.5MM VERT 2POS PCB	OSTTE020161	On Shore Technology
20	JUMPER	JP1 JP2 JP3 JP4 JP5 JP6 JP7 JP8 JP10 JP11 JP12 JP13 JP14 JP15 JP19 JP20 JP21 JP22 JP23 JP24	CONN HEADER .100 SINGL STR 2POS	PEC02SAAN	Sullins
1	8P 2x4	JP9	CONN HEADER .100 DUAL STR 8POS	PEC04DAAN	Sullins
1	HZ1206C202R-10	L1	FERRITE CHIP SIGNAL 2000 OHM SMD	HZ1206C202R-10	Laird-Signal Integrity
1	BLM21PG221SN1D	L2	FERRITE CHIP 220 OHM 0805	BLM21PG221SN1D	Murata Electronics
1	PCB	PCB1			
1	FDV304P	Q1	MOSFET P-CH 25V 460MA SOT-23	FDV304P	Fairchild Semiconductor
1	TLP3545(F)	Q2	PHOTOCOUPLER PHOTORELAY 6-DIP	TLP3545(F)	Toshiba Semiconductor
2	BSS806N	Q3 Q4	MOSFET N-CH 20V 2.3A SOT23	BSS806N H6327	Infineon Technologies
18	0	R1 R2 R3 R4 R5 R6 R7 R8 R22 R23 R24 R26 R27 R28 R29 R30 R32 R33	RES SMD 0 OHM JUMPER 1/10W 0603	RC0603JR-070RL	Yageo
2	100	R9 R10	RES SMD 100 OHM 1% 1/10W 0603	RC0603FR-07100RL	Yageo
1	470	R11	RES 470 OHM 1/10W 1% 0603 SMD	ERJ-3EKF4700V	Panasonic
4	332	R12 R55 R57 R61	RES 332 OHM 1/10W 1% 0603 SMD	ERJ-3EKF3320V	Panasonic
4	10K	R13 R14 R18 R39	RES 10K OHM 1/10W 1% 0603 SMD	ERJ-3EKF1002V	Panasonic
2	27	R15 R17	RES 27 OHM 1/10W 1% 0603 SMD	ERJ-3EKF27R0V	Panasonic
1	0	R16	RES SMD 0 OHM JUMPER 1/10W 0603	RC0603JR-070RL	Yageo
2	4.75K	R25 R31	RES 4.75K OHM 1/10W 1% 0603 SMD	ERJ-3EKF4751V	Panasonic
1	1M	R37	RES SMD 1M OHM 5% 1/8W 0805	ERJ-6GEYJ105V	Panasonic
1	1.58K	R40	RES 1.58K OHM 1/10W 1% 0603 SMD	ERJ-3EKF1581V	Panasonic
1	221K	R41	RES 221K OHM 1/10W 1% 0603 SMD	ERJ-3EKF2213V	Panasonic
1	301K	R42	RES 301K OHM 1/10W 1% 0603 SMD	ERJ-3EKF3013V	Panasonic
2	10	R43 R51	RES 10 OHM 1/10W 1% 0603 SMD	ERJ-3EKF10R0V	Panasonic
2	249	R44 R50	RES 249 OHM 1W 1% 2512 SMD	MCR100JZH2490	Rohm Semiconductor
1	49.9	R45	RES 49.9 OHM 1/10W 1% 0603 SMD	ERJ-3EKF49R9V	Panasonic
1	100K	R47	RES 100K OHM 1/10W 1% 0603 SMD	ERJ-3EKF1003V	Panasonic
1	3.32K	R56	RES 3.32K OHM 1/10W 1% 0603 SMD	ERJ-3EKF3321V	Panasonic

MAX32675 EV Kit Bill of Materials (continued)

QTY	VALUE	PART REFERENCE	BOM_DESCRIPTION	MANUFACTURER_PN	MANUFACTURER
2	150K	R58 R62	RES 150K OHM 1/10W 1% 0603 SMD	ERJ-3EKF1503V	Panasonic
1	12.4K	R59	RES SMD 12.4K OHM 1% 1/10W 0402	ERJ-2RKF1242X	Panasonic
1	49.9K	R60	RES 49.9K OHM 1/10W 1% 0603 SMD	ERJ-3EKF4992V	Panasonic
6	DNI	SH1 SH2 SH3 SH4 SH5 SH6	DNI 2 NET SHORT		
2	B3S-1000P	SW1 SW2	SWITCH TACTILE SPST-NO 0.05A 24V	B3S-1000P	Omron Electronics
1	B3S-1002 BY OMZ	SW3	SWITCH TACTILE SPST-NO 0.05A 24V	B3S-1002 BY OMZ	Omron Electronics
1	SPDT 3A	SW4	SWITCH TOGGLE SPDT 3A 120V	ET01MD1AGE	C&K Components
1	CL-SB-12A-01T	SW5	SWITCH SLIDE SPDT 200MA 12V	CL-SB-12A-01T	Nidec Copal Electronics
1	MET-26	T1	TRANSFORMER 1KCT:1KCT 3.0MADC	MET-26	Tamura
3	BLK	TP1 TP2 TP3	TEST POINT PC MULTI PURPOSE BLK	5011	Keystone Electronics
1	BRWN	TP9	TEST POINT PC MULTIPURPOSE BRWN	5125	Keystone Electronics
2	BLUE	TP10 TP12	TEST POINT PC MULTI PURPOSE BLUE	5127	Keystone Electronics
1	PRPL	TP11	TEST POINT PC MULTI PURPOSE PRPL	5129	Keystone Electronics
3	YLW	TP13 TP15 TP16	TEST POINT PC MULTI PURPOSE YEL	5014	Keystone Electronics
1	MAX32675ATK 68P QFN SKT	U1	MAX32675ATK 68P QFN SKT	68QHC40A28080	Plastronics
1	MAX3207EAUT+T	U2	ESD PROT DIFF SOT23-6	MAX3207EAUT+T	Maxim Integrated
1	FT231XS-R	U3	IC USB SERIAL FULL UART 20SSOP	FT231XS-R	FTDI
1	NC7WZ08K8X	U4	IC GATE AND 2CH 2-INP US8	NC7WZ08K8X	ON Semiconductor
1	MAX1806EUA33+	U6	IC REG LDO 3.3V/ADJ 0.5A 8UMAX	MAX1806EUA33+	Maxim Integrated
2	MAX1806EUA18+	U7 U8	Low Dropout Linear Regulator	MAX1806EUA18+	Maxim Integrated
2	MAX6071AAUT21+T	U9 U10	IC VREF SERIES 0.04% SOT23-6	MAX6071AAUT21+T	Maxim Integrated
1	16MHz	Y1	CRYSTAL 16.0000MHZ 9PF SMD	ECS-160-9-42-CKM-TR	ECS Inc.

MAX32675 EV Kit Schematics

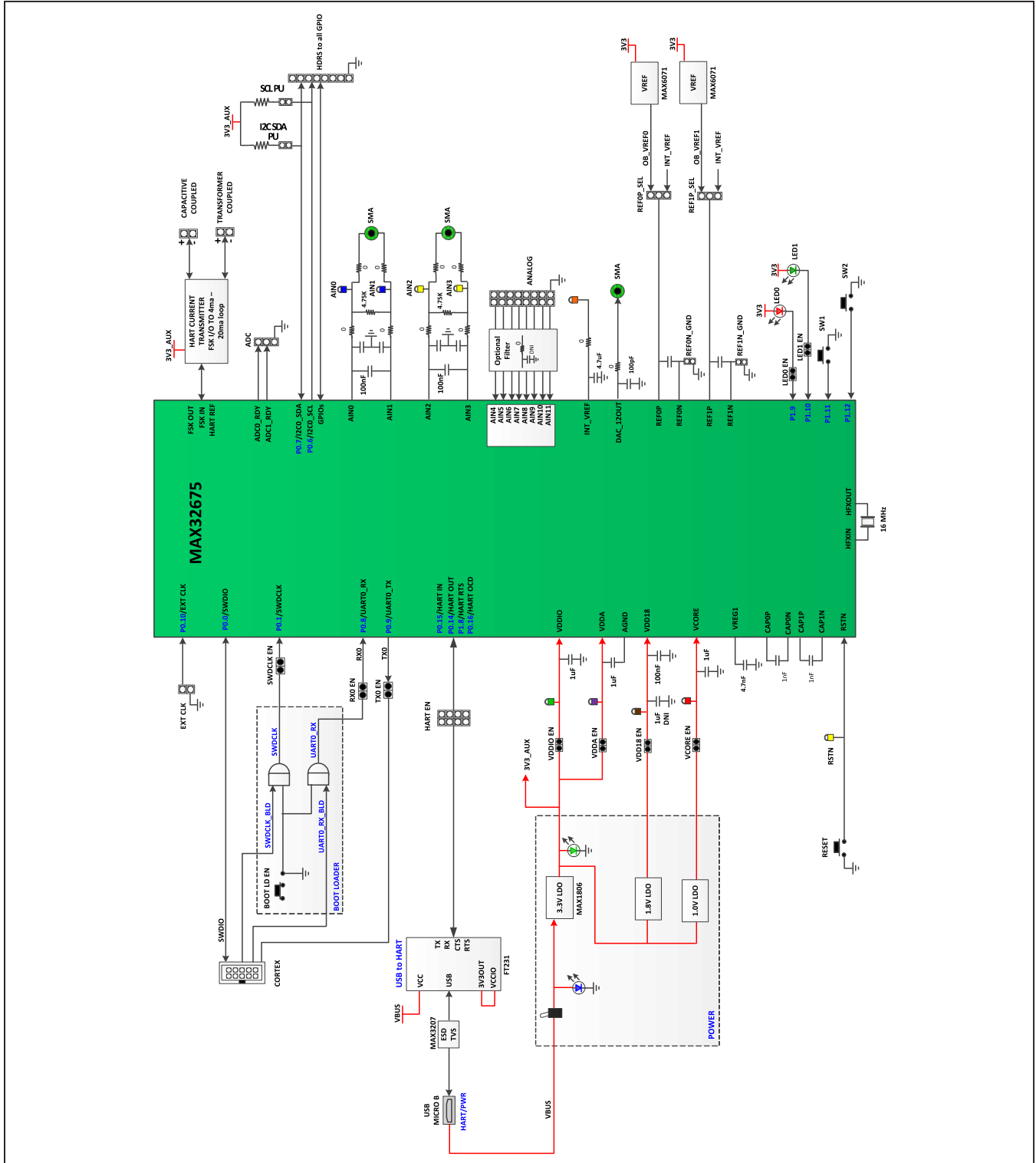

MAX32675 EV Kit Schematics (continued)

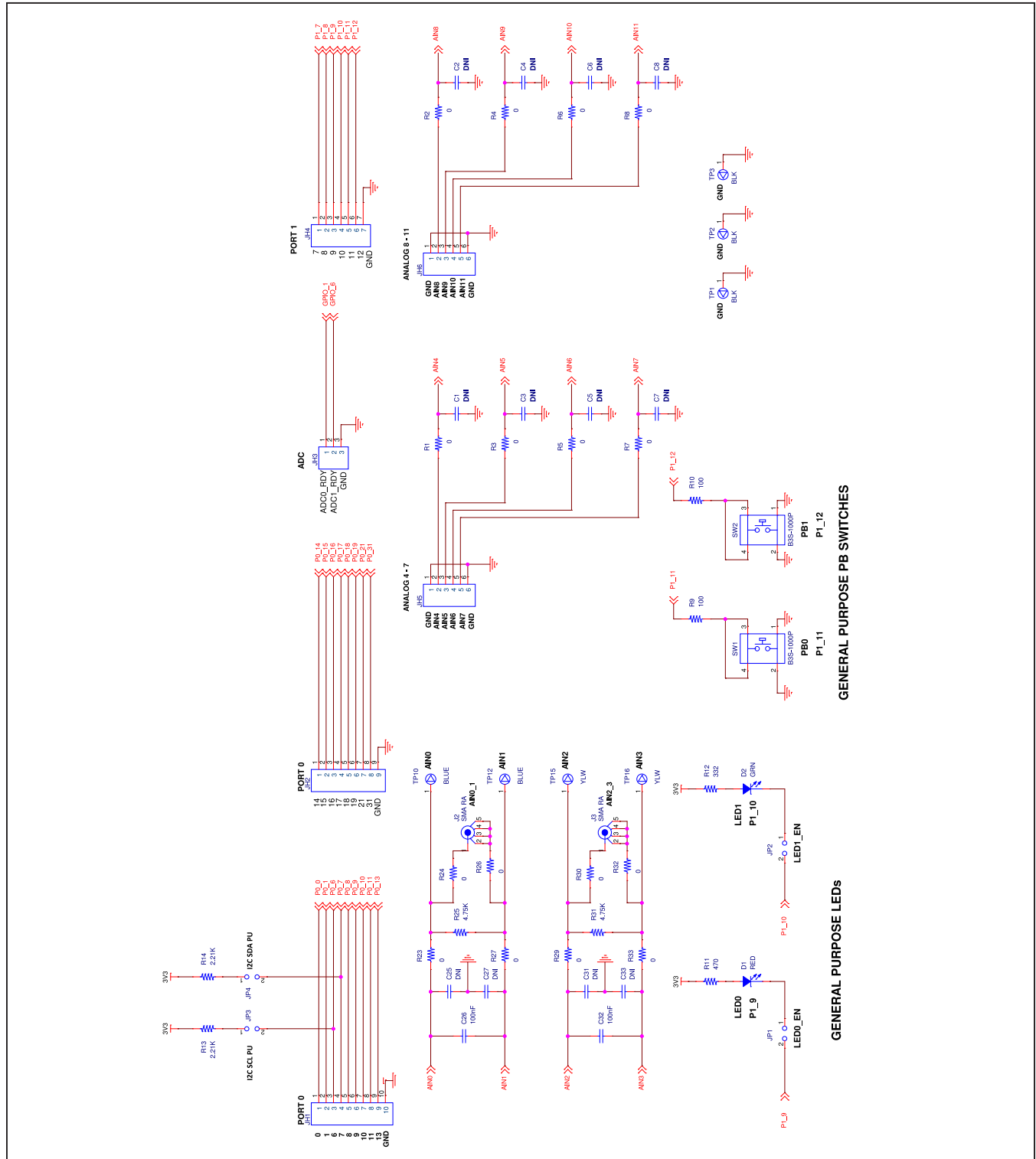

MAX32675 EV Kit Schematics (continued)

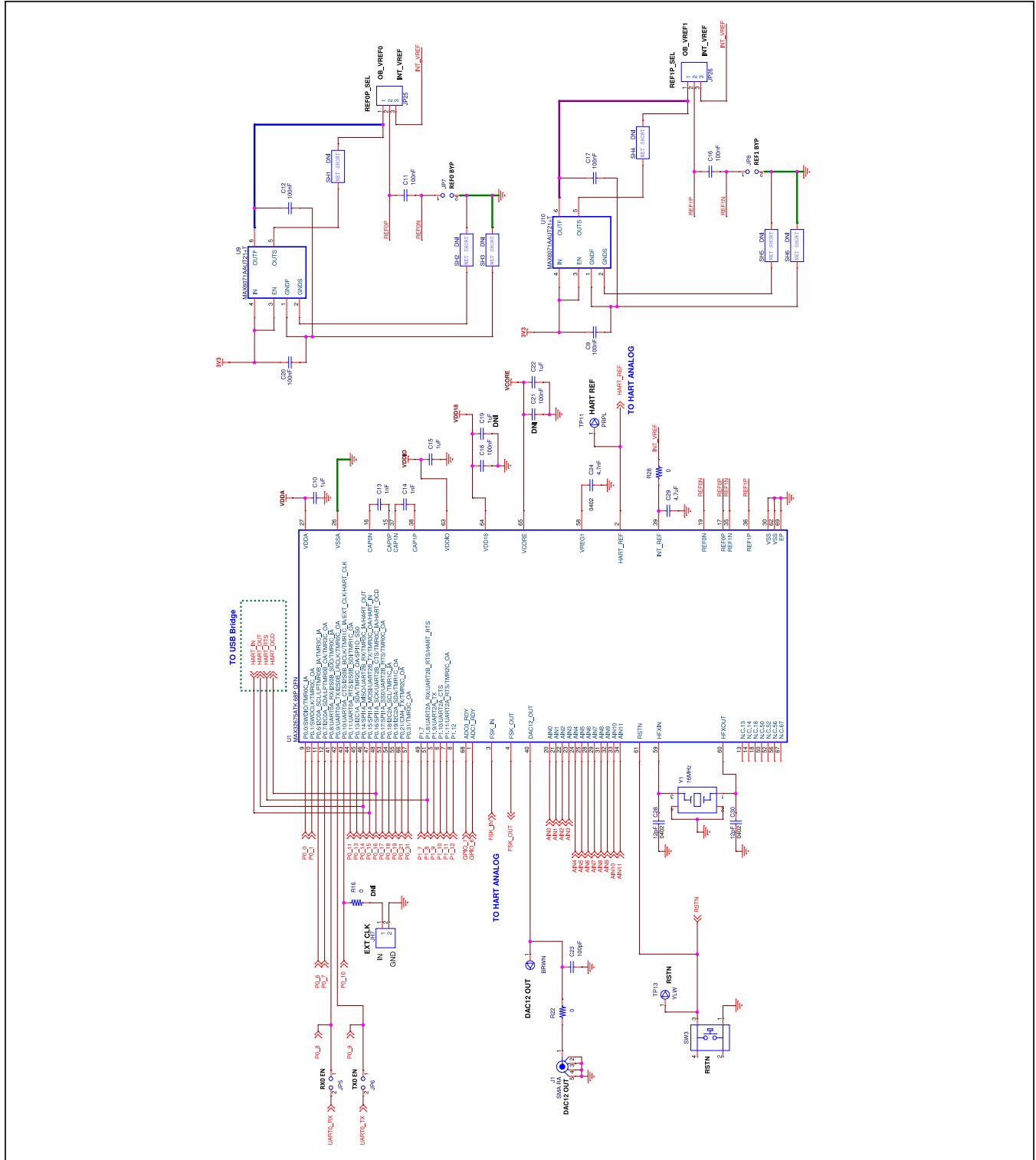

MAX32675 EV Kit Schematics (continued)

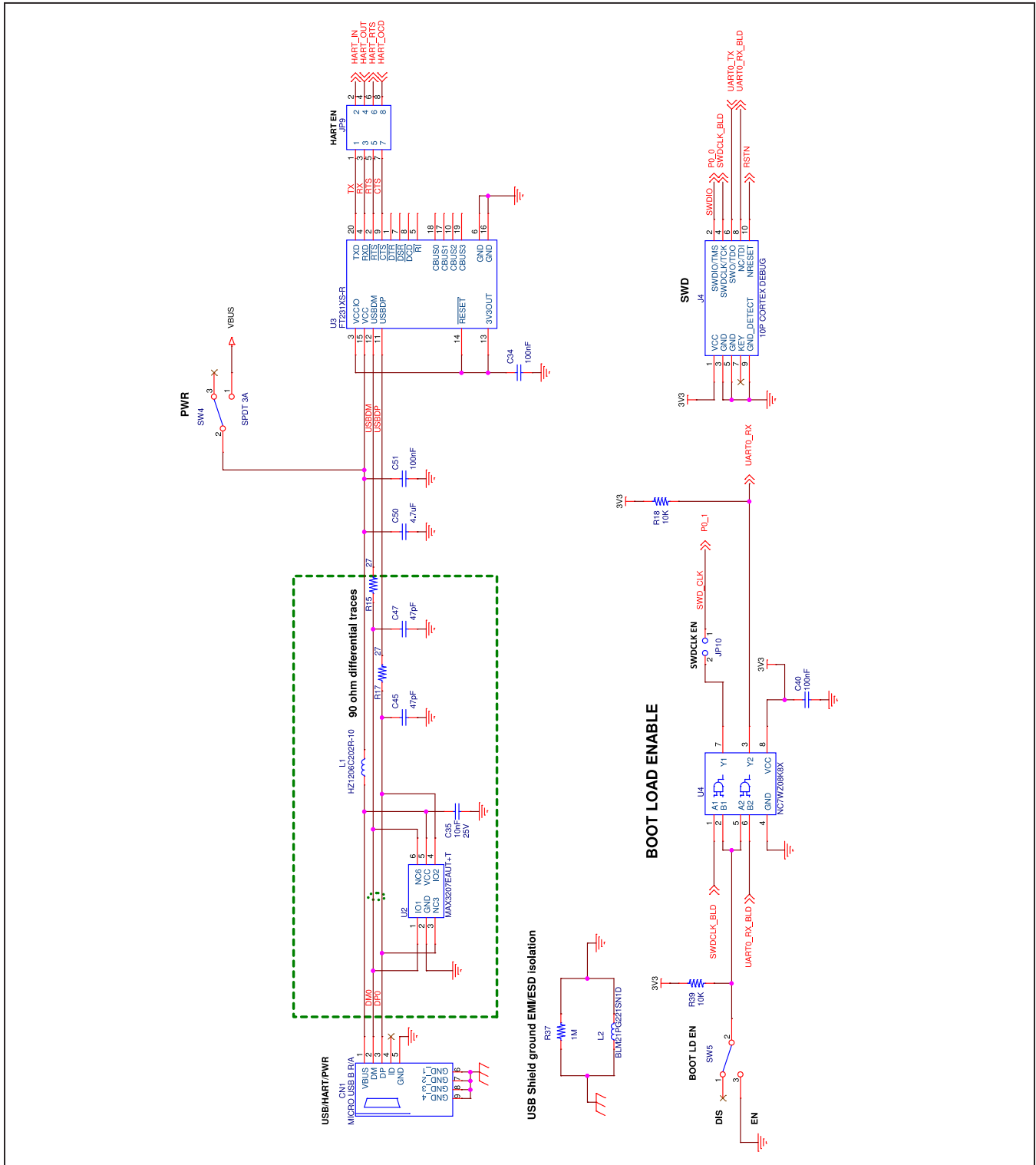

MAX32675 EV Kit Schematics (continued)

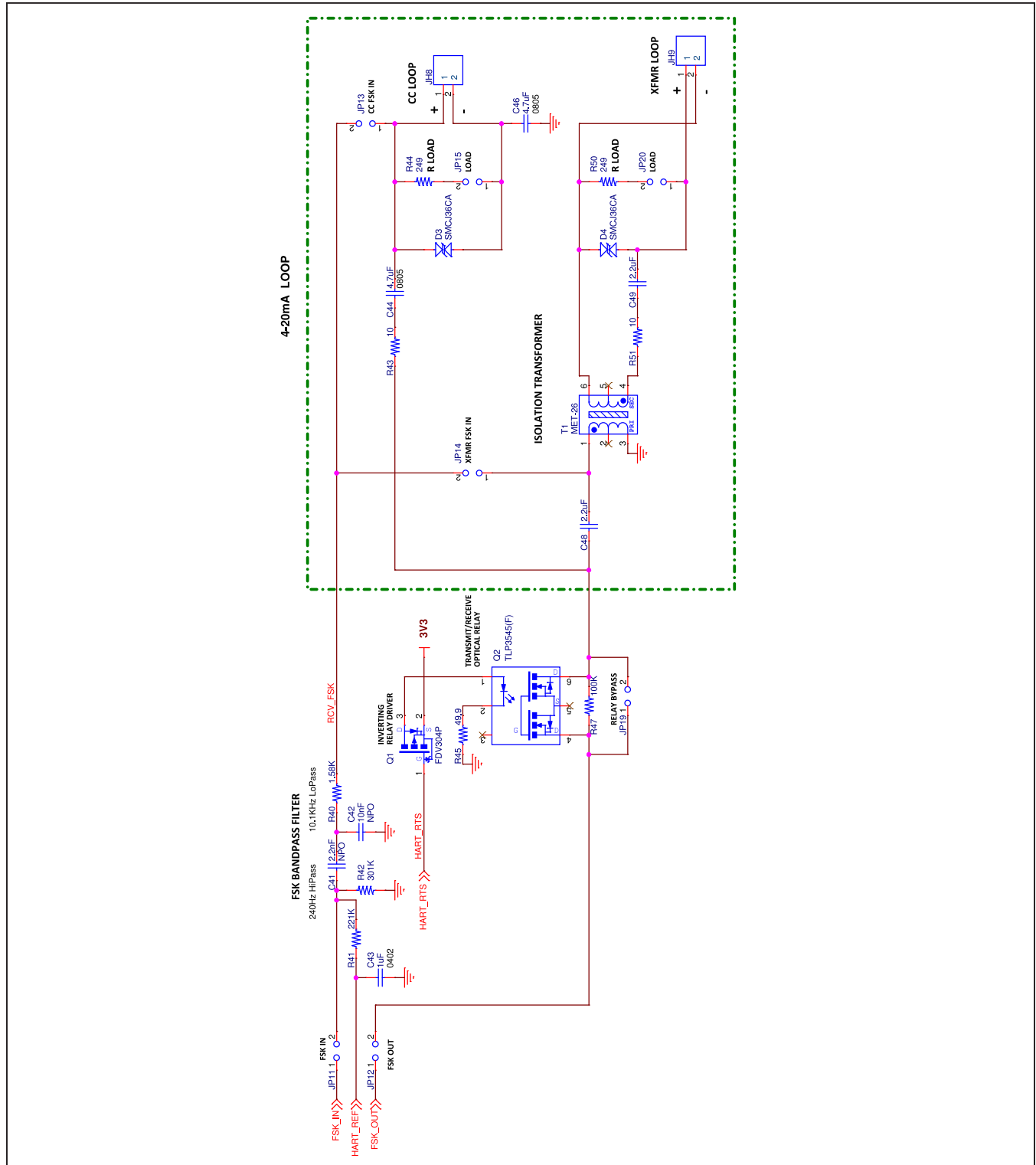

MAX32675 EV Kit Schematics (continued)

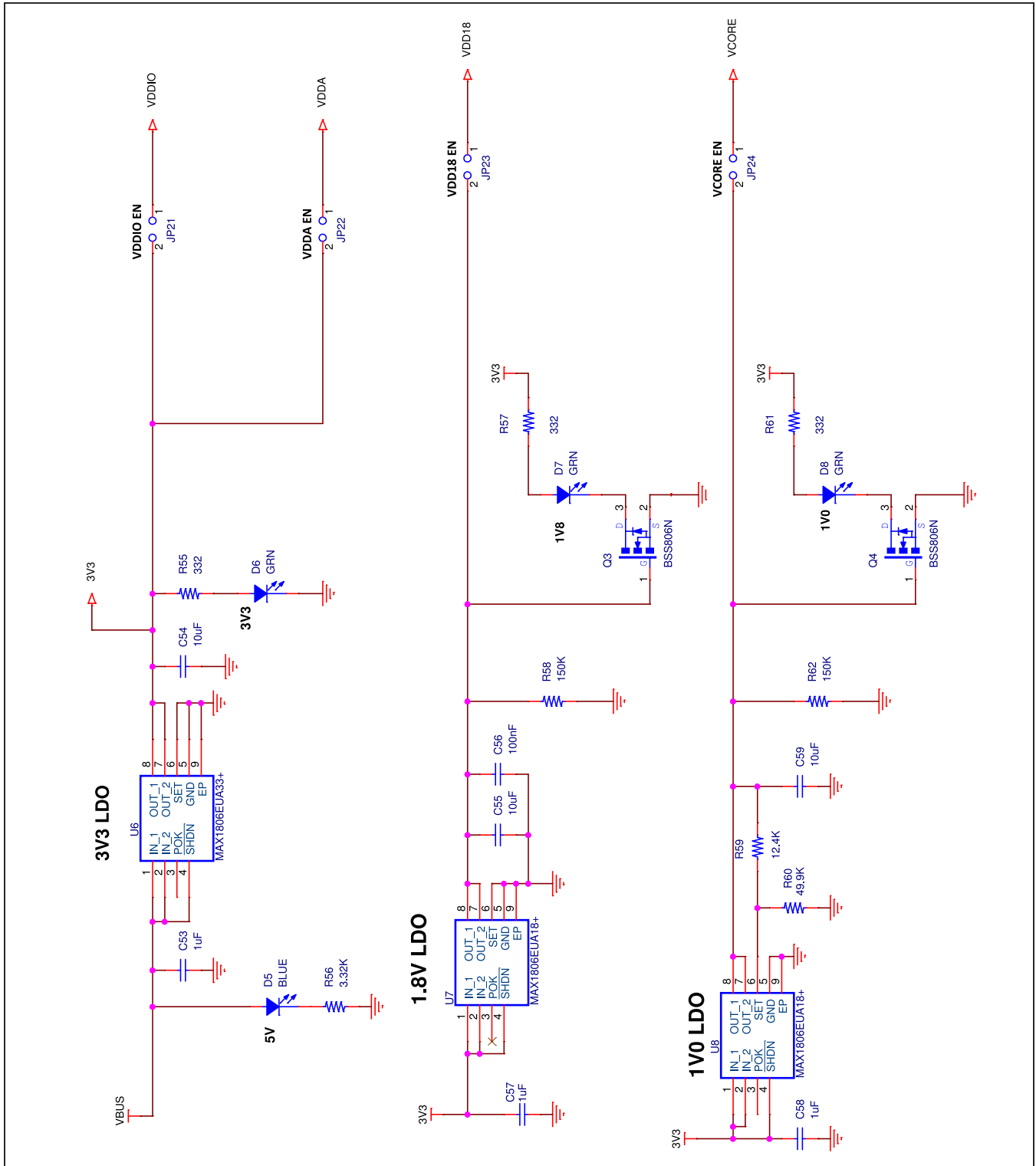

Revision History

REVISION NUMBER	REVISION DATE	DESCRIPTION	PAGES CHANGED
0	4/21	Initial release	—
1	5/22	Updated <i>MAX32675 EV Kit Board</i> photos, <i>Quick Start</i> , <i>Detailed Description of Hardware (or Software)</i> , <i>Table 1</i> , <i>MAX32675 EV Kit Bill of Materials</i> and <i>MAX32675 EV Kit Schematics</i> .	1–14



Information furnished by Analog Devices is believed to be accurate and reliable. However, no responsibility is assumed by Analog Devices for its use, nor for any infringements of patents or other rights of third parties that may result from its use. Specifications subject to change without notice. No license is granted by implication or otherwise under any patent or patent rights of Analog Devices. Trademarks and registered trademarks are the property of their respective owners.