

R8100SD

REED INSTRUMENTS

Data Logging Light Meter



Instruction Manual

REED Instruments

1-877-849-2127 | info@reedinstruments.com | www.reedinstruments.com

Table of Contents

Introduction	3
Product Quality.....	3
Safety	3
Features	4
Included	4
Specifications	4-5
Instrument Description	6
Display Description	7
Operating Instructions.....	8-10
<i>Power ON/OFF</i>	8
<i>Selecting Measurement Modes</i>	8
<i>Light Measurement</i>	8
<i>Changing the Light Meter unit of Measure</i>	9
<i>Zero Adjustment</i>	9
<i>Type K/J Thermocouple Measurement Mode</i>	9
<i>Data Hold</i>	10
<i>Recording Maximum and Minimum Readings</i>	10
<i>Backlight</i>	10
Setup Mode	11-14
<i>Setting the Time and Date (dAtE)</i>	11
<i>Setting the Data Logging Sampling Rate (SP-t)</i>	12
<i>Enabling/Disabling Auto Power Off (PoFF)</i>	12
<i>Enabling/Disabling the Beeper (bEEP)</i>	12
<i>Setting Data Decimal Format (dEC)</i>	12-13
<i>Formatting the SD Card (Sd F)</i>	13
<i>Selecting the Temperature Unit of Measure (t-CF)</i>	13
<i>Selecting Thermocouple Type (tYPE)</i>	13
<i>Verify Set Time, Date and Sampling Rate</i>	14
Data Logging.....	14-16
<i>Data Recording Modes</i>	14
<i>Manual Data Logging Mode</i>	14

continued...

<i>Automatic Data Logging Mode</i>	15
<i>Transferring Data from the SD Memory Card to a Computer</i>	15-16
Data Stream Output	16
<i>3.5mm Terminal to RS-232 Serial Connection</i>	16
System Reset	17
Battery Replacement	17
Applications	17
Accessories and Replacement Parts	18
Frequently Asked Questions (FAQ's)	18-19
Product Care	19
Product Warranty	20
Product Disposal and Recycling	20
Product Support	20

Introduction

Thank you for purchasing your REED R8100SD Data Logging Light Meter. Please read the following instructions carefully before using your instrument. By following the steps outlined in this manual your meter will provide years of reliable service.

Product Quality

This product has been manufactured in an ISO9001 facility and has been calibrated during the manufacturing process to meet the stated product specifications. If a certificate of calibration is required please contact the nearest authorized REED distributor or authorized Service Center. Please note an additional fee for this service will apply.

Safety

Never attempt to repair or modify your instrument. Dismantling your product, other than for the purpose of replacing batteries, may cause damage that will not be covered under the manufacturer's warranty. Servicing should only be provided by an authorized service center.

Features

- Measures ambient light levels in Foot Candles or Lux
- Photo diode and colour correction filters meet C.I.E. spectrum specifications
- Contact temperature measurement with a type J/K thermocouple option
- Temperature is measured in °C or °F
- Real time data logger with integrated SD memory card
- User selectable sampling rate from 1 to 3600 seconds
- Easy-to-read backlit LCD display
- Data hold and Min/Max functions
- Tripod mount for long-term monitoring
- Low battery indicator and auto shut off

Included

- Detachable Sensor
- Sensor Cover
- Soft Carrying Case
- Batteries

Specifications

Measuring Ranges:	Lux: 2,000, 20,000, 100,000 Fc: 200, 2,000, 10,000 Type K Temperature: -148.0 to 2,372.0°F (-100.0 to 1,300°C) Type J Temperature: -148.0 to 2,192.0°F (-100.0 to 1,200°C)
Accuracy:	Lux: $\pm(4\% + 2 \text{ Lux})$ Fc: $<2,000: \pm(4\% \text{ rdg.} + 2 \text{ Fc})$ $2,000-10,000: \pm(4\% \text{ rdg.} + 20 \text{ Fc})$ Temp: $\geq -58^\circ\text{F} (-50^\circ\text{C}) \pm(0.4\% + 1^\circ\text{F} (0.5^\circ\text{C}))$ $\leq -58^\circ\text{F} (-50^\circ\text{C}) \pm(0.4\% + 1.8^\circ\text{F} (1^\circ\text{C}))$
Resolution:	Lux: 1, 10, 100 Fc: 0.1, 1, 10 Temp: 0.1°F (0.1°C)

continued...

REED Instruments

1-877-849-2127 | info@reedinstruments.com | www.reedinstruments.com

Response Time:	<1 second
Sensor Type:	Photo diode & color correction filter
Autoranging:	Yes
Display:	5-digit LCD
Backlit Display:	Yes
Data Hold:	Yes
Min:	Yes
Max:	Yes
Auto Zero:	Yes
Overrange Indicator:	Yes
Datalogging Capabilities:	Yes
Real-Time Clock and Date Stamp:	Yes
Sampling Rate:	Yes (1, 2, 5, 10, 30, 60, 120, 300, 600, 1800, 3600s)
External Memory:	Yes, expandable up to 16GB with SD card (optional)
Auto Shut-off:	Yes (after 10 minutes/off)
Kick Stand:	Yes
Tripod Mountable:	Yes
Low Battery Indicator:	Yes
Power Supply:	6 x AA batteries or AC Adapter (optional)
Data Output:	Yes (RS-232)
Battery Life:	Sampling Time Dependent
Product Certifications:	CE
Operating Temperature:	32 to 122°F (0 to 50°C)
Storage Temperature:	14 to 140°F (-10 to 60°C)
Operating Humidity Range:	10 to 80%
Dimensions:	7 x 2.7 x 1.9" (117 x 68 x 45mm)
Weight:	17.3oz (489g)

Instrument Description

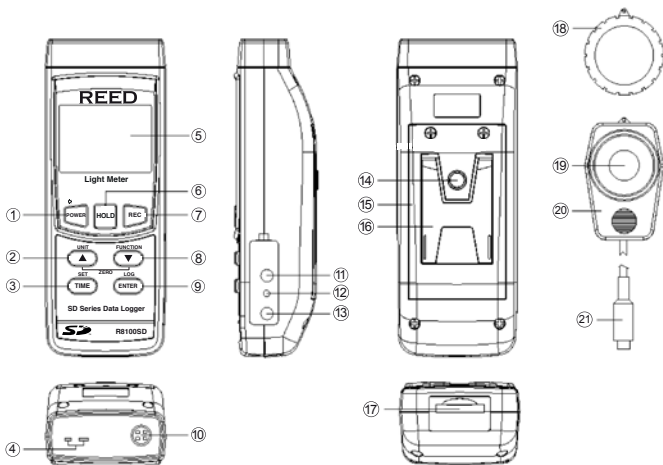

- | | |
|-------------------------------------|---------------------------|
| 1. POWER/Backlight/ESC Button | 11. RS232 Output Jack |
| 2. Up/UNIT Button | 12. Reset Pin |
| 3. TIME/SET Button | 13. Power Adapter Input |
| 4. Type K/J Thermocouple Input Jack | 14. Tripod Mounting Screw |
| 5. LCD Display | 15. Battery Cover |
| 6. HOLD Button | 16. Kickstand |
| 7. REC Button | 17. SD Card Slot |
| 8. Down/FUNCTION Button | 18. Light Sensor Cover |
| 9. ENTER/LOG Button | 19. Light Sensor |
| 10. Light Sensor Input Socket | 20. Light Sensor Handle |
| | 21. Light Sensor Plug |

Display Description

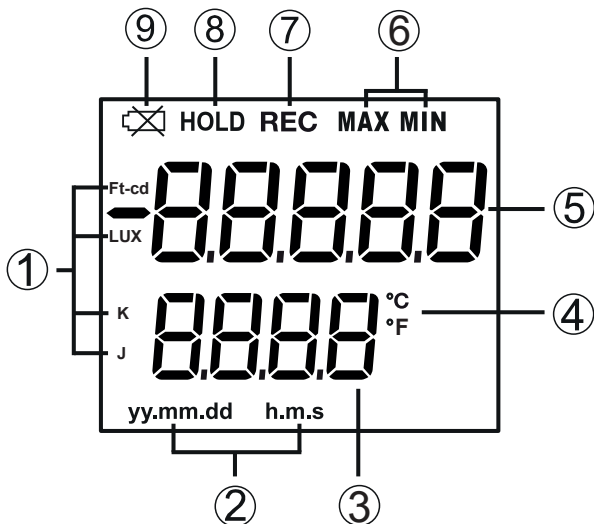

1. Units of Measure
2. Date & Time Values/Temperature Measurement Reading
3. Date/Time Stamp
4. Temperature Unit of Measure
5. Measurement Reading Indicator
6. Maximum and Minimum Indicators
7. Record Mode Indicator
8. Data Hold Indicator
9. Low Battery Indicator

Operating Instructions

Power ON/OFF

To turn the meter on or off, press and hold the **POWER** button for 2 seconds.

Note: This meter can be powered by either six (6) "AA" batteries or AC adapter (sold separately).

Selecting Measurement Modes

The R8100SD offers 2 types of measurement modes to choose from:

- Light Meter
 - Type K/J Thermometer
1. When the meter is on, press and hold the **FUNCTION** button to toggle between "LiGHT" for light meter and "tP" for Type K/J Thermometer measurement modes of operation.
 2. Release the **FUNCTION** button to confirm selection.

Light Measurement

1. When the meter is off, plug the probe into the probe input socket, then power on the meter by pressing the **POWER** button.
2. Select the "LigHt" measurement mode (see *Selecting Measurement Modes* for details).
3. Hold the probe handle and face the probe head against the measuring light source.
4. The display will show the light measurement value as shown below.

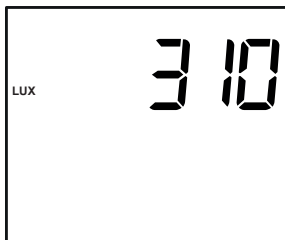

continued...

REED Instruments

1-877-849-2127 | info@reedinstruments.com | www.reedinstruments.com

Changing the Light Meter unit of Measure

1. Press and hold the UNIT button, while in the Light Meter measurement mode.
2. The LCD display will toggle between the units LUX and Ft-cd.
3. Release the UNIT button to select the displayed unit.
4. The selected unit will be saved as the new default.

Zero Adjustment

1. While taking a light measurement, completely cover the light sensor.
2. If the LCD display does not show value of zero, press the ▲ and ▼ buttons simultaneously until the LCD display shows a zero value.

Type K/J Thermocouple Measurement Mode

1. Select the "tP" function (see *Selecting Measurement Modes* for details).
2. Plug the optional Type K or J Thermocouple Probe into the Type K/J thermocouple input jack.
3. The screen will display a "K", confirming that is configured by default to a Type K thermocouple probe. The measured temperature will now be displayed on the display screen. As shown below.

Note: If using a type J thermocouple probe, see *Selecting Measurement Modes* for details.

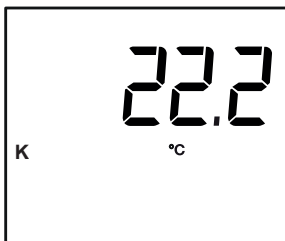

continued...

Data Hold

1. While taking a measurement, press the **HOLD** button to freeze the current readings on the display.
2. While in this mode, a "HOLD" symbol will appear.
3. Press the **HOLD** button again to resume normal operation.

Note: When the Data Hold feature is active all buttons except the **POWER** button are disabled.

Recording Maximum and Minimum Readings

1. Press the **REC** button to enter recording mode as indicated by "REC" on the LCD. The meter will now begin recording maximum and minimum readings.
2. While in recording mode;
 - A) Press the **REC** button once and the maximum value will appear on the display as indicated by "REC MAX".
 - B) Press the **REC** button again and the minimum value will appear on the display as indicated by "REC MIN".
 - C) To exit recording mode and resume normal operation, press and hold the **REC** button for two seconds.

When in recording mode the **POWER** button is disabled and the meter cannot be turned off.

Backlight

After powering the meter ON, the LCD Backlight will turn on automatically. Press the BACKLIGHT button to turn the LCD Backlight on or off.

Setup Mode

1. Press and hold the **SET** button for 2 seconds to enter Setup Mode.
2. Press the **SET** button continuously to scroll through the following parameters.

Parameter	Description
dAtE	Set the time and date
SP-t	Set the data logging sampling rate
PoFF	Enable or disable the auto-power off function
bEEP	Turn the beeper on or off
dEC	Set the decimal format (USA (20.00) or European (20,00))
Sd F	Format the SD memory card
t-CF	Select the temperature unit of measure (°C or °F)
tYPE	Select thermocouple type (K or J)

3. Once the appropriate parameter has been selected, follow the instructions below.

Note: The meter automatically exit out of the Setup mode if no key is pressed within 7 seconds.

Setting the Time and Date (dAtE)

1. Press the **ENTER** button when "dAtE" appears on the LCD.
2. Press the ▲ and ▼ buttons to adjust the year as indicated by "YY."
3. Press the **ENTER** button to confirm selection.
4. Repeat steps 2 and 3 for month, day, hour, minute and seconds as indicated by (mm/dd/h/m/s).
5. After each value has been selected and confirmed, the meter will automatically skip to the next parameter.

Note: At any time, you can press the **POWER** button to exit the Setup mode and resume normal operation. The internal clock will keep accurate time when the meter is powered off. When new batteries are installed the clock will have to be reset.

continued...

Setting the Data Logging Sampling Rate (SP-t)

Follow steps 1 and 2 when "SP-t" appears on the LCD.

1. Press the ▲ and ▼ buttons to adjust the sampling rate between 0, 1, 2, 5, 10, 30, 60, 120, 300, 600, 1800, and 3600 seconds.
2. Press the **ENTER** button to confirm selection and skip to the next parameter.

Note: At any time, you can press the **POWER** button to exit the Setup mode and resume normal operation.

Enabling/Disabling Auto Power Off (PoFF)

Follow steps 1 and 2 when "PoFF" appears on the LCD.

1. Press the ▲ and ▼ buttons to select between YES (enabled) or NO (disabled). With the Auto Power OFF feature enabled, the meter will automatically switch OFF after 10 minutes of inactivity to preserve battery life.
2. Press the **ENTER** button to confirm selection and skip to the next parameter.

Note: At any time, you can press the **POWER** button to exit the Setup mode and resume normal operation.

Enabling/Disabling the Beeper (bEEP)

Follow steps 1 and 2 when "bEEP" appears on the LCD.

1. Press the ▲ and ▼ buttons to select between ON (enabled) or OFF (disabled).
2. Press the **ENTER** button to confirm selection and skip to next parameter.

Note: At any time, you can press the **POWER** button to exit the Setup mode and resume normal operation.

Setting Data Decimal Format (dEC)

Numeric formats vary in different countries. By default the meter is set to bASIC mode where a decimal point is used to separate units, (i.e. 20.00). The European format uses a comma (i.e. 20,00) to separate units. To change this setting, follow steps 1 and 2 when "dEC" appears on the LCD.

continued...

1. Press the ▲ and ▼ buttons to select between BASIC and Euro.
2. Press the **ENTER** button to confirm selection and skip to next parameter.

Note: At any time, you can press the **POWER** button to exit the Setup mode and resume normal operation.

Formatting the SD Card (Sd F)

Follow steps 1 through 5 when "Sd F" appears on the LCD.

1. Press the ▲ and ▼ buttons to select "YES" to format the card. Select "NO" to abort.
2. Press the **ENTER** button to confirm selection.
3. Press the **ENTER** button again to re-confirm.
4. The meter will format the SD card while flashing "For-" and automatically return to the Setup menu when formatting is complete.
5. Press the **POWER** button to exit the Setup mode and resume normal operation.

Note: At any time, you can press the **POWER** button to exit the Setup mode and resume normal operation. It is recommended that new SD cards should be formatted prior to first use. If the formatting process fails or if no card is inserted, the meter will display "Sd -E-".

Selecting the Temperature Unit of Measure (t-CF)

Follow steps 1 through 3 when "t-CF" appears on the LCD.

1. Press the ▲ and ▼ buttons to select between °C and °F.
2. Press the **ENTER** button to confirm selection.
3. Press the **SET** button to save the selected sampling rate and jump to next parameter.

Note: At any time, you can press the **POWER** button to exit the Setup mode and resume normal operation.

Selecting Thermocouple Type (tYPE)

Follow steps 1 and 2 when "tYPE" appears on the LCD.

1. Press the ▲ and ▼ buttons to select between K and J.
2. Press the **ENTER** button to confirm selection and skip to next parameter.

Note: At any time, you can press the **POWER** button to exit the Setup mode and resume normal operation.

Verify Set Time, Date and Sampling Rate

During normal operation press the **TIME** button to display the year, month, day, hour, minutes and selected sampling rate.

Data Logging

Data Recording Modes

Manual Data Logging: Press the **LOG** button to manually log up to 99 readings on a SD memory card (see *Manual Data Logging Mode* for full setup instructions).

Automatic Data Logging: Setup the meter parameters in order to automatically log data on a SD memory card. The number of data points is limited by the size of the memory card.

Note: It is recommended to use a class 4 SDHC memory card between 1 and 16Gb. Insert the SD memory card in the slot at the bottom of the meter. The card must be inserted with the label side facing the rear of the meter.

Manual Data Logging Mode

In manual mode, the LOG button is pressed to manually log a reading on the inserted SD card at any time. In order to setup the meter for manual data logging, follow steps 1 through 5 below.

1. Set the data logging sampling rate to "0" seconds (see *Setting the Data Logging Sampling Rate* for details).
2. Press and hold the LOG button for 2 seconds at which point the lower portion of the LCD will display P-X (X = memory position number between 1 and 99).
3. Press the ▲ and ▼ buttons to select one of the 99 data memory positions in which to record.
4. Press the LOG button again to save a reading to memory. "REC" will flash each time a data point is stored.

Note: If a card is not inserted or the card is defective, the meter will flash "Sd -E-". In this case, power the meter OFF and try again with another SD memory card or verify that the card is correctly inserted.

5. To exit manual data logging mode, press and hold the LOG button 2 seconds to resume normal operation.

continued...

Automatic Data Logging Mode

In automatic mode the desired data logging sampling rate is set to 1, 2, 5, 10, 30, 60, 120, 300, 600, 1800 or 3600 seconds prior to recording. In order to setup the meter for automatic data logging, follow steps 1 through 4 below.

1. To begin a data logging session press and hold the LOG button for 2 seconds. The meter will scan for a SD memory card.

Note: If a card is not inserted or the card is defective, the meter will flash "Sd -E-" indefinitely. In this case, power the meter OFF and try again with another SD memory card or verify that the SD card is correctly inserted.

2. While in a data logging session, the "LoG" icon will appear on the LCD, while the REC icon will continuously flash.
3. To pause the data logging session press the LOG button and REC will stop flashing. To resume press the LOG button again.
4. To end the current data logging session press and hold the LOG button for 2 seconds.

Transferring Data from the SD Memory Card to a Computer

1. While the meter is powered Off remove the SD memory card from the SD card slot.
2. Insert the SD memory card into the computer.
3. Open the file(s) with Excel. See sample below:

Place	Date	Time	Value	Unit
1	19-07-10	10:39:08	886	LUX
2	19-07-10	10:39:09	886	LUX
3	19-07-10	10:39:11	169	LUX
4	19-07-10	10:39:13	1036	LUX
5	19-07-10	10:39:15	999	LUX
6	19-07-10	10:39:17	25	LUX
7	19-07-10	10:39:19	991	LUX
8	19-07-10	10:39:21	960	LUX
9	19-07-10	10:39:23	969	LUX
10	19-07-10	10:39:25	30	LUX
11	19-07-10	10:39:27	999	LUX
12	19-07-10	10:39:29	971	LUX
13	19-07-10	10:39:31	985	LUX

continued...

The raw data can be used to create a graph in Excel. See sample below:

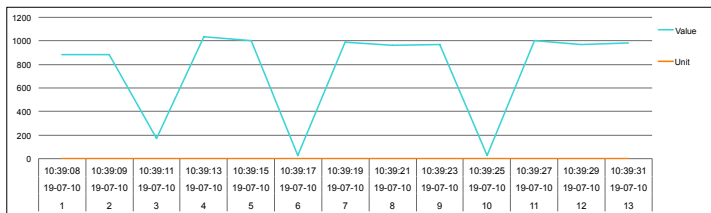

Data Stream Output

Using Terminal application, a data stream can be viewed from the RS-232 output, connect RS-232/USB cable between the product and terminal/PC and use the following setting to view the data stream.

Terminal Settings:

- Bits per second: 9600
- Data bits: 8
- Parity: None
- Stop bits: 1

41010100000501 = Upper Value, 301 LUX

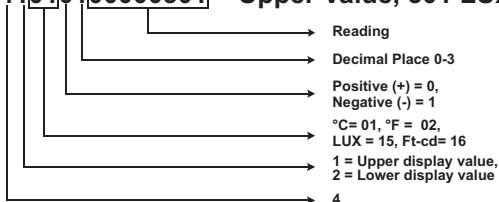

3.5mm Terminal to RS-232 Serial Connection

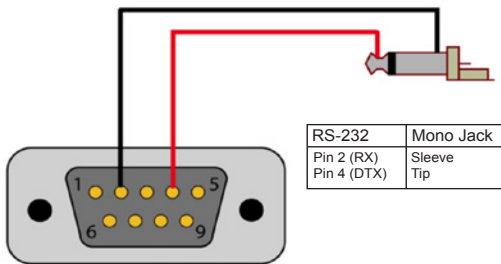

REED Instruments

1-877-849-2127 | info@reedinstruments.com | www.reedinstruments.com

System Reset

If the meter becomes unresponsive or if the display freezes, the Reset pin can be used to reset the instrument.

1. Use a paper clip or any similar small object to press the Reset pin.
2. After pressing the Reset pin, power the meter back up by holding the **POWER** button for 2 seconds.
3. If resetting the meter does not resolve the issue, please return the meter to the nearest authorized REED distributor or authorized Service Center for repair.

Battery Replacement

When the low battery icon  appears on the LCD, the batteries must be replaced.

1. Remove the two (2) Phillips screws on the back of the meter directly located above the top of the kickstand.
2. Remove the battery cover.
3. Replace 6 x "AA" batteries.
4. Secure the battery cover with the two (2) Phillips screws.

Applications

- OSHA work environment compliance
- Cinematography and photography applications
- Museum exhibits
- Lighting system installation
- Environmental monitoring
- Interior design projects
- Industrial applications

Accessories and Replacement Parts

R8100SD-PROBE Replacement Probe for R8100SD

R2920 Surface Thermocouple Probe

R2930 Right Angle Thermocouple Probe

R2940 Air/Gas Thermocouple Probe

R2950 Immersion Thermocouple Probe

R2960 Needle Tip Thermocouple Probe

TP-01 Beaded Thermocouple

R1500 Tripod

RSD-ADP-NA Power Supply, 110V

RSD-ADP-EU Power Supply, 220V

CA-05A Soft Carrying Case

R8888 Deluxe Hard Carrying Case

SD-4GB 4GB Class 4 SDHC Memory Card

RSD-16GB 16GB Micro SD Memory Card w/ Adapter

Don't see your part listed here? For a complete list of all accessories and replacement parts visit your product page on www.REEDInstruments.com.

Frequently Asked Questions (FAQ's)

I cannot turn off my meter, do you know why?

Often times, the meter cannot be turned off because it is in recording mode ("REC" mode). Make sure to exit that function by holding down the **REC** button before attempting to turn the meter off.

Can I set an alarm to go off at a specific temperature?

The meter does not have an alarm function.

continued...

REED Instruments

1-877-849-2127 | info@reedinstruments.com | www.reedinstruments.com

How long can I record for?

Battery life will depend on a number of factors:

- Quality of Battery
- Whether the beeper is ON or OFF
- Whether the backlight is ON or OFF
- Environmental Conditions during data logging

As a reference, using alkaline batteries with both the backlight and beeper on while automatic data logging at a 2 second sampling rate; the batteries lasted approx. 14 hours.

Does the R8100SD have a LED light mode?

Unfortunately R8100SD does not have an LED light mode capability. Kindly find the formula for LED lights for the REED R8100SD.

The reading value of the R8100SD multiplied by coefficient for LED light:

Coefficient:

LED white daylight: 0.99

LED RED light: 0.516

LED AMBER (YELLOW) light: 0.815

LED GREEN light: 1.216

LED BLUE light: 1.475

LED PURPLE light: 1.148

Product Care

To keep your instrument in good working order we recommend the following:

- Store your product in a clean, dry place.
- Change the battery as needed.
- If your instrument isn't being used for a period of one month or longer please remove the battery.
- Clean your product and accessories with biodegradable cleaner. Do not spray the cleaner directly on the instrument. Use on external parts only.

Product Warranty

REED Instruments guarantees this instrument to be free of defects in material or workmanship for a period of one (1) year from date of shipment. During the warranty period, REED Instruments will repair or replace, at no charge, products or parts of a product that proves to be defective because of improper material or workmanship, under normal use and maintenance. REED Instruments total liability is limited to repair or replacement of the product. REED Instruments shall not be liable for damages to goods, property, or persons due to improper use or through attempts to utilize the instrument under conditions which exceed the designed capabilities. In order to begin the warranty service process, please contact us by phone at 1-877-849-2127 or by email at info@REEDInstruments.com to discuss the claim and determine the appropriate steps to process the warranty.

Product Disposal and Recycling



Please follow local laws and regulations when disposing or recycling your instrument. Your product contains electronic components and must be disposed of separately from standard waste products.

Product Support

If you have any questions on your product, please contact your authorized REED distributor or REED Instruments Customer Service by phone at 1-877-849-2127 or by email at info@REEDInstruments.com.

Please visit www.REEDInstruments.com for the most up-to-date manuals, datasheets, product guides and software.

*Product specifications subject to change without notice.
All rights reserved. Any unauthorized copying or reproduction of this manual is strictly prohibited without prior written permission from REED Instruments.*

REED Instruments

1-877-849-2127 | info@reedinstruments.com | www.reedinstruments.com

REED INSTRUMENTS

TEST & MEASURE WITH CONFIDENCE



Over 200 portable test and
measurement instruments

Access our
Product Catalog



REED Instruments

1-877-849-2127 | info@reedinstruments.com | www.reedinstruments.com

REED INSTRUMENTS

TEMPERATURE
& HUMIDITY



SOUND



MOISTURE



AIR VELOCITY



ELECTRICAL



REED Instruments

1-877-849-2127 | info@reedinstruments.com | www.reedinstruments.com