



## GaAs PHEMT MMIC LOW NOISE AMPLIFIER, 2 - 4 GHz

### Typical Applications

The HMC594LC3B is ideal for:

- Fixed Microwave
- Point-to-Multi-Point Radios
- Test & Measurement Equipment
- Radar & Sensors
- Military & Space

### Features

- Gain Flatness:  $\pm 0.2$  dB
- Noise Figure: 3 dB
- Gain: 10 dB
- Output IP3: +36 dBm
- DC Supply: +5V @ 95mA / +6V @ 100 mA
- 50 Ohm Matched Input/Output
- RoHS Compliant 3x3 mm SMT package

### Functional Diagram

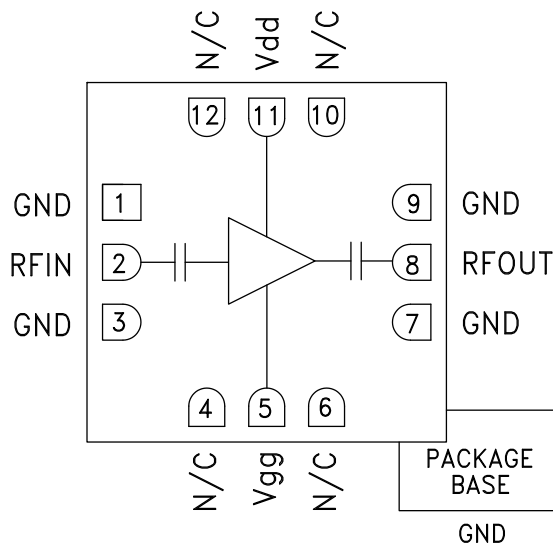

### General Description

The HMC594LC3B is a GaAs pHEMT MMIC Low Noise Amplifier (LNA) which operates from 2 to 4 GHz. The HMC594LC3B features extremely flat performance characteristics including 10 dB of small signal gain, 3 dB of noise figure and output IP3 of +36 dBm across the operating band. This high linearity LNA is ideal for test & measurement equipment and military assemblies due to its compact size, consistent output power and DC blocked RF I/O's. The HMC594LC3B is also available in chip form as the HMC594.

### Electrical Specifications, $T_A = +25^\circ\text{C}$ , $V_{dd} = +5\text{V}$ , $I_{dd} = 95\text{mA}$ , $V_{dd} = +6\text{V}$ , $I_{dd} = 100\text{mA}^*$

| Parameter                                | Min. | Typ.  | Max. | Units |
|--|------|-------|------|-------|
| Frequency Range                          |      | 2 - 4 |      | GHz   |
| Gain                                     | 7    | 10    |      | dB    |
| Gain Variation Over Temperature          |      | 0.015 |      | dB/°C |
| Noise Figure                             |      | 3     | 4    | dB    |
| Input Return Loss                        |      | 15    |      | dB    |
| Output Return Loss                       |      | 17    |      | dB    |
| Output Power for 1 dB Compression (P1dB) | 18   | 21    |      | dBm   |
| Saturated Output Power (Psat)            |      | 22    |      | dBm   |
| Output Third Order Intercept (IP3)       |      | 36    |      | dBm   |
| Supply Current (Idd)                     |      | 100   | 130  | mA    |

\*Adjust Vgg between -1.5V to -0.5V to achieve Idd = 100mA typical for 6V or Idd = 95mA typical for 5V.



**GaAs PHEMT MMIC LOW NOISE AMPLIFIER, 2 - 4 GHz**

**Broadband Gain & Return Loss [1]**

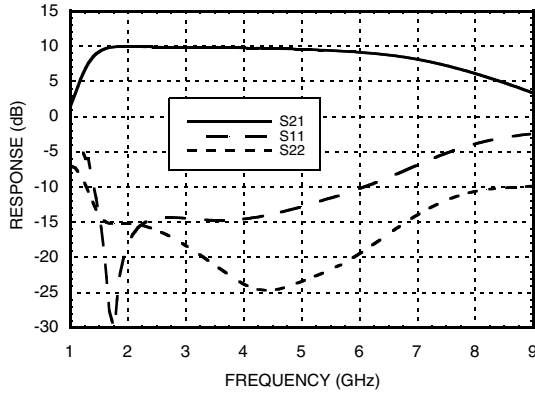

**Gain vs. Temperature [1]**

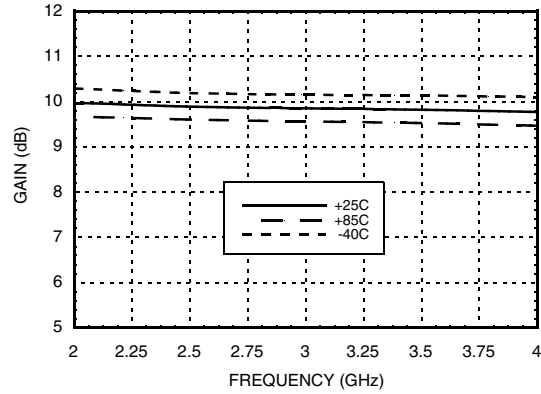

**Input Return Loss vs. Temperature [1]**

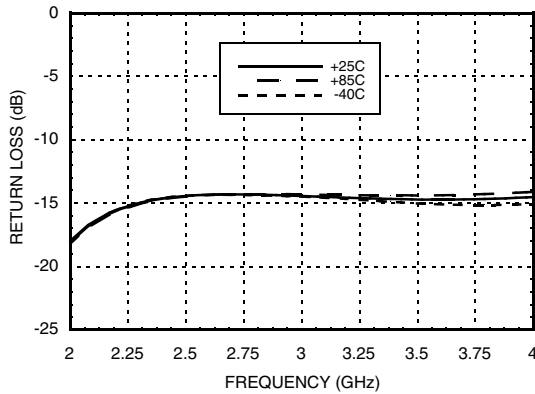

**Output Return Loss vs. Temperature [1]**

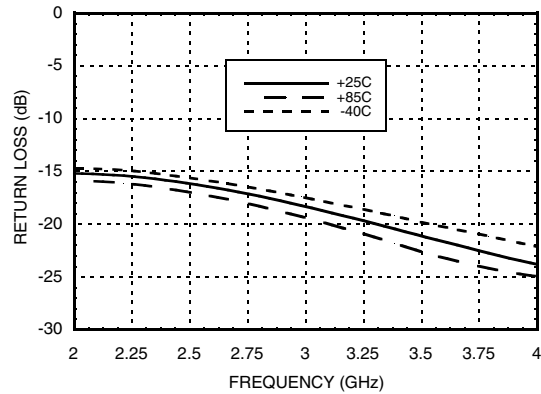

**P1dB vs. Temperature [1]**

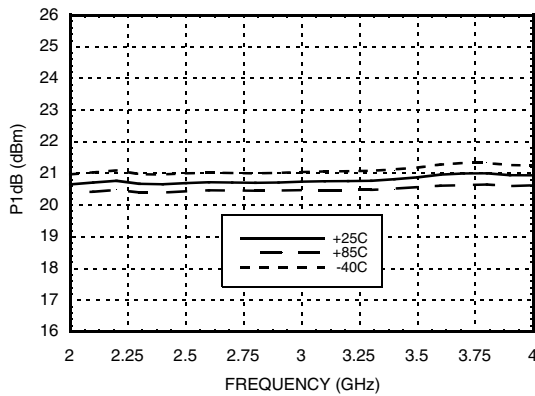

**Psat vs. Temperature [1]**

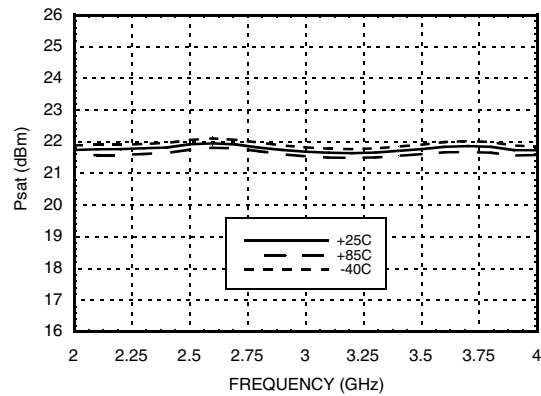

[1] Typical response for 5V and 6V Vdd



**GaAs PHEMT MMIC LOW NOISE AMPLIFIER, 2 - 4 GHz**

**Power Compression @ 3 GHz, 6V**

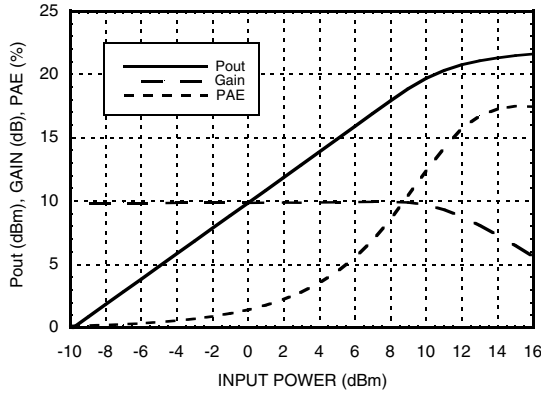

**Power Compression @ 3 GHz, 5V**

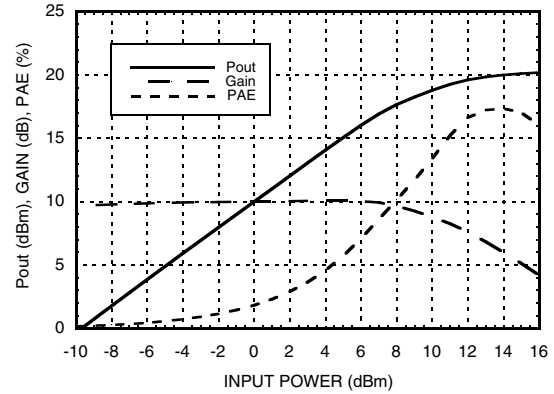

**Output IP3 vs. Temperature [1]**

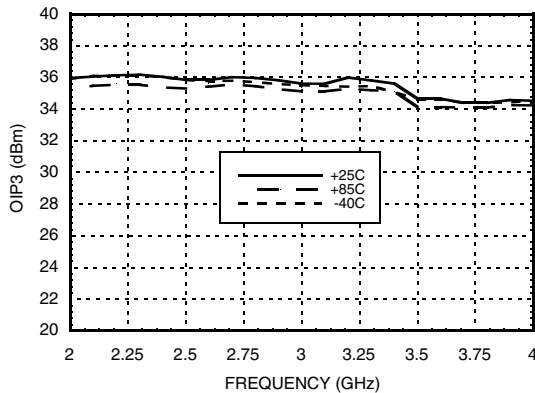

**Reverse Isolation vs. Temperature [1]**

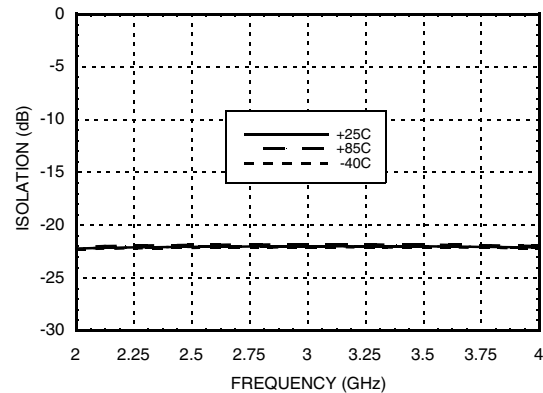

**Reverse Isolation vs. Temperature [1]**

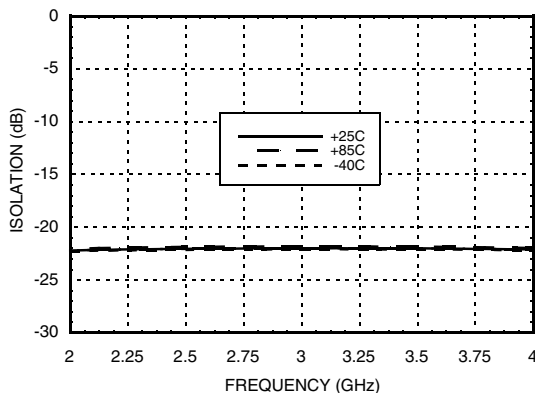

**Gain, Power & OIP3 vs. Supply Voltage @ 3 GHz**

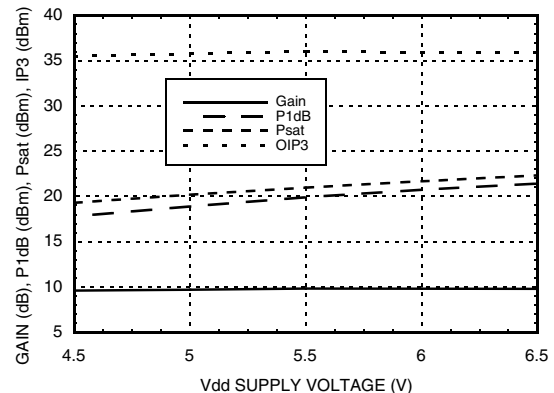

[1] Typical response for 5V and 6V Vdd

Information furnished by Analog Devices is believed to be accurate and reliable. However, no responsibility is assumed by Analog Devices for its use, nor for any infringements of patents or other rights of third parties that may result from its use. Specifications subject to change without notice. No license is granted by implication or otherwise under any patent or patent rights of Analog Devices. Trademarks and registered trademarks are the property of their respective owners.

For price, delivery, and to place orders: Analog Devices, Inc., One Technology Way, P.O. Box 9106, Norwood, MA 02062-9106 Phone: 781-329-4700 • Order online at [www.analog.com](http://www.analog.com) Application Support: Phone: 1-800-ANALOG-D



## GaAs PHEMT MMIC LOW NOISE AMPLIFIER, 2 - 4 GHz

### Absolute Maximum Ratings

|   |                |
|---|----------------|
| Drain Bias Voltage (Vdd)  | 7V             |
| RF Input Power (RFIN)(Vdd = +6V)  | +15 dBm        |
| Channel Temperature   | 175 °C         |
| Continuous P <sub>diss</sub> (T = 85 °C)<br>(derate 10 mW/°C above 85 °C) | 0.9 W          |
| Thermal Resistance<br>(channel to ground paddle)                          | 100 °C/W       |
| Storage Temperature   | -65 to +150 °C |
| Operating Temperature   | -40 to +85 °C  |

### Typical Supply Current vs. Vdd

| Vdd (V) | I <sub>dd</sub> (mA) |
|---------|----------------------|
| +5.5    | 97                   |
| +6.0    | 100                  |
| +6.5    | 103                  |

Note: Amplifier will operate over full voltage range shown above



ELECTROSTATIC SENSITIVE DEVICE  
OBSERVE HANDLING PRECAUTIONS

### Outline Drawing

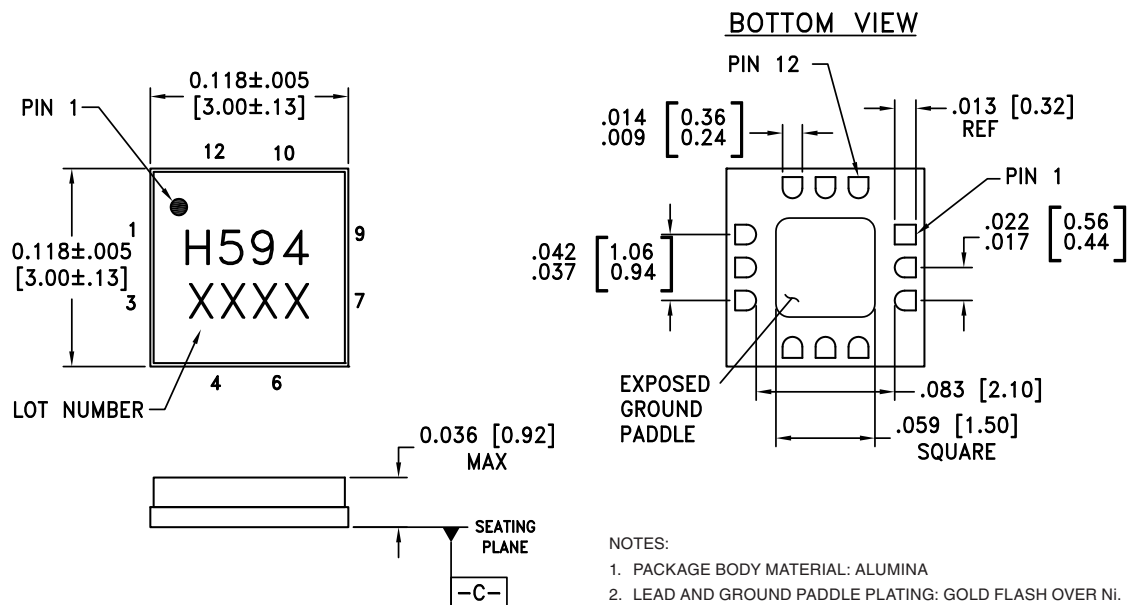

### Package Information

| Part Number | Package Body Material | Lead Finish      | MSL Rating | Package Marking [2] |
|-------------|-----------------------|------------------|------------|---------------------|
| HMC594LC3B  | Alumina, White        | Gold over Nickel | MSL3 [1]   | H594<br>XXXX        |

[1] Max peak reflow temperature of 260 °C

[2] 4-Digit lot number XXXX



**GaAs PHEMT MMIC LOW NOISE AMPLIFIER, 2 - 4 GHz**

**Pin Descriptions**

| Pin Number     | Function | Description  | Interface Schematic |
|----------------|----------|--|---------------------|
| 1, 3, 7, 9     | GND      | Package bottom must also be connected to RF/DC ground  |                     |
| 2              | RFIN     | This pin is AC coupled and matched to 50 Ohms.   |                     |
| 4, 6<br>10, 12 | N/C      | The pins are not connected internally; however, all data shown herein was measured with these pins connected to RF/DC ground externally. |                     |
| 5              | Vgg      | Gate supply voltage for the amplifier. Adjust to achieve I <sub>dd</sub> = 100mA. External bypass capacitors are required.               |                     |
| 8              | RFOUT    | This pin is AC coupled and matched to 50 Ohms.   |                     |
| 11             | Vdd      | Power Supply Voltage for the amplifier. External bypass capacitors are required.   |                     |

**Application Circuit**

| Component | Value    |
|-----------|----------|
| C1, C4    | 100 pF   |
| C2, C5    | 1,000 pF |
| C3, C6    | 2.2 μF   |

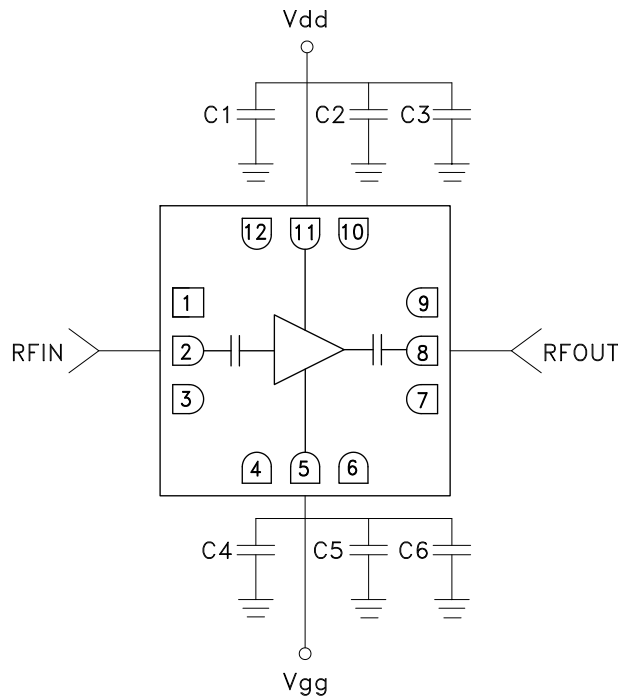

Information furnished by Analog Devices is believed to be accurate and reliable. However, no responsibility is assumed by Analog Devices for its use, nor for any infringements of patents or other rights of third parties that may result from its use. Specifications subject to change without notice. No license is granted by implication or otherwise under any patent or patent rights of Analog Devices. Trademarks and registered trademarks are the property of their respective owners.

For price, delivery, and to place orders: Analog Devices, Inc., One Technology Way, P.O. Box 9106, Norwood, MA 02062-9106 Phone: 781-329-4700 • Order online at [www.analog.com](http://www.analog.com) Application Support: Phone: 1-800-ANALOG-D

**GaAs PHEMT MMIC LOW NOISE AMPLIFIER, 2 - 4 GHz**



**Evaluation PCB**

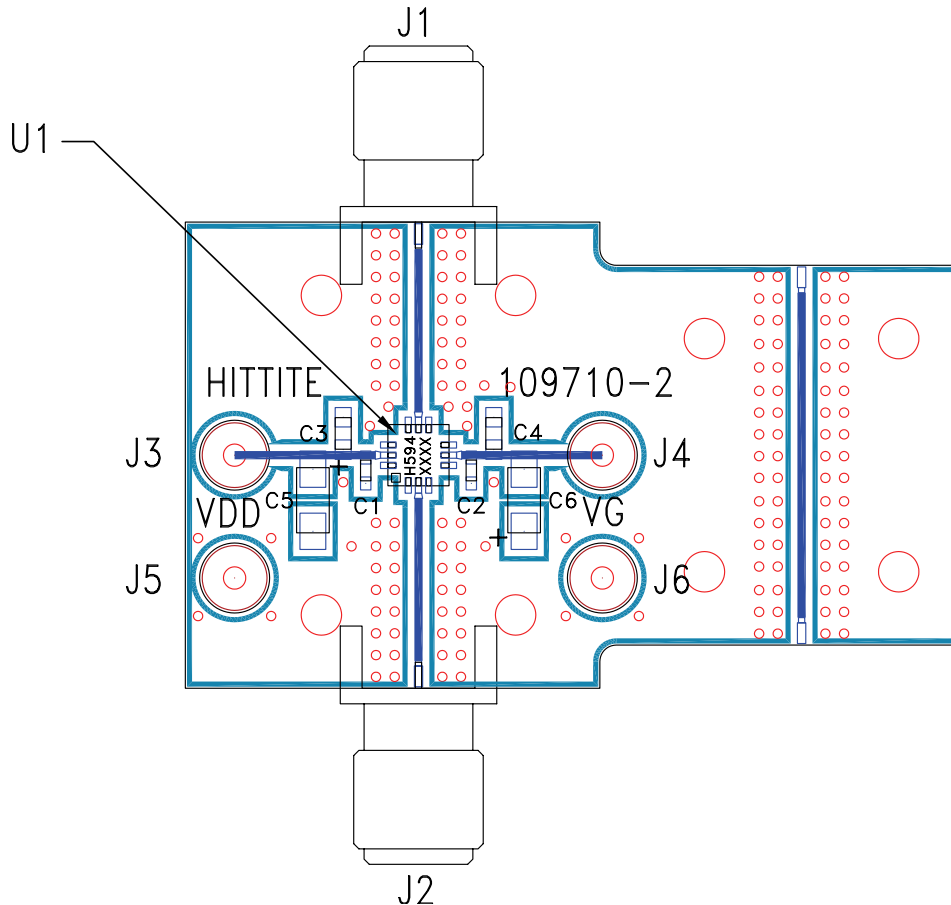

**List of Materials for Evaluation PCB 109712 [1]**

| Item    | Description                    |
|---------|--------------------------------|
| J1 - J2 | SRI SMA Connector              |
| J3 - J6 | DC Pin                         |
| C1 - C2 | 100 pF Capacitor, 0402 Pkg.    |
| C3 - C4 | 1000 pF Capacitor, 0603 Pkg.   |
| C5 - C6 | 2.2 μF Capacitor, Tantalum     |
| U1      | HMC594LC3B Amplifier           |
| PCB [2] | 109710 Evaluation PCB, 10 mils |

[1] Reference this number when ordering complete evaluation PCB

[2] Circuit Board Material: Rogers 4350

The circuit board used in the application should use RF circuit design techniques. Signal lines should have 50 Ohm impedance while the package ground leads and exposed paddle should be connected directly to the ground plane similar to that shown. A sufficient number of via holes should be used to connect the top and bottom ground planes. The evaluation board should be mounted to an appropriate heat sink. The evaluation circuit board shown is available from Hittite upon request.