

- Advanced Process Technology
- Ultra Low On-Resistance
- Dynamic dv/dt Rating
- 175°C Operating Temperature
- Fast Switching
- Fully Avalanche Rated
- Lead-Free

IRFR3411PbF

IRFU3411PbF

HEXFET® Power MOSFET

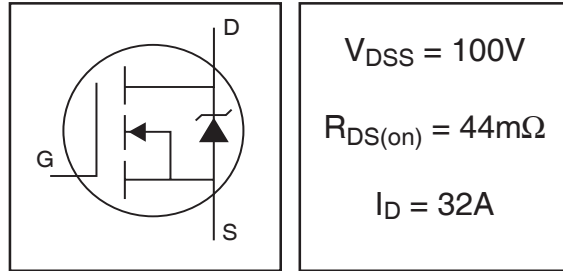

Description

Advanced HEXFET® Power MOSFETs from International Rectifier utilize advanced processing techniques to achieve extremely low on-resistance per silicon area. This benefit, combined with the fast switching speed and ruggedized device design that HEXFET power MOSFETs are well known for, provides the designer with an extremely efficient and reliable device for use in a wide variety of applications.

The D-Pak is designed for surface mounting using vapor phase, infrared, or wave soldering techniques. The straight lead, I-Pak, version (IRFU series) is for through-hole mounting applications. Power dissipation levels up to 1.5 watts are possible in typical surface mount applications.

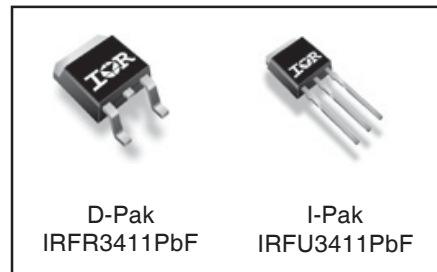

Absolute Maximum Ratings

| | Parameter | Max. | Units |
|---------------------------------|---|--------------|-------|
| $I_D @ T_C = 25^\circ\text{C}$ | Continuous Drain Current, $V_{GS} @ 10\text{V}$ | 32 | A |
| $I_D @ T_C = 100^\circ\text{C}$ | Continuous Drain Current, $V_{GS} @ 10\text{V}$ | 23 | |
| I_{DM} | Pulsed Drain Current ① | 110 | |
| $P_D @ T_C = 25^\circ\text{C}$ | Power Dissipation | 130 | W |
| | Linear Derating Factor | 0.83 | W/°C |
| V_{GS} | Gate-to-Source Voltage | ± 20 | V |
| I_{AR} | Avalanche Current ① | 16 | A |
| E_{AR} | Repetitive Avalanche Energy ① | 13 | mJ |
| dv/dt | Peak Diode Recovery dv/dt ③ | 7.0 | V/ns |
| T_J | Operating Junction and | -55 to + 175 | °C |
| T_{STG} | Storage Temperature Range | | |
| | Soldering Temperature, for 10 seconds | | |

Thermal Resistance

| | Parameter | Typ. | Max. | Units |
|-----------------|----------------------------------|------|------|-------|
| $R_{\theta JC}$ | Junction-to-Case | — | 1.2 | °C/W |
| $R_{\theta JA}$ | Junction-to-Ambient (PCB mount)* | — | 50 | |
| $R_{\theta JA}$ | Junction-to-Ambient | — | 110 | |

Electrical Characteristics @ T_J = 25°C (unless otherwise specified)

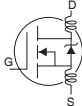
| | Parameter | Min. | Typ. | Max. | Units | Conditions |
|--|--------------------------------------|------|------|------|-------|--|
| V _{(BR)DSS} | Drain-to-Source Breakdown Voltage | 100 | — | — | V | V _{GS} = 0V, I _D = 250μA |
| ΔV _{(BR)DSS} /ΔT _J | Breakdown Voltage Temp. Coefficient | — | 0.12 | — | V/°C | Reference to 25°C, I _D = 1mA |
| R _{DS(on)} | Static Drain-to-Source On-Resistance | — | 36 | 44 | mΩ | V _{GS} = 10V, I _D = 16A ④ |
| V _{GS(th)} | Gate Threshold Voltage | 2.0 | — | 4.0 | V | V _{DS} = V _{GS} , I _D = 250μA |
| g _{fs} | Forward Transconductance | 21 | — | — | S | V _{DS} = 50V, I _D = 16A④ |
| I _{DSS} | Drain-to-Source Leakage Current | — | — | 25 | μA | V _{DS} = 100V, V _{GS} = 0V |
| | | — | — | 250 | | V _{DS} = 80V, V _{GS} = 0V, T _J = 150°C |
| I _{GSS} | Gate-to-Source Forward Leakage | — | — | 100 | nA | V _{GS} = 20V |
| | Gate-to-Source Reverse Leakage | — | — | -100 | | V _{GS} = -20V |
| Q _g | Total Gate Charge | — | 48 | 71 | nC | I _D = 16A |
| Q _{gs} | Gate-to-Source Charge | — | 9.0 | 14 | | V _{DS} = 80V |
| Q _{gd} | Gate-to-Drain ("Miller") Charge | — | 14 | 21 | | V _{GS} = 10V, See Fig. 6 and 13 |
| t _{d(on)} | Turn-On Delay Time | — | 11 | — | ns | V _{DD} = 50V |
| t _r | Rise Time | — | 35 | — | | I _D = 16A |
| t _{d(off)} | Turn-Off Delay Time | — | 39 | — | | R _G = 5.1Ω |
| t _f | Fall Time | — | 35 | — | | V _{GS} = 10V, See Fig. 10 ④ |
| L _D | Internal Drain Inductance | — | 4.5 | — | nH | Between lead, 6mm (0.25in.) from package and center of die contact |
| L _S | Internal Source Inductance | — | 7.5 | — | |  |
| C _{iss} | Input Capacitance | — | 1960 | — | pF | V _{GS} = 0V |
| C _{oss} | Output Capacitance | — | 250 | — | | V _{DS} = 25V |
| C _{rss} | Reverse Transfer Capacitance | — | 40 | — | | f = 1.0MHz, See Fig. 5 |
| E _{AS} | Single Pulse Avalanche Energy② | — | 700③ | 185⑥ | | I _{AS} = 16A, L = 1.5mH |

Source-Drain Ratings and Characteristics

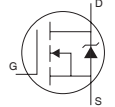
| | Parameter | Min. | Typ. | Max. | Units | Conditions |
|-----------------|---|--|------|------|-------|--|
| I _S | Continuous Source Current (Body Diode) | — | — | 33 | A | MOSFET symbol showing the integral reverse p-n junction diode.  |
| I _{SM} | Pulsed Source Current (Body Diode)① | — | — | 110 | | |
| V _{SD} | Diode Forward Voltage | — | — | 1.2 | V | T _J = 25°C, I _S = 16A, V _{GS} = 0V ④ |
| t _{rr} | Reverse Recovery Time | — | 115 | 170 | ns | T _J = 25°C, I _F = 16A |
| Q _{rr} | Reverse Recovery Charge | — | 505 | 760 | nC | di/dt = 100A/μs ④ |
| t _{on} | Forward Turn-On Time | Intrinsic turn-on time is negligible (turn-on is dominated by L _S +L _D) | | | | |

Notes:

- ① Repetitive rating; pulse width limited by max. junction temperature. (See fig. 11)
- ② Starting T_J = 25°C, L = 1.5mH
R_G = 25Ω, I_{AS} = 16A. (See Figure 12)
- ③ I_{SD} ≤ 16A, di/dt ≤ 340A/μs, V_{DD} ≤ V_{(BR)DSS},
T_J ≤ 175°C.
- ④ Pulse width ≤ 400μs; duty cycle ≤ 2%.

⑤ This is a typical value at device destruction and represents operation outside rated limits.

⑥ This is a calculated value limited to T_J = 175°C .

* When mounted on 1" square PCB (FR-4 or G-10 Material). For recommended footprint dering techniques refer to application note #AN-994.

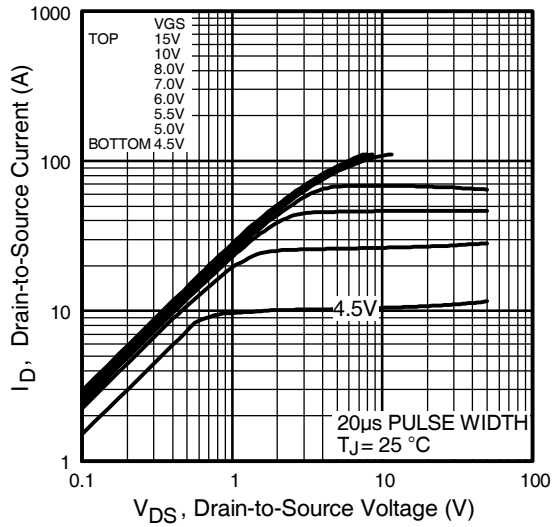

Fig 1. Typical Output Characteristics

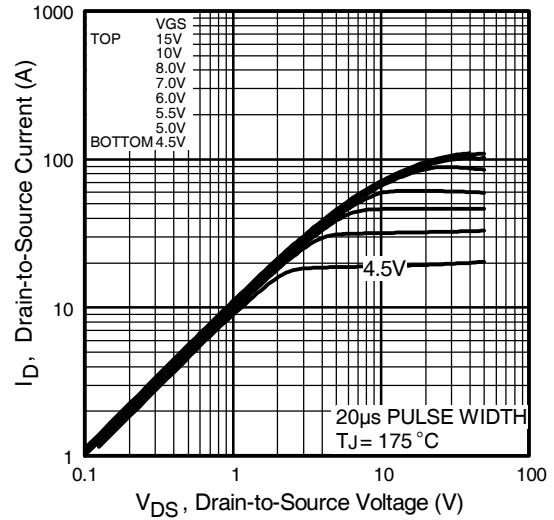

Fig 2. Typical Output Characteristics

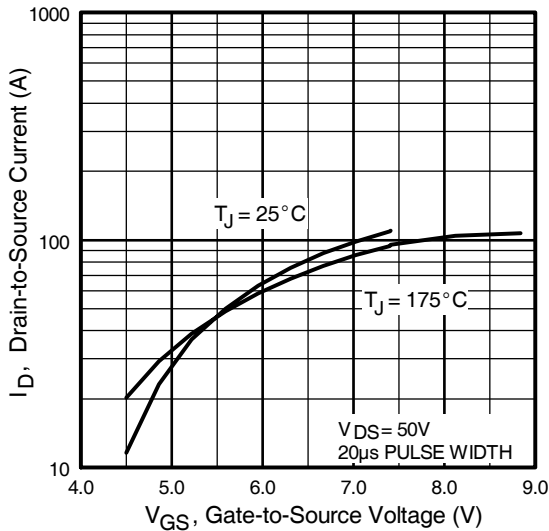

Fig 3. Typical Transfer Characteristics

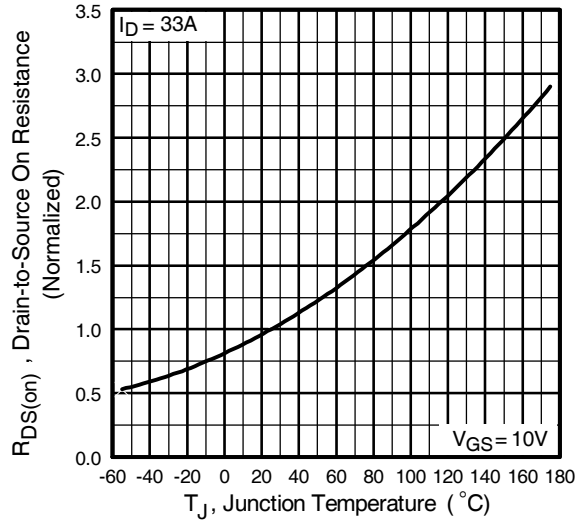

Fig 4. Normalized On-Resistance Vs. Temperature

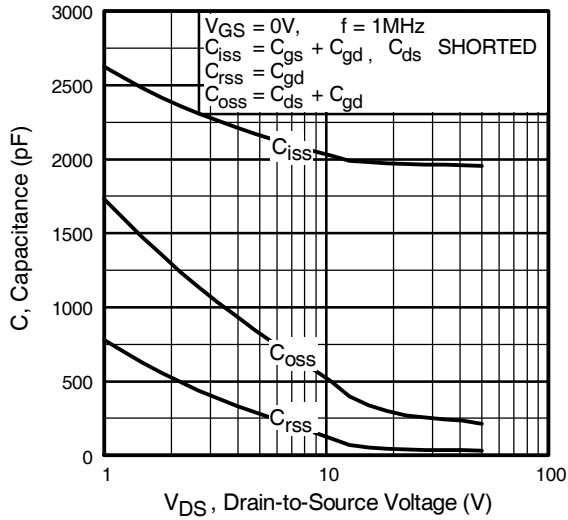

Fig 5. Typical Capacitance Vs. Drain-to-Source Voltage

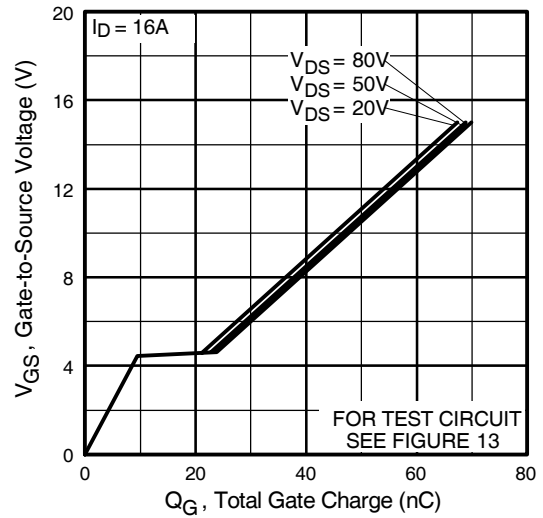

Fig 6. Typical Gate Charge Vs. Gate-to-Source Voltage

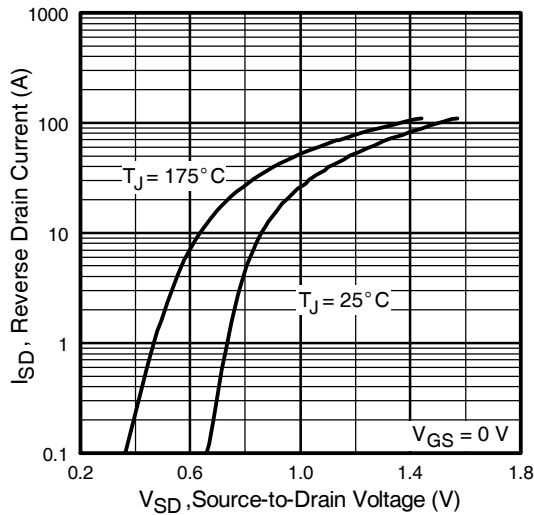

Fig 7. Typical Source-Drain Diode Forward Voltage

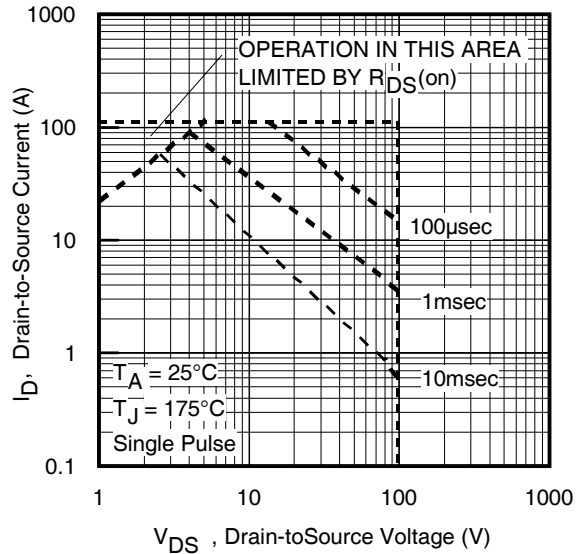

Fig 8. Maximum Safe Operating Area

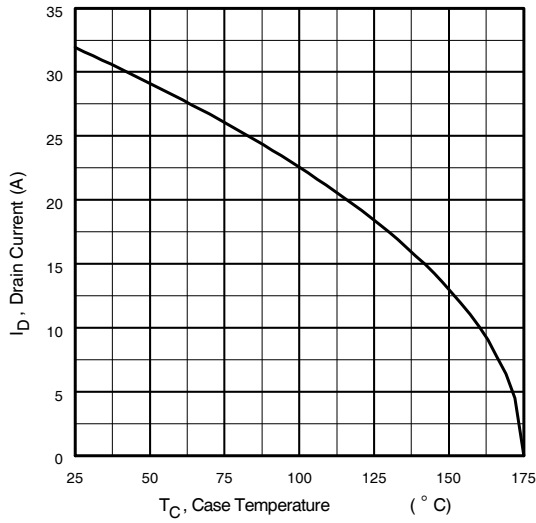

Fig 9. Maximum Drain Current Vs. Case Temperature



Fig 10a. Switching Time Test Circuit



Fig 10b. Switching Time Waveforms

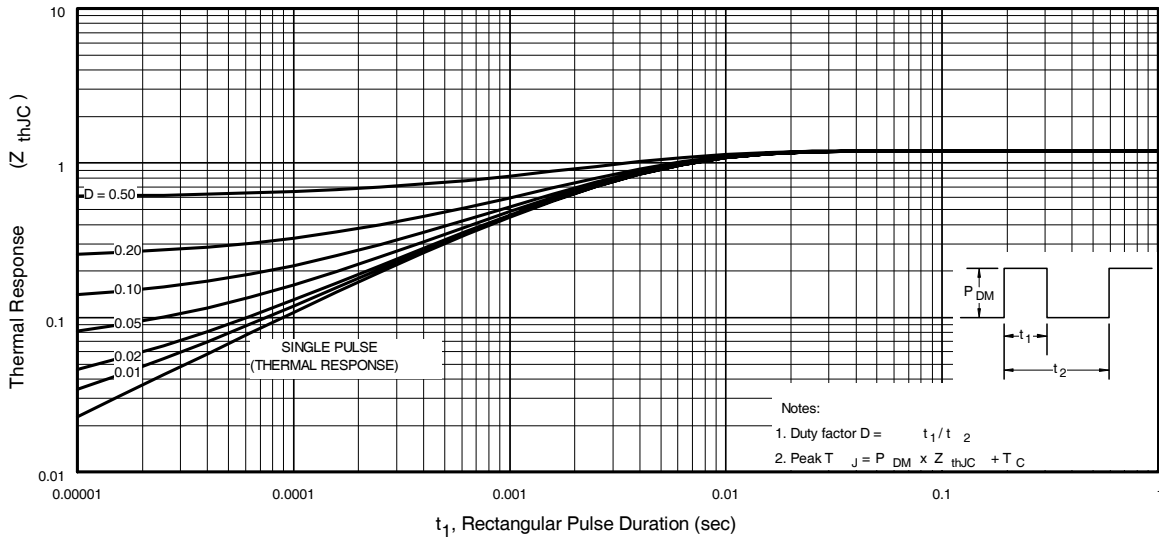

Fig 11. Maximum Effective Transient Thermal Impedance, Junction-to-Case

IRFR/U3411PbF

International
IR Rectifier

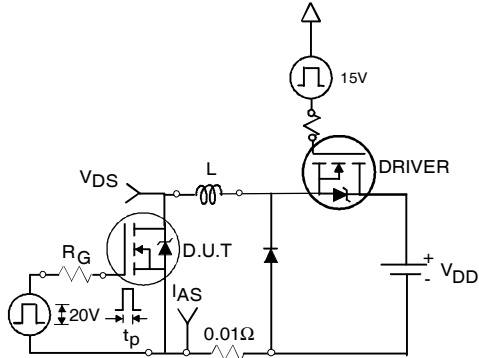

Fig 12a. Unclamped Inductive Test Circuit

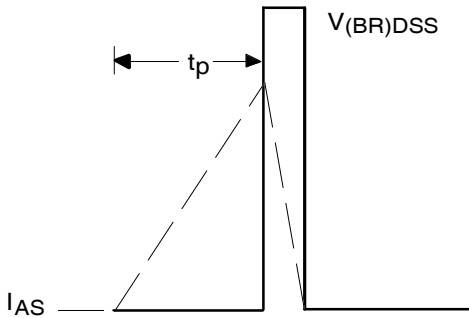

Fig 12b. Unclamped Inductive Waveforms

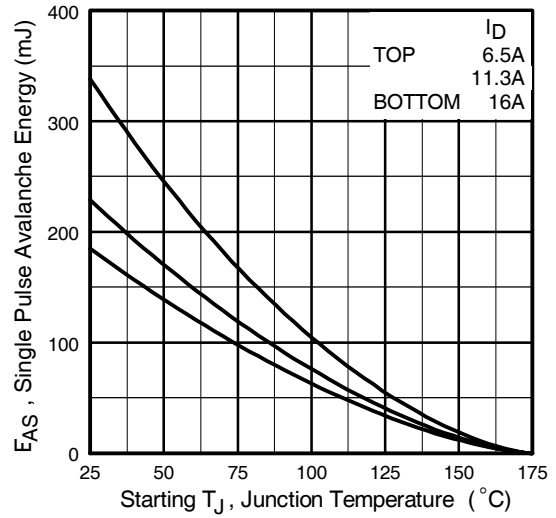

Fig 12c. Maximum Avalanche Energy Vs. Drain Current

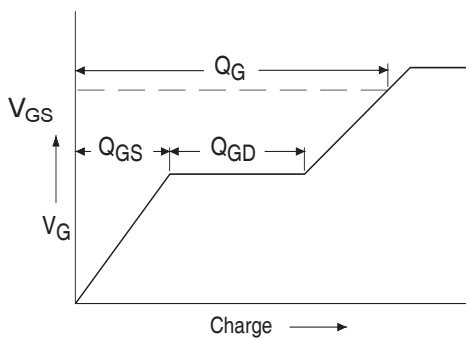

Fig 13a. Basic Gate Charge Waveform

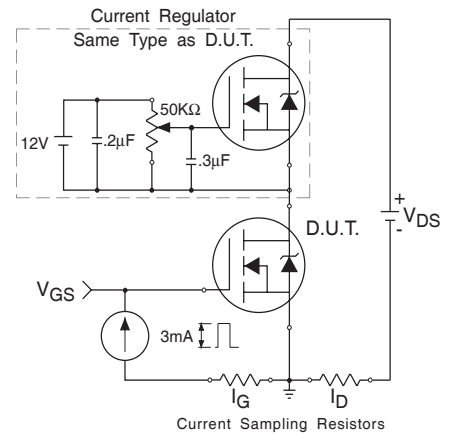

Fig 13b. Gate Charge Test Circuit

Peak Diode Recovery dv/dt Test Circuit



* Reverse Polarity of D.U.T for P-Channel



*** $V_{GS} = 5.0V$ for Logic Level and 3V Drive Devices

Fig 14. For N-channel HEXFET[®] power MOSFETs

IRFR/U3411PbF

International
IR Rectifier

D-Pak (TO-252AA) Package Outline

Dimensions are shown in millimeters (inches)

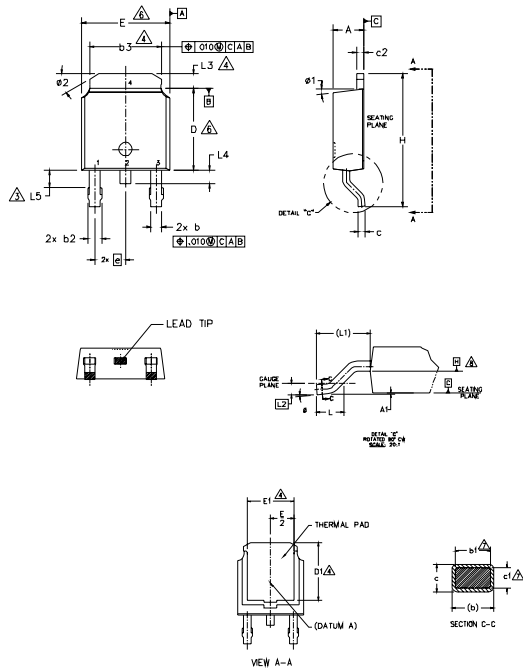

- NOTES:
- 1.- DIMENSIONING AND TOLERANCING PER ASME Y14.5M-1994
 - 2.- DIMENSIONS ARE SHOWN IN INCHES (MILLIMETERS).
 - 3.- LEAD DIMENSION UNCONTROLLED IN L5.
 - 4.- DIMENSION D1, E1, L3 & b3 ESTABLISH A MINIMUM MOUNTING SURFACE FOR THERMAL PAD.
 - 5.- SECTION C-C DIMENSIONS APPLY TO THE FLAT SECTION OF THE LEAD BETWEEN .005 AND 0.10 [0.13 AND 0.25] FROM THE LEAD TIP.
 - 6.- DIMENSION D & E DO NOT INCLUDE MOLD FLASH. MOLD FLASH SHALL NOT EXCEED .005 [0.13] PER SIDE. THESE DIMENSIONS ARE MEASURED AT THE OUTMOST EXTREMES OF THE PLASTIC BODY.
 - 7.- DIMENSION b1 & c1 APPLIED TO BASE METAL ONLY.
 - 8.- DATUM A & B TO BE DETERMINED AT DATUM PLANE H.
 - 9.- OUTLINE CONFORMS TO JEDEC OUTLINE TO-252AA.

| SYMBOL | DIMENSIONS | | | | NOTES |
|--------|-------------|-------|-----------|------|-------|
| | MILLIMETERS | | INCHES | | |
| | MIN. | MAX. | MIN. | MAX. | |
| A | 2.18 | 2.39 | .086 | .094 | |
| A1 | - | 0.13 | - | .005 | |
| b | 0.64 | 0.89 | .025 | .035 | 7 |
| b1 | 0.65 | 0.79 | .025 | .031 | |
| b2 | 0.76 | 1.14 | .030 | .045 | |
| b3 | 4.95 | 5.46 | .195 | .215 | 4 |
| c | 0.46 | 0.61 | .018 | .024 | |
| c1 | 0.41 | 0.56 | .016 | .022 | 7 |
| c2 | 0.46 | 0.89 | .018 | .035 | |
| D | 5.97 | 6.22 | .235 | .245 | 6 |
| D1 | 5.21 | - | .205 | - | 4 |
| E | 6.35 | 6.73 | .250 | .265 | 6 |
| E1 | 4.32 | - | .170 | - | 4 |
| e | 2.29 BSC | | .090 BSC | | |
| H | 9.40 | 10.41 | .370 | .410 | |
| L | 1.40 | 1.78 | .055 | .070 | |
| L1 | 2.74 BSC | | .108 REF. | | |
| L2 | 0.51 BSC | | .020 BSC | | |
| L3 | 0.89 | 1.27 | .035 | .050 | 4 |
| L4 | - | 1.02 | - | .040 | |
| L5 | 1.14 | 1.52 | .045 | .060 | 3 |
| e | 0° | 10° | 0° | 10° | |
| ø1 | 0° | 15° | 0° | 15° | |
| ø2 | 25° | 35° | 25° | 35° | |

LEAD ASSIGNMENTS

HEXFEE T

- 1.- GATE
- 2.- DRAIN
- 3.- SOURCE
- 4.- DRAIN

IGBT & CoPAK

- 1.- GATE
- 2.- COLLECTOR
- 3.- EMITTER
- 4.- COLLECTOR

D-Pak (TO-252AA) Part Marking Information

EXAMPLE: THIS IS AN IRFR120 WITH ASSEMBLY LOT CODE 1234 ASSEMBLED ON WW 16, 2001 IN THE ASSEMBLY LINE "A"

Note: "P" in assembly line position indicates "Lead-Free"

"P̄" in assembly line position indicates "Lead-Free" qualification to the consumer level



INTERNATIONAL RECTIFIER LOGO

ASSEMBLY LOT CODE

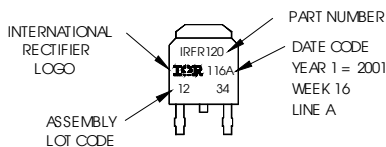

PART NUMBER

DATE CODE
P = DESIGNATES LEAD-FREE PRODUCT (OPTIONAL)

P̄ = DESIGNATES LEAD-FREE PRODUCT QUALIFIED TO THE CONSUMER LEVEL (OPTIONAL)

YEAR 1 = 2001
WEEK 16

A = ASSEMBLY SITE CODE

Notes:

1. For an Automotive Qualified version of this part please see <http://www.irf.com/product-info/auto/>
2. For the most current drawing please refer to IR website at <http://www.irf.com/package/>

I-Pak (TO-251AA) Package Outline

Dimensions are shown in millimeters (inches)

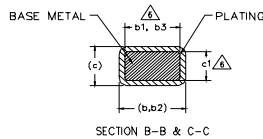
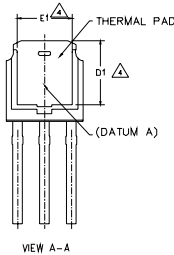
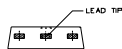
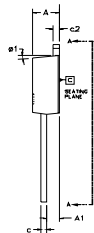
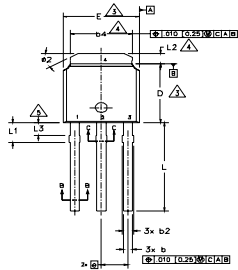

- NOTES:
- 1.- DIMENSIONING AND TOLERANCING PER ASME Y14.5M-1994
 - 2.- DIMENSIONS ARE SHOWN IN INCHES [MILLIMETERS]
 - 3.- DIMENSION D & E DO NOT INCLUDE MOLD FLASH. MOLD FLASH SHALL NOT EXCEED .005 [0.13] PER SIDE. THESE DIMENSIONS ARE MEASURED AT THE OUTMOST EXTREMES OF THE PLASTIC BODY.
 - 4.- THERMAL PAD CONTOUR OPTION WITHIN DIMENSION b4, L2, E1 & D1.
 - 5.- LEAD DIMENSION UNCONTROLLED IN L3.
 - 6.- DIMENSION b1, b3 & c1 APPLY TO BASE METAL ONLY.
 - 7.- OUTLINE CONFORMS TO JEDEC OUTLINE TO-251AA (Date 06/02).
 - 8.- CONTROLLING DIMENSION : INCHES.

| SYMBOL | DIMENSIONS | | | | NOTES |
|--------|-------------|------|----------|------|-------|
| | MILLIMETERS | | INCHES | | |
| | MIN. | MAX. | MIN. | MAX. | |
| A | 2.18 | 2.59 | .086 | .094 | |
| A1 | 0.89 | 1.14 | .035 | .045 | |
| b | 0.64 | 0.89 | .025 | .035 | |
| b1 | 0.65 | 0.79 | .025 | .031 | 6 |
| b2 | 0.76 | 1.14 | .030 | .045 | |
| b3 | 0.76 | 1.04 | .030 | .041 | 6 |
| b4 | 4.95 | 5.46 | .195 | .215 | 4 |
| c | 0.46 | 0.61 | .018 | .024 | |
| c1 | 0.41 | 0.56 | .016 | .022 | 6 |
| c2 | 0.46 | 0.89 | .018 | .035 | |
| D | 5.97 | 6.22 | .235 | .245 | 3 |
| D1 | 5.21 | - | .205 | - | 4 |
| E | 6.35 | 6.73 | .250 | .265 | 3 |
| E1 | 4.32 | - | .170 | - | 4 |
| e | 2.29 BSC | | .090 BSC | | |
| L | 8.89 | 9.65 | .350 | .380 | |
| L1 | 1.91 | 2.29 | .045 | .090 | |
| L2 | 0.89 | 1.27 | .035 | .050 | 4 |
| L3 | 1.14 | 1.52 | .045 | .060 | 5 |
| ø1 | 0" | 15" | 0" | 15" | |
| ø2 | 25" | 35" | 25" | 35" | |

LEAD ASSIGNMENTS

- HEXFET
- 1.- GATE
 - 2.- DRAIN
 - 3.- SOURCE
 - 4.- DRAIN

I-Pak (TO-251AA) Part Marking Information

EXAMPLE: THIS IS AN IRFU120 WITH ASSEMBLY LOT CCDE 5678 ASSEMBLED ON WW 19, 2001 IN THE ASSEMBLY LINE "A"

Note: "P" in assembly line position indicates Lead-Free!

OR

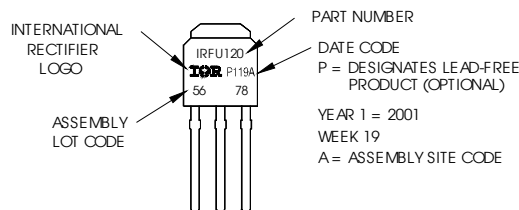
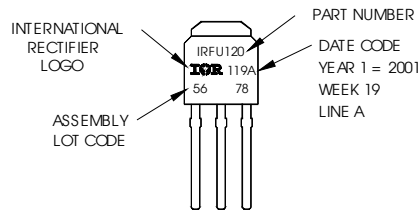

Notes:

1. For an Automotive Qualified version of this part please see <http://www.irf.com/product-info/autof/>
2. For the most current drawing please refer to IR website at <http://www.irf.com/package/>

IRFR/U3411PbF

International
IR Rectifier

D-Pak (TO-252AA) Tape & Reel Information

Dimensions are shown in millimeters (inches)

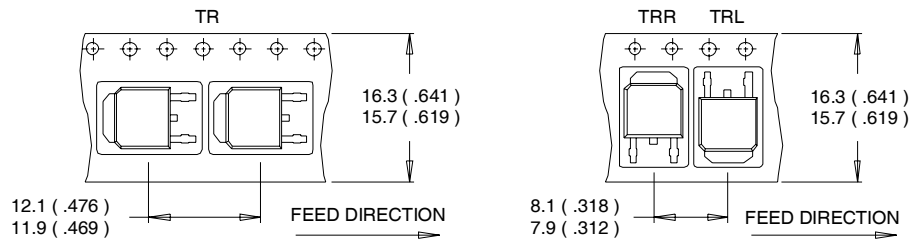

NOTES :

1. CONTROLLING DIMENSION : MILLIMETER.
2. ALL DIMENSIONS ARE SHOWN IN MILLIMETERS (INCHES).
3. OUTLINE CONFORMS TO EIA-481 & EIA-541.

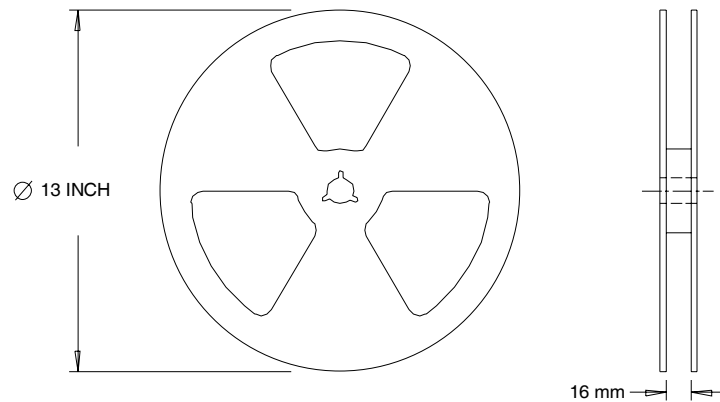

NOTES :

1. OUTLINE CONFORMS TO EIA-481.

Data and specifications subject to change without notice.
This product has been designed and qualified for the Industrial market.
Qualification Standards can be found on IR's Web site.

International
IR Rectifier

IR WORLD HEADQUARTERS: 233 Kansas St., El Segundo, California 90245, USA Tel: (310) 252-7105
TAC Fax: (310) 252-7903

Visit us at www.irf.com for sales contact information.09/2010

www.irf.com