

**SHORT FORM
SENSORS**



A new performance class of innovative sensor technology

■ The delivery program: Innovative and extensive.

Besides through-beam and retroreflective types, reflective sensors and optical fiber photoelectric sensors, we also offer laser and eddy current analog sensors that provide precise measurement results even in the most complicated of applications. Our delivery program also includes safety sensors, photoelectric sensors for special applications, inductive proximity switches and miniature pressure sensors for relative or differential pressure measurement, and ionizers for Electro Static Discharge applications.



■ Service has priority.

We are constantly striving to optimize our service sector to enable us to react quickly to customer requests. Whether you have specific application requests or you simply want technical information, we are always ready to advise and assist you; you only have to call.

Our current delivery program is assembled for you in this sensor overview. Besides the most important technical data, you will find numerous illustrations of possible applications. Of course, detailed data sheets are available on our homepage www.panasonic-electric-works.com. Our product managers, sales and application engineers will be happy to advise you.



www.panasonic-electric-works.com

	Page		Page
	Fiber Optic Sensors 4		Trigonometric Sensors 88
	FX-100..... 4		EQ-500 88
	FX-301..... 6		EQ-30 90
	FX-311..... 8		MQ-W 91
	FX-500..... 9		
	Fiber Sensors Communication Units 24		Safety Sensors..... 92
	FX-CH2..... 24		ST4..... 92
	SC-GU1-485..... 26		SF2B..... 94
			SF4B<V2> 95
			SF4C 97
			SD3-A1 101
			SF-C10 103
	Optical Fiber Heads..... 28		
	FT/FD-W..... 28		Pressure & Flow Sensors 104
	FT-WA30/A30, FT-WA8/A8, FD-A15 28		FM-200 104
	FD-H30-L32 / FD-H18-L31 29		DP-100 106
	FD-H20-21 / FD-H35-20S..... 29		DPH-100/ DPC-100..... 108
	FR-KZ21/KZ21E..... 30		DP2..... 110
	FR-WKZ11 30		DP4..... 112
	FD-G6..... 31		DP5/DPH..... 114
	FD-WKZ1..... 31		Pressure & Flow Sensors 116
			DP-M 116
	Standard Fibers 32		CC Link Network Solutions 118
			CC Link..... 118
	Sensors for Semiconductor/ FPD Industry 46		Inductive Proximity Sensors 120
	FD-L40..... 46		GX-F/H 120
	FT/FD-V..... 47		GX-S..... 122
	EX-F70/F60 48		
	FR-KV1..... 49		Measurement Sensors 124
			GP-X..... 124
	Fiber Heads 50		HL-G1 125
	FD-F705 50		LM-10 127
	FT-F902..... 51		HL-C1 129
			HL-C135C-BK10..... 131
	Laser Sensors..... 52		HL-C1C-M-WL..... 131
	M18-L 52		HL-C2 132
	LC-100..... 54		Ionizers 136
	LC-120..... 56		ER-F Series..... 136
	EX-L200..... 58		ER-TF 138
	LS 60		ER-VW..... 140
			ER-V 142
	Mark Sensors..... 62		EC-G..... 144
	LX-100..... 62		Electrostatic Sensors..... 146
			EF-S1 146
	Photoelectronic Sensors 64		
	CX-400 64		
	NX5..... 68		
	CY..... 70		
	M18..... 72		
	EX-10..... 73		
	EX-20..... 75		
	EX-30..... 77		
	PM 79		
	PM2 83		
	NA1-11..... 85		
	NA1-PK5/ NA1-PK3 86		

FX-100



FX-100

Excellent price/performance ratio

Features

■ Easy to read

The digital dual-display allows you to check both the threshold value and incident light intensity at the same time, and it also makes the procedures for setting the various values much easier.

■ Multipurpose, M8 connector type

The connectors used are commercially-available M8 connectors, so that processing costs and lead time required for carrying out processing after purchase of the sensors can be greatly reduced.

■ Designed in a 3-layer structure to accommodate basic settings through to advanced settings.

Setting details are divided into three levels for clearer operation, so that setting for normal operation are made in 'RUN mode', basic settings are made in 'SET mode', and advanced functions are set in 'PRO mode'. This makes setting operations much easier to understand and carry out.

Typical Applications

■ Wafer detection

FD-WKZ + FX 10□

Detects wafer carrier cases through vacuum chamber's view port.

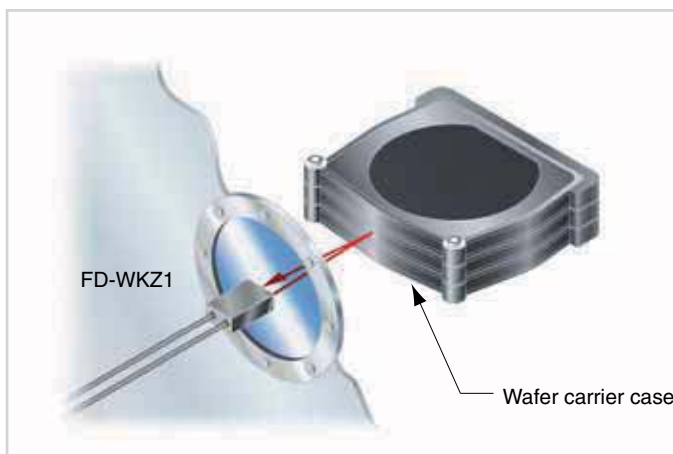

■ Wafer detection

FT-L80Y + FX10□

Sensing possible in corrosive environment. Lenses at the ends of the fiber heads expand the sensing range.

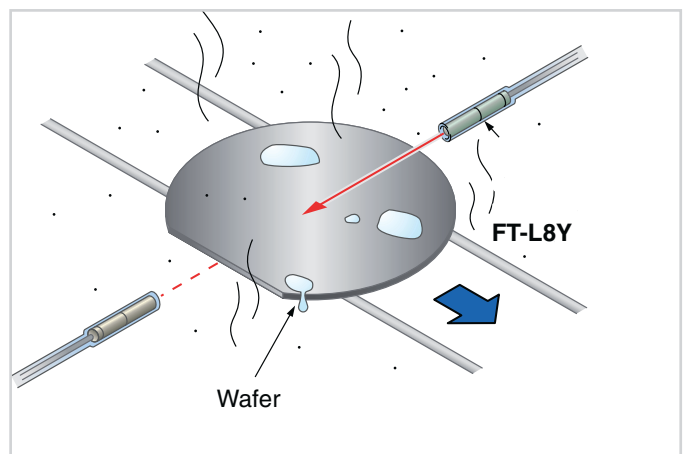

Detection of break / crack of glass

FV-SV2 + FX10□

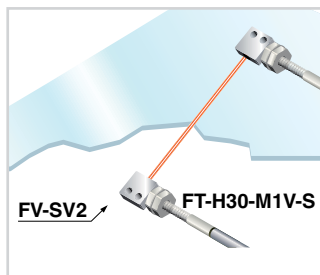

Detection over long ranges

FT-LE1 + FX10□



Detection of glass substrate in vacuum chamber

FD-H30-KZ1V + FX10□

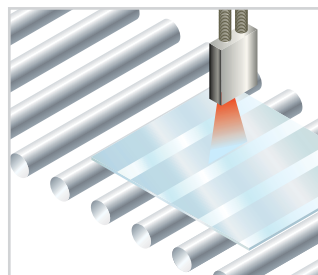

Detection of glass substrate on robot hand

FD-H30-L32V + FX10□

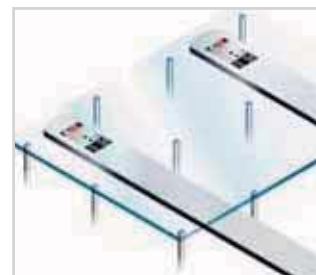

Technical Specifications

Model no.	Type	Standard type		Long sensing range type	
		Connector type	Cable set	Connector type	Cable set
		NPN output	FX-101 (-Z) (Note 2)	FX-101-CC2	FX-102 (-Z) (Note 2)
	PNP output	FX-101P (-Z) (Note 2)	FX-101P-CC2	FX-102P (-Z) (Note 2)	FX-102P-CC2
Supply voltage	12 to 24VDC±10%, Ripple P-P 10% or less				
Power consumption	Normal operation: 720mW or less (Current consumption 30mA or less at 24V supply voltage) ECO mode: 600mW or less (Current consumption 25mA or less at 24V supply voltage)				
Output	<NPN output type> NPN open-collector transistor		<PNP output type> PNP open-collector transistor		
Output operation	Selectable either Light-ON or Dark-ON, at SET mode				
Short-circuit protection	Incorporated				
Response time	Response time 0:	250µs or less	Response time 1:	2.5ms or less	
	Response time 1:	450µs or less	Response time 2:	2.8ms or less	
	Response time 2:	500µs or less	Response time 3:	3.2ms or less	
	Response time 3:	600µs or less	Response time 4:	5.0ms or less	
Sensitivity setting	2-level teaching/Limit teaching/Full-auto teaching				
Digital display	4 digit green + 4 digit red LCD display				
Timer function	ON-delay/OFF-delay timer, switchable either effective or ineffective. [Timer period:1ms, 5ms, 10ms, 20ms, 40ms, 50ms, 100ms, 500ms, 1000ms]				
Interference prevention function	Incorporated Selectable response time method (Note 1) (Functions at response time 1, 2 or 3)		Incorporated Selectable response time method (Note 1) (Functions at response time 1, 2, 3 or 4)		
Ambient temperature	-10 to +55°C (if 4 to 7 units are mounted close together: -10 to +50°C; if 8 to 16 units are mounted close together: -10 to +45°C (no dew condensation or icing allowed); Storage: -20 to +70°C				
Emitting element (modulated)	Red LED (Peak emission wavelength : 632nm)				
Material	Enclosure: polycarbonate; key switch: polycarbonate; fiber lock lever: PBT				
Connecting method	Connector (Note 2)				
Cable extension	Extension up to total 100m is possible with 0.3mm ² , or more, cable.				
Weight	Net weight: 15g approx. Gross weight: 35g approx.	Net weight: 15g approx. Gross weight: 75g approx.	Net weight: 15g approx. Gross weight: 35g approx.	Net weight: 15g approx. Gross weight: 75g approx.	Net weight: 15g approx. Gross weight: 75g approx.
Accessory	—	CN-14A-C2 (connector attached cable, 2m long): 1pc	—	CN-14A-C2 (connector attached cable, 2m long): 1pc	—

Notes: 1) When using the interference prevention function, set the response time for the amplifiers to be covered by the interference prevention function to different response time values. However, the interference prevention function does not operate at response time 0 (factory default setting) for the FX-101(P)(-Z)/FX-101(P)-CC2.
2) Connector attached cable CN-14A-C2 is not attached to the models that have no '-CC2' at the end of the model names.
Make sure to use the optional cable with connector CN-14A-CM.
Model n°s. having the suffix '-Z' are M8 plug-in connector type. Make sure to use the optional M8 plug-in connector cable, UZZ808xx.



FX-301

Enhanced functions and performance but still easy to use

Features

■ FX-301(P) (red LED type) version upgrade

We improved the standard model by enhancing its sensing stability and equipping it with handy functions such as the light-emitting amount selection function.

■ Super short response time of 35μs

The FX-301(P)-HS model is the digital type fiber sensor realizing a super short response time of 35μs rendering it capable of sensing minute objects moving at high speeds.

■ Stable sensing over long and short periods

In addition to a light emitting element for fiber optic sensors a new APC (Auto Power Control) circuit has also been adopted. Both support a stable level of light emission over long periods. Because fluctuations over short periods of time have also been suppressed, stable sensing is possible very quickly once the power is turned back on after setup changes.

■ Sensing range has been greatly increased

All models use a *double coupling lens* that enables a much wider sensing range and maximization in the light emission efficiency. Sensing ranges with small diameter fibers and ultra small diameter fibers, which have become very popular due to the miniaturization of chip components, have been increased by 50% over previous values achieved with other amplifiers.

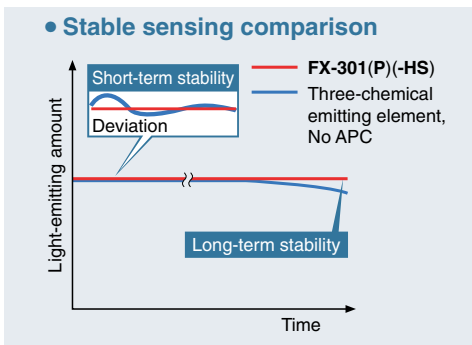
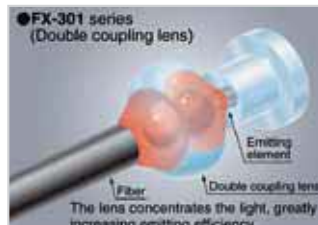

Typical Applications

Red LED type – FX-301(P)(-HS)

Workpiece detection

This standard type of FX-301(P)(-HS) using red light has a four-chemical emitting element for stable sensing over long periods.

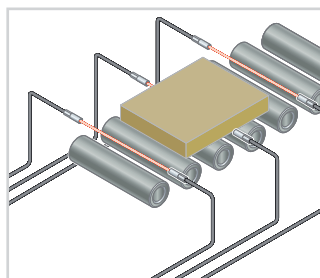

Blue LED type – FX-301B(P)

Sensing translucent stickers

The blue LED type greatly reduces the damping rate, making it ideal for delicate sensing.



Green LED type – FX-301G(P)

Sensing register marks

The green LED type greatly reduces the damping rate, making it ideal for delicate sensing.



Infrared LED type – FX-301H(P)

Sensing film meandering

Infrared LED type is ideal for sensing environments with light restrictions, such as places where light-sensitive film is being handled.

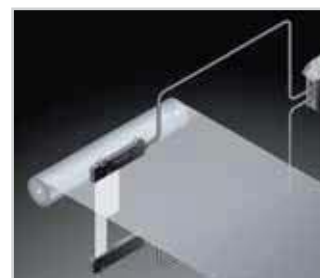

Object sensing during the painting process

Due to a sensing range of 19.5m (FX-301 long range mode) and a 10m fiber length, it can be lead through explosive atmospheres freely.



Engine block passage confirmation

FD-WKZ1 has realized a sensing range of 480mm (FX-301 long range mode). In addition, due to its powerful beam, it can even work in adverse environments such as in areas prone to dust.

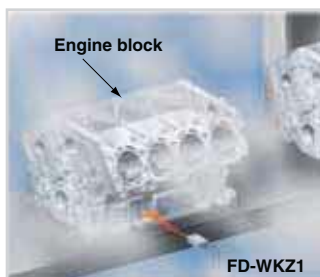

Wire breakage detection

The blue LED type greatly reduces the damping rate, making it ideal for delicate sensing.

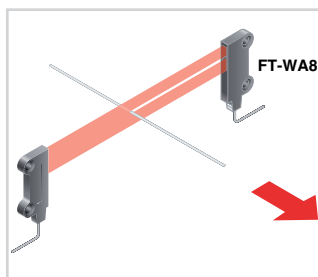

Technical Specifications

Type		Standard type ¹⁾	High speed
Model. no.	NPN output	FX-301□	FX-301-HS
	PNP output	FX-301□P	FX-301P-HS
Sensing range (Red LED type)		Thru-beam type (FT-B8): 1100mm (LONG), 530mm (STD), 400mm (FAST), 200mm (H-SP), 180mm (S-D) Reflective type (FD-B8): 480mm (LONG), 220mm (STD), 160mm (FAST), 85mm (H-SP), 75mm (S-D)	Thru-beam type (FT-B8): 1100mm (LONG), 530mm (STD), 400mm(FAST), 160mm (H-SP), 180mm (S-D) Reflective type (FD-B8): 480mm (LONG), 220mm (STD), 160mm (FAST), 60mm (H-SP), 75mm (S-D)
Supply voltage		12 to 24VDC ±10%	
Output		NPN output type: NPN open-collector transistor PNP output type: PNP open-collector transistor	
Output operation		Selectable either Light-ON or Dark-ON, with jog switch	
Response time		65µs or less [H-SP (Red LED type only)]; 150µs or less (FAST); 250µs or less [STD/S-D] (Red LED type only); 2ms or less (LONG) selectable with jog switch	35µs or less (H-SP); 150µs or less (FAST); 250µs or less (STD/S-D); 2ms or less (LONG) selectable with jog switch

Type		Standard type ¹⁾	High speed
Model. no.	NPN output	FX-301□	FX-301-HS
	PNP output	FX-301□P	FX-301P-HS
Sensitivity setting		2-level teaching/Limit teaching/Manual adjustment/Full-auto teaching	
Digital display		4-digit red LED display	
Automatic interference prevention function		Incorporated [(Up to 4 sets of fiber heads can be mounted close together.) (However, H-SP mode is 2 sets.)]	
Ambient temperature		-10 to +55°C (If 4 to 7 units are connected in cascade: -10 to +50°C, if 8 to 16 units are connected in cascade: -10 to +45°C)	
Emitting element (modulated)		FX-301(P): Red LED, FX-301B(P): Blue LED, FX-301G(P): Green LED, FX-301H(P): Infrared LED	Red LED
Dimensions (W×H×D)		10×30.5×64.5mm	

Note: 1) The cable for amplifier connection is not supplied as an accessory. Make sure to use the optional quick-connection cable given below.

- Main cable (3-core): CN-73-C1 (cable length 1m), CN-73-C2 (cable length 2m), CN-73-C5 (cable length 5m)
- Sub cable (1-core): CN-71-C1 (cable length 1m), CN-71-C2 (cable length 2m), CN-71-C5 (cable length 5m)



FX-311

Remarkably easy to use, yet employs the latest in technology

Features

■ 12-turn potentiometer with visible indicator

12-turn potentiometer has been incorporated for fine adjustments. It enables very fine differences to be detected. Since the potentiometer is illuminated, you can even make adjustments easily in dark areas.

■ Three light source types (red, green, blue) are made available for expanding applications

Rapid blinking 'assist function' eases adjustment for optimum sensitivity.

Typical Applications

Detecting transparent PET bottles

The green LED type is ideal for stably sensing objects such as transparent bottles which yield only small amounts of light fluctuation.



Register mark detection

The blue LED type can accurately sense yellow marks on white backgrounds that are difficult to sense using the red LED type.



Technical Specifications

Model no.	NPN output	FX-311
	PNP output	FX-311P
Supply voltage	12 to 24VDC±10%, Ripple P-P 10% or less	
Power consumption	840mW or less (Current consumption 35mA or less at 24V supply voltage)	
Output	<NPN output type> NPN open-collector transistor (FX-311) <PNP output type> PNP open-collector transistor (FX-311P)	
Output operation	Selectable either Light-ON or Dark-ON, with selection switch	
Short-circuit protection	Incorporated	
Response time	250µs or less (STD / S-D), 2ms or less (LONG) selectable with selection switch	
Operation indicator	Orange LED (lights up when the output is ON)	
Timer function	Incorporated with OFF-delay timer, selectable either effective (approx. 10ms or 40ms) or ineffective	
Automatic interference prevention function	Incorporated (Up to 4 sets of fiber heads can be mounted closely.) (Note 1)	
Ambient temperature	-10 to +55°C (if 4 to 7 units are mounted close together: -10 to +50°C; if 8 to 16 units are mounted close together: -10 to +45°C (no dew condensation or icing allowed); Storage: -20 to +70°C	
Emitting element (modulated)	Red LED	
Material	Enclosure: Heat-resistant ABS, Case cover: Polycarbonate	
Connecting method	Connector (Note 2)	
Cable extension	Extension up to total 100m is possible with 0.3mm ² , or more, cable	
Weight	15g approx.	

Notes: 1) When the power supply is switched on, the emission timing are automatically set for interference prevention.
2) The cable for amplifier connection is not supplied as an accessory. Make sure to use the optional quick-connection cable given below.
Main cable (3-core): CN-73-C1 (cable length 1m), CN-73-C2 (cable length 2m), CN-73-C5 (cable length 5m).
Sub cable (1-core): CN-71-C1 (cable length 1m), CN-71-C2 (cable length 2m), CN-71-C5 (cable length 5m).

40th Anniversary MODEL



FX-500

FX-500

The highest performance available

Features

A different stability

When used with the super quality fiber as a set, the incident light intensity variation among units is decreased to only 1/4 of that of conventional models.



High performance

FX-500 with its ultra short response time improves productivity.



HYPER mode incorporated

FX-500 in combination with the small diameter fiber can handle challenging detections over a super long sensing range.



A new accuracy!

FX-500 with its accurate detection catches fractional difference in light intensity, fulfilling high precision and low-hysteresis applications.

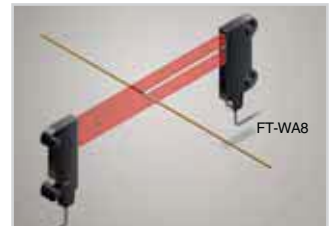

No PLC necessary saving material and programming costs

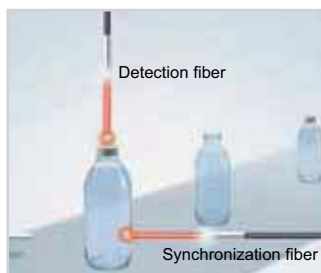

Logical calculation functions

Three logical calculations (AND, OR, XOR), are selectable using Output 1 of multiple FX-500 series amplifiers. A PLC is not required which helps to reduce material and programming and costs.

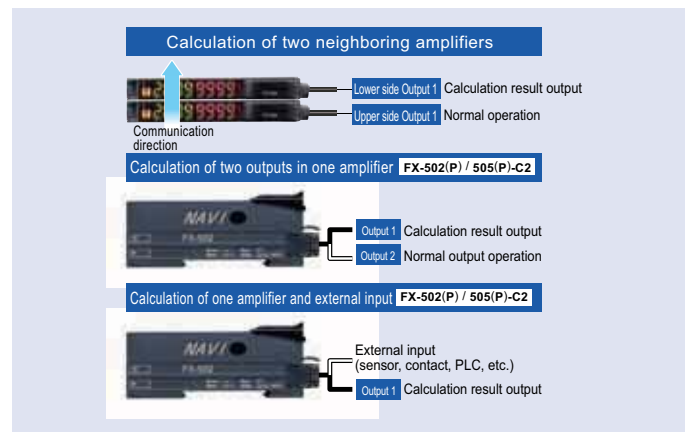

Analog output cable type FX505

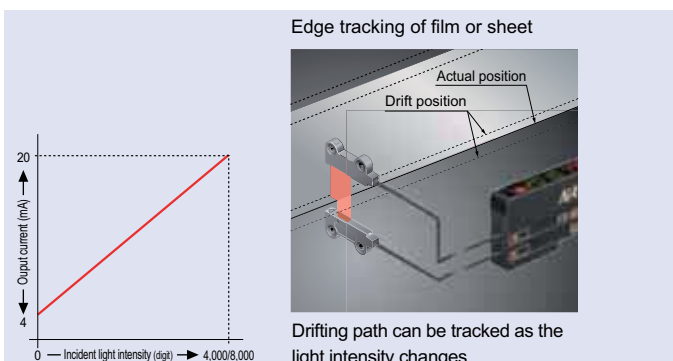

FX-500 Technical Specifications

	Standard type	Two outputs type	Analog output type
NPN output PNP output	FX-501 FX-501P	FX-502 FX-502P	FX-505-C2 FX-505P-C2
Type of amplifier	Digital		
Timer function	Adjustable: 0.1ms to 999.9ms in 0.1ms steps, 1 to 9999ms in 1ms steps, 1 to 32s in 1s steps		
Interference prevention function	Auto interference prevention function for up to 12 units or selectable response time method		
Sensing range	Depends on fiber type used		
Response time	25μs/60μs/250μs/2ms/4ms/24ms or less		
Analogue output			4 to 20mA
Output transistor	Max. 100mA		
Emitting element	Red LED (Peak emission wavelength: 650nm)		
Material	Enclosure: ABS; switch TPEE		
Rated current consumption	Normal operation: 40mA or less at 24V supply voltage Eco mode: 30mA or less at 24V supply voltage		
Protection	IP40		
Physical size (HxWxL)	34x10x75mm		
Connection method	Connector attached cable (note)		cable, 2m
Operating voltage	12-24V DC (±10%)		
Usable ambient temp.	-10°C to +55°C		
Weight approx.	70g		100g

Note: The cable for amplifier connection is not supplied as an accessor. Make sure to use the optional quick-connection cable given below.

For FX-501(P)

Main cable (3-core): CN-73-C1 (1m), CN-73-C2 (2m), CN-73-C5 (5m)
Sub cable (1-core): CN-71-C1 (1m), CN-71-C2 (2m), CN-71-C5 (5m)

For FX-502(P)

Main cable (4-core): CN-74-C1 (1m), CN-74-C2 (2m), CN-74-C5 (5m)
Sub cable (2-core): CN-72-C1 (1m), CN-72-C2 (2m), CN-72-C5 (5m)

Typical Applications

Counting of IC pins

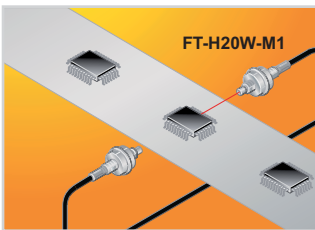

Check crimping

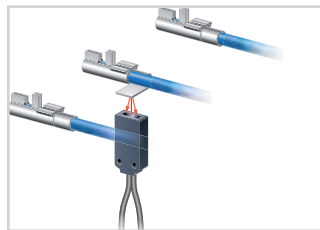

Detection of glass substrate



■ A quality that surpassed standard fiber

Stable emission intensity ±10%

Variation in emission intensity of the fiber core is controlled down to less than ±10%, achieving a stable detection.



Integrated high-precision plug

The centering precision of the fiber core attached to the inserting plug is doubled. As the insertion precision is increased, the variation among units can be greatly suppressed.



More flexible!

Bending radius = R4mm
[Previous was R25mm]



More bendable!



Bending durability = 10 million times
[Previous was 1,000 times]



■ Super Quality Fibers

LIST OF SUPER QUALITY FIBERS

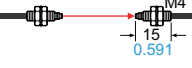
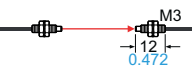
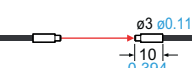
Thru-beam type (one pair set)

Type	Shape of fiber head (mm in)	Sensing range (mm in)			Beam axis dia. (mm in)	Fiber cable length	Bending radius	Ambient temperature	Model No.		
		■ : HYPR ■ : STD ■ : H-SP	U-LG	LONG						FAST	
Threaded	M4		3,600 (Note) 141.732	1,200 47.244	190 7.480	U-LG: 2,200 86.614 LONG: 1,700 66.929 FAST: 530 20.866	ø1 ø0.039	2 m 6.562 ft	R4 mm R0.157 in Allowable bending radius	-55 to +80 °C -67 to +176 °F	FT-40
	M3		1,350 53.150	400 15.748	75 2.953	U-LG: 810 31.890 LONG: 650 25.591 FAST: 210 8.268	ø0.5 ø0.020				
Cylindrical	ø3 ø0.118		3,600 (Note) 141.732	1,200 47.244	190 7.480	U-LG: 2,200 86.614 LONG: 1,700 66.929 FAST: 530 20.866	ø1 ø0.039				FT-S30
	ø1.5 ø0.059		1,350 53.150	400 15.748	75 2.953	U-LG: 810 31.890 LONG: 650 25.591 FAST: 210 8.268	ø0.5 ø0.020				FT-S20

Reflective type

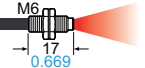
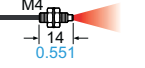
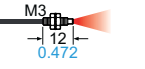
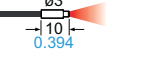
Type	Shape of fiber head (mm in)	Sensing range (mm in)			Fiber cable length	Bending radius	Ambient temperature	Model No.		
		■ : HYPR ■ : STD ■ : H-SP	U-LG	LONG					FAST	
Threaded	M6		1,550 61.024	520 20.472	90 3.543	U-LG: 900 35.433 LONG: 740 29.134 FAST: 260 10.236	2 m 6.562 ft	R4 mm R0.157 in Allowable bending radius	-55 to +80 °C -67 to +176 °F	FD-60
	M4		600 23.622	160 6.299	25 0.984	U-LG: 330 12.992 LONG: 250 9.843 FAST: 80 3.150				FD-40
	M3		600 23.622	160 6.299	25 0.984	U-LG: 330 12.992 LONG: 250 9.843 FAST: 80 3.150				FD-30
Cylindrical	ø3 ø0.118		600 23.622	160 6.299	25 0.984	U-LG: 330 12.992 LONG: 250 9.843 FAST: 80 3.150				FD-S30

SUPER QUALITY FIBER SPECIFICATIONS

Item	Type	Thru-beam type	Reflective type
	Model No.	FT-40, FT-30, FT-S30, FT-S20	FD-60, FD-40, FD-30, FD-S30
Variation of fiber head		Within ±10 %	
Beam axis precision		Beam axis position: Within ±150 μm, Inclination of beam axis: Within ±2 °	Beam axis position: Within ±150 μm, Inclination of beam axis: Within ±3 °
Allowable bending radius		R4 mm R0.157 in or more	
Bending durability		10 million times or more	
Ambient temperature		-55 to +80 °C -67 to +176 °F (No dew condensation or icing allowed), Storage: -55 to +80 °C -67 to +176 °F	
Ambient humidity		35 to 85 % RH, Storage: 35 to 85 % RH	
Material	Fiber core	Acrylic	
	Sheath	Polyethylene	
	Fiber head	Stainless steel (SUS303)	
	Plug	ABS	
Accessories		All fibers: FX-AT2 (fiber attachment) 1 pc. Threaded head fibers: Nuts 2 pcs. (Thru-beam type: 4 pcs.) and toothed lock washer 1 pc. (Thru-beam type: 2 pcs.)	

Fiber Optic Sensors

FX-500

LIST OF FIBERS

Pliable fibers (flexible and sharp bending fibers) are marked in light blue in the table.

Thru-beam type (one pair set)



Type	Shape of fiber head (mm in)	Sensing range (mm in)		Beam axis dia. (mm in)	Fiber cable length ✂️: Free-cut	Bending radius	Ambient temperature	Model No.
		■ : HYPR ■ : STD ■ : H-SP	U-LG LONG FAST					
Threaded type	Lens mountable (FX-LE1/LE2/SV1) 	3,600 141.732	U-LG : 2,400 94.488	ø1.5 ø0.059	2 m 6.562 ft	R25 mm R0.984 in	-40 to +70 °C -40 to +158 °F	FT-B8
	Metal-free	1,250 49.213	LONG : 2,100 82.677					
	Lens mountable (FX-LE1/LE2/SV1)	180 7.087	FAST : 570 22.441					
	Sleeve 90 mm 3.543 in	3,300 129.921	U-LG : 2,000 78.740					
	Sleeve 40 mm 1.575 in	1,100 43.307	LONG : 1,550 61.024					
	Lens mountable (FX-LE1/LE2/SV1)	150 5.906	FAST : 445 17.520					
	Lens mountable (FX-LE1/LE2/SV1)	3,300 129.921	U-LG : 1,800 70.866					
	Lens mountable (FX-LE1/LE2/SV1)	790 31.102	LONG : 1,400 55.118					
	Lens mountable (FX-LE1/LE2/SV1)	140 5.512	FAST : 420 16.535					
	Lens mountable (FX-LE1/LE2/SV1)	3,300 129.921	U-LG : 2,000 78.740					
Lens mountable (FX-LE1/LE2/SV1)	810 31.890	LONG : 1,500 59.055						
Lens mountable (FX-LE1/LE2/SV1)	160 6.299	FAST : 470 18.504						
Lens mountable (FX-LE1/LE2/SV1)	1,600 62.992	U-LG : 1,600 62.992						
Lens mountable (FX-LE1/LE2/SV1)	880 34.646	LONG : 1,600 62.992						
Lens mountable (FX-LE1/LE2/SV1)	160 6.299	FAST : 530 20.866						
Lens mountable (FX-LE1/LE2/SV1)	1,200 47.244	U-LG : 640 25.197						
Lens mountable (FX-LE1/LE2/SV1)	350 13.780	LONG : 560 22.047						
Lens mountable (FX-LE1/LE2/SV1)	60 2.362	FAST : 210 8.268						
Square head type	Lens mountable (FX-LE1/LE2/SV1) W7 × H9 × D13.9 W0.276 × H0.354 × D0.547	2,600 102.362	U-LG : 1,300 51.181	ø1 ø0.039	2 m 6.562 ft	R1 mm R0.039 in	-40 to +60 °C -40 to +140 °F	FT-WR80
	With lens	660 25.984	LONG : 1,100 43.307					
Elbow	Lens mountable (FX-LE1/LE2) 	3,500 137.795	U-LG : 1,750 68.898	ø1 ø0.039	2 m 6.562 ft	R25 mm R0.984 in	-40 to +70 °C -40 to +158 °F	FT-R80
	Lens mountable (FX-LE1/SV1)	780 30.709	LONG : 1,100 43.307					
M3	Lens mountable (FX-LE1/SV1) 	3,600 141.732	U-LG : 3,600 141.732	ø1 ø0.039	2 m 6.562 ft	R25 mm R0.984 in	-40 to +70 °C -40 to +158 °F	FT-T80
	Lens mountable (FX-LE1/SV1)	2,200 86.614	LONG : 3,300 129.921					
	Lens mountable (FX-LE1/SV1)	470 18.504	FAST : 1,300 51.181					
M3	Lens mountable (FX-LE1/SV1) 	3,300 129.921	U-LG : 2,000 78.740	ø1 ø0.039	2 m 6.562 ft	R25 mm R0.984 in	-40 to +70 °C -40 to +158 °F	FT-T80
	Lens mountable (FX-LE1/SV1)	1,100 43.307	LONG : 1,550 61.024					
M3	Lens mountable (FX-LE1/SV1)	150 5.906	FAST : 445 17.520	ø0.5 ø0.020	2 m 6.562 ft	R25 mm R0.984 in	-40 to +70 °C -40 to +158 °F	FT-NFM2
	Lens mountable (FX-LE1/SV1)	1,220 48.031	U-LG : 740 29.134					
M3	Lens mountable (FX-LE1/SV1)	310 12.205	LONG : 545 21.457	ø0.5 ø0.020	2 m 6.562 ft	R25 mm R0.984 in	-40 to +70 °C -40 to +158 °F	FT-NFM2
	Lens mountable (FX-LE1/SV1)	63 2.480	FAST : 192 7.559					

LIST OF FIBERS

Pliable fibers (flexible and sharp bending fibers) are marked in light blue in the table.

Thru-beam type (one pair set)



Type	Shape of fiber head (mm in)	Sensing range (mm in)		Beam axis dia. (mm in)	Fiber cable length	Bending radius	Ambient temperature	Model No.		
		■ : HYPR ■ : STD ■ : H-SP	U-LG LONG FAST							
Threaded type	Sleeve 90 mm 3.543 in 	1,220 48.031 310 12.205	U-LG : 740 29.134 LONG : 545 21.457 FAST : 192 7.559	$\varnothing 0.5$ $\varnothing 0.020$	 2 m	Fiber R25 mm R0.984 in Sleeve R10 mm R0.394 in	-40 to +70 °C -40 to +158 °F	FT-NFM2S		
		63 2.480	U-LG : 590 23.228 LONG : 440 17.323 FAST : 150 5.906					$\varnothing 0.6$ $\varnothing 0.024$	 2 m	R1 mm R0.039 in
		960 37.795 250 9.843 53 2.087	U-LG : 360 14.173 LONG : 270 10.630 FAST : 95 3.740	$\varnothing 0.6$ $\varnothing 0.024$	 2 m	R1 mm R0.039 in R4 mm R0.157 in Flexible	-40 to +60 °C -40 to +140 °F	FT-W4		
		650 25.591 160 6.299 30 1.181	U-LG : 360 14.173 LONG : 270 10.630 FAST : 95 3.740	$\varnothing 0.6$ $\varnothing 0.024$	 2 m	R4 mm R0.157 in Flexible	-40 to +70 °C -40 to +158 °F	FT-P40		
Long sensing range		19,600 771.652 19,600 771.652 4,000 157.480	U-LG : 19,600 771.652 LONG : 19,600 771.652 FAST : 13,000 511.810	$\varnothing 10$ $\varnothing 0.394$	 10 m 32.808 ft	R25 mm R0.984 in	-40 to +70 °C -40 to +158 °F	FT-FM10L		
Cylindrical type	With lens • Long sensing range 	3,600 141.732 3,300 129.921 640 25.197	U-LG : 3,600 141.732 LONG : 3,500 137.795 FAST : 1,700 66.929	$\varnothing 2$ $\varnothing 0.079$	 2 m	R1 mm R0.039 in	-40 to +60 °C -40 to +140 °F	FT-WS8L		
		790 31.102 3,300 129.921	U-LG : 1,900 74.803 LONG : 1,400 55.118 FAST : 460 18.110	$\varnothing 1$ $\varnothing 0.039$				FT-WS3		
	With lens • Long sensing range 	3,600 141.732 2,600 102.362 440 17.323	U-LG : 3,600 141.732 LONG : 3,500 137.795 FAST : 1,400 55.118	$\varnothing 2$ $\varnothing 0.079$	 2 m	R25 mm R0.984 in	-40 to +70 °C -40 to +158 °F	FT-SFM2L		
		1,100 43.307 3,300 129.921	U-LG : 2,000 78.740 LONG : 1,550 61.024 FAST : 445 17.520	$\varnothing 1$ $\varnothing 0.039$				FT-SFM2		
		150 5.906 3,300 129.921	U-LG : 1,800 70.866 LONG : 1,400 55.118 FAST : 420 16.535	$\varnothing 1$ $\varnothing 0.039$				R1 mm R0.039 in	-40 to +60 °C -40 to +140 °F	FT-WS8
		1,220 48.031 310 12.205 63 2.480	U-LG : 740 29.134 LONG : 545 21.457 FAST : 192 7.559	$\varnothing 0.5$ $\varnothing 0.020$	 2 m	R25 mm R0.984 in	-40 to +70 °C -40 to +158 °F	FT-SNFM2		
		960 37.795 250 9.843 53 2.087	U-LG : 590 23.228 LONG : 440 17.323 FAST : 150 5.906	$\varnothing 0.5$ $\varnothing 0.020$				R1 mm R0.039 in	-40 to +60 °C -40 to +140 °F	FT-WS4
		1,200 47.244 330 12.992 70 2.756	U-LG : 770 30.315 LONG : 570 22.441 FAST : 200 7.874	$\varnothing 0.6$ $\varnothing 0.024$				R4 mm R0.157 in Flexible	-40 to +70 °C -40 to +158 °F	FT-P2
		350 13.780 90 3.543 19 0.748	U-LG : 210 8.268 LONG : 160 6.299 FAST : 60 2.362	$\varnothing 0.25$ $\varnothing 0.010$				R4 mm R0.157 in Flexible	-40 to +60 °C -40 to +140 °F	FT-PS1

Fiber Optic Sensors

FX-500

LIST OF FIBERS

Pliable fibers (flexible and sharp bending fibers) are marked in light blue in the table.

Thru-beam type (one pair set)



Type	Shape of fiber head (mm in)	Sensing range (mm in)		Beam axis dia. (mm in)	Fiber cable length : Free-cut	Bending radius	Ambient temperature	Model No.	
		■ : HYPR ■ : STD ■ : H-SP	U-LG LONG FAST						
Cylindrical type Side-view		3,600 141.732	3,600 141.732	U-LG: 3,600 LONG: 3,600 FAST: 2,400	ø2.5 ø0.098	2 m 6.562 ft	R25 mm R0.984 in	-40 to +60 °C -40 to +140 °F	FT-V10
		3,500 137.795	850 33.465	2,200 86.614					
		3,500 137.795	570 22.441	100 3.937	1,200 47.244	ø0.8 ø0.031	1 m 3.281 ft	-20 to +60 °C -4 to +140 °F	FT-V22
		3,500 137.795	300 11.811	90 3.543	790 31.102				
		3,500 137.795	100 3.937	20 0.787	380 14.961	ø0.5 ø0.020	R1 mm R0.039 in	-40 to +60 °C -40 to +140 °F	FT-WV42
				220 8.661	2.2 x 3 0.087 x 0.118				
Rectangular Compact	Easy mounting • Top sensing W3 x H8 x D12 W0.118 x H0.315 x D0.472	3,600 141.732	3,300 129.921	630 24.803		U-LG: 3,600 LONG: 3,500 FAST: 1,800	R1 mm R0.039 in	-40 to +60 °C -40 to +140 °F	FT-Z8H
		3,600 141.732	2,100 82.677	410 16.142	U-LG: 3,600 LONG: 3,300 FAST: 1,300	R4 mm R0.157 in Flexible			
	Easy mounting • Side sensing W3 x H12 x D8 W0.118 x H0.472 x D0.315	3,600 141.732	3,400 133.858	590 23.228	U-LG: 3,600 LONG: 3,600 FAST: 1,850	R1 mm R0.039 in	-40 to +60 °C -40 to +140 °F	FT-Z8E	
		3,600 141.732	2,000 78.740	490 19.291	U-LG: 3,600 LONG: 3,300 FAST: 1,300	R4 mm R0.157 in Flexible			FT-WZ8
	Easy mounting • Front sensing W8.5 x H12 x D3 W0.335 x H0.472 x D0.118	3,600 141.732	1,300 51.181	280 11.024	U-LG: 3,100 LONG: 2,300 FAST: 830	R1 mm R0.039 in	-40 to +60 °C -40 to +140 °F	FT-Z8	
		3,600 141.732	1,200 47.244	250 9.843	U-LG: 2,700 LONG: 2,100 FAST: 750	R4 mm R0.157 in Flexible			FT-WZ4
	Front sensing W10 x H7 x D2 W0.394 x H0.276 x D0.079	1,600 62.992	530 20.866	100 3.937	U-LG: 1,100 LONG: 900 FAST: 330	ø1.5 ø0.059	1 m 3.281 ft	-40 to +60 °C -40 to +140 °F	
	Fiber bending type W2 x H10 x D10 W0.079 x H0.394 x D0.394	800 31.496	210 8.268	40 1.575	U-LG: 460 LONG: 370 FAST: 130				ø0.5 ø0.020
	Front sensing W14 x H7 x D3.5 W0.551 x H0.276 x D0.138	3,500 137.795	1,400 55.118	290 11.417	U-LG: 3,300 LONG: 2,300 FAST: 890	ø1.5 ø0.059	2 m 6.562 ft	FT-WZ7HB	
	Fiber bending type W3.5 x H14 x D11 W0.138 x H0.551 x D0.433	3,500 137.795	790 31.102	160 6.299	U-LG: 1,700 LONG: 1,300 FAST: 490				ø1 ø0.039

LIST OF FIBERS

Pliable fibers (flexible and sharp bending fibers) are marked in light blue in the table.

Thru-beam type (one pair set)



Type	Shape of fiber head (mm in)	Sensing range (mm in)		Beam axis dia. (mm in)	Fiber cable length ✂: Free-cut	Bending radius	Ambient temperature	Model No.
		■: HYPR ■: STD ■: H-SP	U-LG LONG FAST					
Narrow beam		3,600 141.732	U-LG : 3,600 LONG : 3,600 FAST : 2,700 106.299	ø2.2 ø0.087		R25 mm R0.984 in		FT-K8
	Side-view type with small light dispersion 	3,600 141.732	U-LG : 3,600 LONG : 3,600 FAST : 2,400 94.488	ø2.5 ø0.098	2 m 6.562 ft	R1 mm R0.039 in	-40 to +60 °C -40 to +140 °F	FT-WKV8
		760 29.921	U-LG : 3,600 LONG : 3,600 FAST : 2,700 106.299			R25 mm R0.984 in		FT-KV8
		2,400 94.488	U-LG : 1,100 LONG : 850 FAST : 430 16.929	ø1 ø0.039		R10 mm R0.394 in		FT-KV1
Wide beam	Wide area sensing 	3,600 141.732	U-LG : 3,600 LONG : 3,600 FAST : 3,600 141.732	3.2 x 3.2 0.126 x 1.260		R1 mm R0.039 in	-40 to +55 °C -40 to +131 °F	FT-WA30
		3,300 129.921			2 m 6.562 ft	R10 mm R0.394 in	-40 to +60 °C -40 to +140 °F	FT-A30
Special	Wide area sensing 	3,600 141.732	U-LG : 3,600 LONG : 3,600 FAST : 3,300 129.921	2.2 x 11 0.087 x 0.433		R1 mm R0.039 in	-40 to +55 °C -40 to +131 °F	FT-WA8
		980 38.583				R10 mm R0.394 in	-40 to +70 °C -40 to +158 °F	FT-A8
Array	Top sensing 	3,500 137.795	U-LG : 2,000 LONG : 1,500 FAST : 490 19.291	0.265 x 5.5 0.010 x 0.217	2 m 6.562 ft	R25 mm R0.984 in	-40 to +70 °C -40 to +158 °F	FT-AFM2
	Side sensing 	160 6.299						FT-AFM2E
Heat-resistant	350 °C 662 °F Lens mountable (FX-LE1/LE2/SV1) 	1,200 47.244	U-LG : 880 LONG : 670 FAST : 250 9.843	ø1.2 ø0.047	2 m 6.562 ft	R25 mm R0.984 in	-60 to +350 °C -76 to +662 °F	FT-H35-M2
	350 °C 662 °F Sleeve 60 mm 2.362 in 	80 3.150				Fiber R25 mm R0.984 in Sleeve R10 mm R0.394 in		FT-H35-M2S6
	Allows flexible wiring 200 °C 392 °F Lens mountable (FX-LE1/LE2/SV1) 	1,600 62.992	U-LG : 1,000 LONG : 840 FAST : 300 11.811	ø0.8 ø0.031	1 m 3.281 ft	R10 mm R0.394 in	-60 to +200 °C	FT-H20W-M1
	200 °C 392 °F Lens mountable (FX-LE1/LE2/SV1) 	470 18.504					-76 to +392 °F	FT-H20-M1
	130 °C 266 °F Lens mountable (FX-LE2 only) 	1,600 62.992	U-LG : 1,300 LONG : 960 FAST : 330 12.992	ø1.2 ø0.047		R25 mm R0.984 in		FT-H20-M1
	540 21.260						FT-H20-M1	
	110 4.331						FT-H20-M1	
	3,300 129.921	U-LG : 1,900 LONG : 1,300 FAST : 410 16.142	ø1.5 ø0.059	2 m 6.562 ft			-60 to +130 °C -76 to +266 °F	FT-H13-FM2
	700 27.559						FT-H13-FM2	
	140 5.512						FT-H13-FM2	

LIST OF FIBERS

Pliable fibers (flexible and sharp bending fibers) are marked in light blue in the table.

Thru-beam type (one pair set)



Type	Shape of fiber head (mm in)	Sensing range (mm in)		Beam axis dia. (mm in)	Fiber cable length Free-cut	Bending radius	Ambient temperature	Model No.		
		■ : HYPR ■ : STD ■ : H-SP	U-LG LONG FAST							
Heat-resistant • Joint	Lens mountable (FX-LE1/LE2/SV1) 	 1,600 62.992 470 18.504 90 3.543	U-LG : 1,000 39.370 LONG : 790 31.102 FAST : 300 11.811	ø1.2 ø0.047	200 mm 7.874 in	Heat-resistant fiber R18 mm R0.709 in	-60 to +200 °C -76 to +392 °F	FT-H20-J20-S		
		300 mm 11.811 in	FT-H20-J30-S							
		500 mm 19.685 in	FT-H20-J50-S							
	Side-view 	 2,100 82.677 600 23.622 120 4.724	U-LG : 1,300 51.181 LONG : 980 38.583 FAST : 390 15.354		500 mm 19.685 in			FT-H20-VJ50-S		
		800 mm 31.496 in	FT-H20-VJ80-S							
		800 mm 31.496 in	FT-H20-VJ80-S							
Special	Easy mounting • Rectangular head SEMI S2 compliant W7 × H15 × D13 W0.276 × H0.591 × D0.512 	 3,600 141.732 3,100 122.047 470 18.504	U-LG : 3,600 141.732 LONG : 3,600 141.732 FAST : 1,900 74.803	ø3.7 ø0.146	2 m 6.562 ft	R25 mm R0.984 in	0 to +60 °C 32 to +140 °F	FT-Z802Y		
		2 m 6.562 ft	FT-Z802Y							
	Chemical-resistant 115 °C 239 °F 	 3,600 141.732 3,600 141.732 740 29.134	U-LG : 3,600 141.732 LONG : 3,600 141.732 FAST : 2,300 90.551		2 m 6.562 ft			R30 mm R1.181 in	-40 to +115 °C -40 to +239 °F	FT-HL80Y
		2 m 6.562 ft	FT-L80Y							
	Side-view 	 3,600 141.732 1,300 51.181 240 9.449	U-LG : 2,800 110.236 LONG : 2,200 86.614 FAST : 800 31.496		ø2.8 ø0.110			R30 mm R1.181 in	-40 to +70 °C -40 to +158 °F	FT-V80Y
2 m 6.562 ft		FT-V80Y								
Vacuum-resistant	300 °C 572 °F Lens mountable (FV-LE1/SV2 only) 	 1,000 39.370 270 10.630 55 2.165	U-LG : 590 23.228 LONG : 470 18.504 FAST : 160 6.299	ø1.2 ø0.047	1 m 3.281 ft	R18 mm R0.709 in	-30 to +300 °C -22 to +572 °F	FT-H30-M1V-S		

LIST OF FIBERS

Pliable fibers (flexible and sharp bending fibers) are marked in light blue in the table.

Retroreflective type



Type	Shape of fiber head (mm in)	Sensing range (mm in)		Fiber cable length ✂ : Free-cut 2 m 6.562 ft	Bending radius R1 mm R0.039 in	Ambient temperature -25 to +55 °C -13 to +131 °F	Model No.
		■ : HYPR ■ : STD ■ : H-SP	U-LG LONG FAST				
Sharp bending With polarizing filters			U-LG : 100 to 1,400 3.937 to 74.803 LONG : 100 to 1,200 3.937 to 38.976 FAST : 100 to 780 3.937 to 30.709		R1 mm R0.039 in	-25 to +55 °C -13 to +131 °F	FR-WKZ11
Narrow beam	Top sensing 		U-LG : 200 7.874 LONG : 200 7.874 FAST : 200 7.874		R10 mm R0.394 in	-40 to +60 °C -40 to +140 °F	FR-KZ21
	Side sensing 		U-LG : 200 7.874 LONG : 200 7.874 FAST : 200 7.874				FR-KZ21E
Water mapping			U-LG : 20 to 460 0.787 to 18.110 LONG : 20 to 410 0.787 to 16.142 FAST : 20 to 220 0.787 to 8.661		R10 mm R0.394 in	-40 to +60 °C -40 to +140 °F	FR-KV1

Fiber Optic Sensors

FX-500

LIST OF FIBERS

Pliable fibers (flexible and sharp bending fibers) are marked in light blue in the table.

Reflective type



Type	Shape of fiber head (mm in)	Sensing range (mm in)			U-LG LONG FAST	Fiber cable length ✂ : Free-cut	Bending radius	Ambient temperature	Model No.
		■ : HYPR	■ : STD	■ : H-SP					
Threaded type	M6 	1,450 57.087	490 19.291	100 3.937	U-LG : 960 LONG : 860 FAST : 330 12.992	✂ 2 m 6.562 ft	R25 mm R0.984 in	-40 to +70 °C -40 to +158 °F	FD-B8
	M6 Metal-free • Coaxial 	1,000 39.370	420 16.535	60 2.362	U-LG : 680 LONG : 600 FAST : 200 7.874				FD-G60
	M6 Coaxial 	1,400 55.118	420 16.535	60 2.362	U-LG : 800 LONG : 650 FAST : 200 7.874				FD-FM2
	M6 Sleeve 90 mm 3.543 in 	1,100 43.307	380 14.961	70 2.756	U-LG : 700 LONG : 540 FAST : 220 8.661				FD-FM2S
	M6 Sleeve 40 mm 1.575 in 	870 34.252	250 9.843	45 1.772	U-LG : 560 LONG : 420 FAST : 140 5.512				FD-W8
	M6 	820 32.283	280 11.024	55 2.165	U-LG : 610 LONG : 480 FAST : 160 6.299				FD-P80
	M6 Tough flexible 	450 17.717	270 10.630	50 1.969	U-LG : 370 LONG : 330 FAST : 160 6.299				FD-P81X
	M6 Elbow 	890 35.039	220 8.661	40 1.575	U-LG : 500 LONG : 370 FAST : 130 5.118				FD-R80
	M4 	1,100 43.307	380 14.961	70 2.756	U-LG : 700 LONG : 540 FAST : 220 8.661				FD-T80
	M4 Sleeve 90 mm 3.543 in 	510 20.079	120 4.724	22 0.866	U-LG : 280 LONG : 215 FAST : 70 2.756				FD-NFM2
M4 Sleeve 40 mm 1.575 in 	330 12.992	80 3.150	12 0.472	U-LG : 180 LONG : 140 FAST : 45 1.772	FD-NFM2S				
M4 Sleeve 40 mm 1.575 in 	870 34.252	250 9.843	45 1.772	U-LG : 560 LONG : 420 FAST : 140 5.512	FD-NFM2S4				
M4 Sleeve 40 mm 1.575 in 	330 12.992	80 3.150	12 0.472	U-LG : 180 LONG : 140 FAST : 45 1.772	FD-W44				
M4 	870 34.252	250 9.843	45 1.772	U-LG : 560 LONG : 420 FAST : 140 5.512	FD-WT8				

LIST OF FIBERS

Pliable fibers (flexible and sharp bending fibers) are marked in light blue in the table.

Reflective type



Type	Shape of fiber head (mm in)	Sensing range (mm in) (Note 1)		Fiber cable length	Bending radius	Ambient temperature	Model No.	
		■ : HYPR ■ : STD ■ : H-SP	U-LG LONG FAST					
Threaded type	M4 Minute objects can be detected due to the small spot beam. Coaxial • Lens mountable (FX-MR1/MR2/MR3/MR5/MR6)	590 23.228	U-LG : 340 LONG : 13.386 FAST : 11.024	Free-cut	R2 mm R0.079 in	-40 to +60 °C -40 to +140 °F	FD-WG4	
		150 5.906	LONG : 280 FAST : 90					
		25 0.984	FAST : 3.543					
	M4 Metal-free • Coaxial	550 21.654	U-LG : 330 LONG : 12.992 FAST : 10.630	2 m 6.562 ft	R25 mm R0.984 in	-40 to +70 °C -40 to +158 °F	FD-G4	
		140 5.512	LONG : 270 FAST : 80					
		27 1.063	FAST : 3.150					
	M4	490 19.291	U-LG : 250 LONG : 9.843 FAST : 7.480	Free-cut	R4 mm R0.157 in Flexible	-40 to +60 °C -40 to +140 °F	FD-P60	
		120 4.724	LONG : 190 FAST : 75					
		22 0.866	FAST : 2.953					
	M3	Small diameter	510 20.079	U-LG : 280 LONG : 11.024 FAST : 8.465	Free-cut	R25 mm R0.984 in	-40 to +70 °C -40 to +158 °F	FD-T40
			120 4.724	LONG : 215 FAST : 70				
			22 0.866	FAST : 2.756				
M3		330 12.992	U-LG : 180 LONG : 7.087 FAST : 5.512	2 m 6.562 ft	R1 mm R0.039 in	-40 to +60 °C -40 to +140 °F	FD-WT4	
		80 3.150	LONG : 140 FAST : 45					
		12 0.472	FAST : 1.772					
M3		190 7.480	U-LG : 100 LONG : 3.937 FAST : 3.346	Free-cut	R4 mm R0.157 in Flexible	-40 to +70 °C -40 to +158 °F	FD-P40	
		45 1.772	LONG : 85 FAST : 20					
		7 0.276	FAST : 0.787					
M3		Lens mountable (FX-MR3, FX-MR6) Coaxial	550 21.654	U-LG : 330 LONG : 12.992 FAST : 10.630	Free-cut	R25 mm R0.984 in	-40 to +60 °C -40 to +140 °F	FD-G6
			140 5.512	LONG : 270 FAST : 80				
			27 1.063	FAST : 3.150				
	Tough flexible Lens mountable (FX-MR3, FX-MR6) Coaxial	630 24.803	U-LG : 370 LONG : 14.567 FAST : 12.205	Free-cut	R10 mm R0.394 in	-40 to +60 °C -40 to +140 °F	FD-G6X	
		170 6.693	LONG : 310 FAST : 95					
		27 1.063	FAST : 3.740					
	High precision Lens mountable (FX-MR3, FX-MR6) Coaxial	170 6.693	U-LG : 100 LONG : 3.937 FAST : 3.150	Free-cut	R25 mm R0.984 in	-40 to +60 °C -40 to +140 °F	FD-EG1	
		40 1.575	LONG : 80 FAST : 24					
		7.5 0.295	FAST : 0.945					
	High precision Lens mountable (FX-MR3, FX-MR6) Coaxial	130 5.118	U-LG : 100 LONG : 3.937 FAST : 3.150	500 mm 19.685 in	R10 mm R0.394 in	-20 to +60 °C -4 to +140 °F	FD-EG2	
		24 0.945	LONG : 80 FAST : 19					
		3 0.118	FAST : 0.748					
High precision Lens mountable (FX-MR3, FX-MR6) Coaxial	85 3.346	U-LG : 45 LONG : 1.772 FAST : 1.378	Free-cut	R10 mm R0.394 in	-20 to +60 °C -4 to +140 °F	FD-EG3		
	20 0.787	LONG : 35 FAST : 12						
	3.5 0.138	FAST : 0.472						
Coaxial	190 7.480	U-LG : 110 LONG : 4.331 FAST : 3.543	1 m 3.281 ft	R25 mm R0.984 in	-40 to +60 °C -40 to +140 °F	FD-ENM1S1		
	50 1.969	LONG : 90 FAST : 28						
	9 0.354	FAST : 1.102						
Cylindrical type	ø3 ø0.118	1,100 43.307	U-LG : 700 LONG : 27.559 FAST : 21.260	Free-cut	R25 mm R0.984 in	-40 to +70 °C -40 to +158 °F	FD-S80	
		380 14.961	LONG : 540 FAST : 220					
ø3 ø0.118	960 37.795	U-LG : 550 LONG : 21.654 FAST : 16.142	2 m 6.562 ft	R1 mm R0.039 in	-40 to +60 °C -40 to +140 °F	FD-WS8		
	250 9.843	LONG : 410 FAST : 140						

Fiber Optic Sensors

FX-500

LIST OF FIBERS

Pliable fibers (flexible and sharp bending fibers) are marked in light blue in the table.

Reflective type



Type	Shape of fiber head (mm in)	Sensing range (mm in)		Fiber cable length : Free-cut	Bending radius	Ambient temperature	Model No.	
		: HYPR : STD : H-SP	U-LG LONG FAST					
Cylindrical type	Coaxial 	590 23.228	U-LG : 340 LONG : 280 FAST : 90	2 m 6.562 ft	R2 mm R0.079 in	-40 to +60 °C -40 to +140 °F	FD-WSG4	
		150 5.906	U-LG : 250 LONG : 190 FAST : 75					
	Coaxial 	490 19.291	U-LG : 250 LONG : 190 FAST : 75	2 m 6.562 ft	R4 mm R0.157 in Flexible	-40 to +70 °C -40 to +158 °F	FD-P50	
		120 4.724	U-LG : 280 LONG : 215 FAST : 70					
	Coaxial 	510 20.079	U-LG : 280 LONG : 215 FAST : 70	2 m 6.562 ft	R25 mm R0.984 in	-40 to +70 °C -40 to +158 °F	FD-SNFM2	
		120 4.724	U-LG : 170 LONG : 140 FAST : 55					
	Coaxial 	260 10.236	U-LG : 170 LONG : 140 FAST : 55	1 m 3.281 ft	R4 mm R0.157 in Flexible	-40 to +60 °C -40 to +140 °F	FD-P2	
		80 3.150	U-LG : 25 LONG : 22 FAST : 7					
	Ultra-small diameter	Sleeve part cannot be bent.	45 1.772	U-LG : 25 LONG : 22 FAST : 7	1 m 3.281 ft	R10 mm R0.394 in	-40 to +60 °C -40 to +140 °F	FD-E12
			12 0.472	U-LG : 130 LONG : 110 FAST : 32				
Ultra-small diameter	Sleeve part cannot be bent.	210 8.268	U-LG : 130 LONG : 110 FAST : 32	1 m 3.281 ft	R25 mm R0.984 in	-40 to +70 °C -40 to +158 °F	FD-E22	
		55 2.165	U-LG : 140 LONG : 110 FAST : 35					
Side-view	Small diameter Sleeve part cannot be bent.	260 10.236	U-LG : 140 LONG : 110 FAST : 35	1 m 3.281 ft	R25 mm R0.984 in	-40 to +60 °C -40 to +140 °F	FD-V41	
		65 2.559	U-LG : 35 LONG : 25 FAST : 8					
		14 0.551	U-LG : 35 LONG : 25 FAST : 8					
Side-view	Sleeve part cannot be bent.	60 2.362	U-LG : 35 LONG : 25 FAST : 8	2 m 6.562 ft	R1 mm R0.039 in		FD-WV42	
		16 0.630	U-LG : 250 LONG : 210 FAST : 75					
Side-view	Sleeve part cannot be bent.	370 14.567	U-LG : 250 LONG : 210 FAST : 75	1 m 3.281 ft	R25 mm R0.984 in	-20 to +60 °C -4 to +140 °F	FD-SFM2SV2	
		120 4.724	U-LG : 25 LONG : 24 FAST : 24					
Rectangular	Glass substrate detection • Mapping W25 × H7.3 × D30 W0.584 × H0.287 × D1.161	1 to 110 0.039 to 4.331	U-LG : 1 to 87 LONG : 1 to 74 FAST : 1 to 38	4 m 13.123 ft	R25 mm R0.984 in	-40 to +60 °C -40 to +140 °F	FD-L46	
		1 to 56 0.039 to 2.205	U-LG : 43 LONG : 43 FAST : 40					
	Glass substrate detection • Alignment W20 × H29 × D3.8 W0.787 × H1.142 × D0.150	43 1.693	U-LG : 43 LONG : 43 FAST : 40	3 m 9.843 ft	R4 mm R0.157 in		FD-L45	
		40 1.575	U-LG : 4 to 47 LONG : 4 to 46 FAST : 4 to 42					
	Glass substrate detection • Alignment W23.5 × H29 × D4.5 W0.925 × H1.142 × D0.177	3 to 51 0.118 to 2.008	U-LG : 4 to 47 LONG : 4 to 46 FAST : 4 to 42	1 m 3.281 ft	R25 mm R0.984 in	0 to +70 °C 32 to +158 °F	FD-L45A	
		4 to 44 0.157 to 1.732	U-LG : 25 LONG : 24 FAST : 24					
Glass substrate detection • Alignment W17 × H29 × D3.8 W0.669 × H1.142 × D0.150	31 1.220	U-LG : 25 LONG : 24 FAST : 24	2 m 6.562 ft	R4 mm R0.157 in		FD-L43		
	24 0.945	U-LG : 30 LONG : 30 FAST : 28						
Glass substrate detection • Seating confirmation W18 × H29 × D3.8 W0.709 × H1.142 × D0.150	30 1.181	U-LG : 30 LONG : 30 FAST : 28	3 m 9.843 ft	R4 mm R0.157 in	-20 to +70 °C -4 to +158 °F	FD-L47		

LIST OF FIBERS

Pliable fibers (flexible and sharp bending fibers) are marked in light blue in the table.

Reflective type



Type	Shape of fiber head (mm in)	Sensing range (mm in)		Fiber cable length ☒ : Free-cut	Bending radius	Ambient temperature	Model No.
		■ : HYPR ■ : STD ■ : H-SP	U-LG LONG FAST				
Rectangular	Glass substrate detection • Seating confirmation W12 × H19 × D3 W0.472 × H0.748 × D0.118	■ 11.5 0.453 ■ 9.5 0.374 ■ 8 0.315	U-LG : 10.5 0.413 LONG : 10 0.394 FAST : 9 0.354	☒	R10 mm R0.394 in	-40 to +60 °C -40 to +140 °F	FD-L44
		■ 6 0.236 ■ 5 0.197 ■ 4 0.157	U-LG : 5.5 0.217 LONG : 5.5 0.217 FAST : 4.5 0.177				FD-L44S
	Glass substrate detection W24 × H21 × D4 W0.945 × H0.827 × D0.157	■ 1.5 to 15 0.059 to 0.591 ■ 2.5 to 14 0.098 to 0.551 ■ 6.5 to 10 0.256 to 0.394	U-LG : 2 to 14.5 0.079 to 0.571 LONG : 2 to 14.5 0.079 to 0.571 FAST : 5.5 to 13.5 0.217 to 0.531	☒ 2 m 6.562 ft	R1 mm R0.039 in		FD-WL41
		■ 1 to 19 0.039 to 0.748 ■ 1.5 to 16 0.059 to 0.630 ■ 8 to 11 0.315 to 0.433	U-LG : 1 to 18 0.039 to 0.709 LONG : 1.5 to 16 0.059 to 0.630 FAST : 3 to 15 0.118 to 0.591	☒	R10 mm R0.394 in		FD-L41
	 W6 × H18 × D14 W0.236 × H0.709 × D0.551	■ 21.5 0.846 ■ 15.5 0.610 ■ 5 to 7.5 0.197 to 0.295	U-LG : 19.5 0.768 LONG : 18.5 0.728 FAST : 3 to 13 0.118 to 0.512	☒		-40 to +70 °C -40 to +158 °F	FD-L4
 W7.2 × H7.5 × D2 W0.283 × H0.295 × D0.079	■ 16 0.630 ■ 7.5 0.295 ■ 0.5 to 4 0.020 to 0.157	U-LG : 12.5 0.492 LONG : 11.5 0.453 FAST : 0.5 to 6 0.020 to 0.236	☒ 1 m 3.281 ft	R1 mm R0.039 in	-20 to +60 °C -4 to +140 °F	FD-WL48	
Small	Front sensing W10 × H7 × D2 W0.394 × H0.276 × D0.079	■ 1 to 230 0.039 to 9.055 ■ 2 to 65 0.079 to 2.559 ■ 5 to 13 0.197 to 0.512	U-LG : 1 to 110 0.039 to 4.331 LONG : 1 to 85 0.039 to 3.346 FAST : 3 to 35 0.118 to 1.378	☒ 1 m 3.281 ft			FD-WZ4
		Fiber bending type W2 × H10 × D10 W0.079 × H0.394 × D0.394	■ 1 to 190 0.039 to 7.480 ■ 2.5 to 65 0.098 to 2.559 ■ 3 to 11 0.118 to 0.433	U-LG : 1 to 130 0.039 to 5.118 LONG : 1 to 90 0.039 to 3.543 FAST : 2.5 to 40 0.098 to 1.575	☒	R1 mm R0.039 in	-40 to +60 °C -40 to +140 °F
	Front sensing W14 × H7 × D3.5 W0.551 × H0.276 × D0.138	■ 430 16.929 ■ 110 4.331 ■ 3 to 25 0.118 to 0.984	U-LG : 230 9.055 LONG : 180 7.087 FAST : 1.5 to 65 0.059 to 2.559	☒ 2 m 6.562 ft			FD-WZ7
		Fiber bending type W3.5 × H14 × D11 W0.138 × H0.551 × D0.433	■ 0.5 to 560 0.020 to 22.047 ■ 1 to 150 0.039 to 5.906 ■ 2.5 to 30 0.098 to 1.181	U-LG : 0.5 to 320 0.020 to 12.598 LONG : 0.5 to 270 0.020 to 10.630 FAST : 1 to 90 0.039 to 3.543	☒		
Special	Long sensing range • Rectangular head W5.2 × H9.5 × D15 W0.205 × H0.374 × D0.591	■ 20 to 1,700 0.787 to 66.929 ■ 20 to 490 0.787 to 19.291 ■ 20 to 100 0.787 to 3.937	U-LG : 20 to 1,000 0.787 to 39.370 LONG : 20 to 820 0.787 to 32.283 FAST : 20 to 310 0.787 to 12.205	☒ 2 m 6.562 ft	R1 mm R0.039 in	-40 to +60 °C -40 to +140 °F	FD-WKZ1
		■ 200 7.874 ■ 200 7.874 ■ 75 2.953	U-LG : 200 7.874 LONG : 200 7.874 FAST : 140 5.512	☒ 2 m 6.562 ft	R25 mm R0.984 in		FD-A15
	Top sensing W5 × H20 × D20 W0.197 × H0.787 × D0.787	■ 660 25.984 ■ 280 11.024 ■ 50 1.969	U-LG : 510 20.079 LONG : 430 16.929 FAST : 160 6.299	☒ 2 m 6.562 ft	R25 mm R0.984 in	-40 to +70 °C -40 to +158 °F	FD-AFM2
		Side sensing W5 × H20 × D20 W0.197 × H0.787 × D0.787					

Fiber Optic Sensors

FX-500

LIST OF FIBERS

Pliable fibers (flexible and sharp bending fibers) are marked in light blue in the table.

Reflective type



Type	Shape of fiber head (mm in)	Sensing range (mm in)		Fiber cable length ✂ : Free-cut	Bending radius	Ambient temperature	Model No.	
		■ : HYPR ■ : STD ■ : H-SP	U-LG LONG FAST					
Liquid level sensing	Heat resistant 125 °C 257 °F Fluorine resin coating 	ø6 mm 0.236 in	720 28.346	U-LG : 540 LONG : 21.260 FAST : 460	2 m 6.562 ft	Protective tube R40 mm R1.575 in Fiber R15 mm R0.591 in	-40 to +125 °C -40 to +257 °F	FD-F8Y
	Heat resistant 105 °C 221 °F Fluorine resin coating 	ø4 mm 0.157 in	260 10.236	U-LG : 540 LONG : 21.260 FAST : 460	2 m 6.562 ft	Protective tube R20 mm R0.787 in Fiber R10 mm R0.394 in	-40 to +105 °C -40 to +221 °F	FD-HF40Y
	Heat resistant 70 °C 158 °F Fluorine resin coating throughout the fiber 	ø4 mm 0.157 in	260 10.236	U-LG : 540 LONG : 21.260 FAST : 460	2 m 6.562 ft	Protective tube R20 mm R0.787 in Fiber R10 mm R0.394 in	-40 to +70 °C -40 to +158 °F	FD-F41Y
	Mountable on pipe • Standard 	W25 × H13 × D20 W0.984 × H0.512 × D0.787	ø6 to ø26 mm 0.236 to 1.024 in transparent pipe	U-LG : 540 LONG : 21.260 FAST : 460	2 m 6.562 ft	Protective tube R20 mm R0.787 in Fiber R10 mm R0.394 in	-40 to +100 °C -40 to +212 °F	FD-F41
	Mountable on pipe • For PFA, wall thickness 1 mm 0.039 in pipe 	W25 × H13 × D20 W0.984 × H0.512 × D0.787	ø6 to ø26 mm 0.236 to 1.024 in transparent pipe	U-LG : 540 LONG : 21.260 FAST : 460	2 m 6.562 ft	Protective tube R20 mm R0.787 in Fiber R10 mm R0.394 in	-40 to +100 °C -40 to +212 °F	FD-F4
Liquid sensing	Mountable on pipe • Array fiber 	W6.5 × H28.3 × D17 W0.256 × H1.114 × D0.669	ø8 to ø80 mm 0.315 to 3.150 in	U-LG : 540 LONG : 21.260 FAST : 460	2 m 6.562 ft	Protective tube R20 mm R0.787 in Fiber R4 mm R0.157 in	-40 to +70 °C -40 to +158 °F	FD-FA90
	Mountable on pipe SEMI S2 compliant 	W23 × H20 × D17 W0.906 × H0.787 × D0.669	ø3 to ø10 mm 0.118 to 0.394 in transparent pipe	U-LG : 540 LONG : 21.260 FAST : 460	2 m 6.562 ft	Protective tube R20 mm R0.787 in Fiber R4 mm R0.157 in	-20 to +60 °C -4 to +140 °F	FT-F902
Liquid leak detection	SEMI S2 compliant 	W20 × H30 × D10 W0.787 × H1.181 × D0.394	ø3 to ø10 mm 0.118 to 0.394 in transparent pipe	U-LG : 540 LONG : 21.260 FAST : 460	5 m 16.404 ft Protective tube: 3 m 9.843 ft	Protective tube R20 mm R0.787 in Fiber R4 mm R0.157 in	-20 to +50 °C -4 to +122 °F	FD-F705
Heat-resistant	350 °C 662 °F • Coaxial 	ø2.8 0.110	720 28.346	U-LG : 540 LONG : 21.260 FAST : 460	2 m 6.562 ft	R25 mm R0.984 in	-60 to +350 °C -76 to +662 °F	FD-H35-M2
	350 °C 662 °F • Sleeve 60 mm 2.362 in 	ø2.8 0.110	45 1.772	U-LG : 540 LONG : 21.260 FAST : 460	2 m 6.562 ft	Fiber R25 mm R0.984 in Sleeve R10 mm R0.394 in	-60 to +350 °C -76 to +662 °F	FD-H35-M2S6
	200 °C 392 °F • Coaxial 	ø2.8 0.110	840 33.071	U-LG : 550 LONG : 500 FAST : 200	1 m 3.281 ft	R25 mm R0.984 in	-60 to +200 °C -76 to +392 °F	FD-H20-M1
	350 °C 662 °F • Sleeve 90 mm 3.543 in 	ø2.1 0.083	840 33.071	U-LG : 550 LONG : 500 FAST : 200	1 m 3.281 ft	Fiber R25 mm R0.984 in Sleeve R10 mm R0.394 in	-60 to +350 °C -76 to +662 °F	FD-H35-20S
	200 °C 392 °F • Coaxial 	ø2.1 0.083	770 30.315	U-LG : 500 LONG : 380 FAST : 130	2 m 6.562 ft	R25 mm R0.984 in	-60 to +200 °C -76 to +392 °F	FD-H20-21
	300 °C 572 °F • Glass substrate detection Convergent reflective type 	W19 × H27 × D5 W0.748 × H1.063 × D0.197	ø1.5 to 6 0.059 to 0.236	U-LG : 30 LONG : 25 FAST : 12	2 m 6.562 ft	R25 mm R0.984 in	-60 to +300 °C -76 to +572 °F	FD-H30-L32

LIST OF FIBERS

Pliable fibers (flexible and sharp bending fibers) are marked in light blue in the table.

Reflective type



Type	Shape of fiber head (mm in)	Sensing range (mm in)		Fiber cable length ✂️: Free-cut	Bending radius	Ambient temperature	Model No.
		■ : HYPR ■ : STD ■ : H-SP	U-LG LONG FAST				
Special	Heat-resistant 250 °C 482 °F • Glass substrate detection Convergent reflective type W21×H33.2×D5 W0.827×H1.307×D0.197	■ : 1 to 31 ■ : 0.039 to 1.220 ■ : 1.5 to 26 ■ : 0.059 to 1.024 ■ : 2 to 18 ■ : 0.079 to 0.709	U-LG : 1 to 30 ■ : 0.039 to 1.181 LONG : 1 to 28 ■ : 0.039 to 1.102 FAST : 1.5 to 24 ■ : 0.059 to 0.945	3 m 9.843 ft	R25 mm R0.984 in	-20 to +250 °C -4 to +482 °F (Ordinary temperature side: -20 to +70 °C -4 to +158 °F)	FD-H25-L43
		■ : 4 to 43.5 ■ : 0.157 to 1.713 ■ : 5 to 42 ■ : 0.197 to 1.654 ■ : 6.5 to 34 ■ : 0.256 to 1.339	U-LG : 4 to 43 ■ : 0.157 to 1.693 LONG : 4.5 to 43 ■ : 0.177 to 1.693 FAST : 5 to 40 ■ : 0.197 to 1.575				FD-H25-L45
	180 °C 356 °F • Glass substrate detection Convergent reflective type W19 × H27 × D5 W0.748 × H1.063 × D0.197	■ : 60 ■ : 2.362 ■ : 16 ■ : 0.630 ■ : 2 to 6.5 ■ : 0.079 to 0.256	U-LG : 32 ■ : 1.260 LONG : 24 ■ : 0.945 FAST : 13 ■ : 0.512	2 m 6.562 ft		-60 to +180 °C -76 to +356 °F	FD-H18-L31
	130 °C 266 °F M6 21 0.827	■ : 880 ■ : 34.646 ■ : 350 ■ : 13.780 ■ : 65 ■ : 2.559	U-LG : 640 ■ : 25.197 LONG : 600 ■ : 23.622 FAST : 200 ■ : 7.874			-60 to +130 °C -76 to +266 °F	FD-H13-FM2
	Vacuum-resistant 300 °C 572 °F • Rectangular head W9.5 × H5.2 × D15 W0.374 × H0.205 × D0.591	■ : 1 to 500 ■ : 0.039 to 19.685 ■ : 2 to 200 ■ : 0.079 to 7.874 ■ : 10 to 25 ■ : 0.394 to 0.984	U-LG : 1 to 340 ■ : 0.039 to 13.386 LONG : 1 to 270 ■ : 0.039 to 10.630 FAST : 3 to 120 ■ : 0.118 to 4.724	1 m 3.281 ft	R18 mm R0.709 in	-30 to +300 °C -22 to +572 °F	FD-H30-KZ1V-S
300 °C 572 °F • Glass substrate detection Convergent reflective type W19 × H5 × D27 W0.748 × H0.197 × D1.063	■ : 18 ■ : 0.709 ■ : 8 ■ : 0.315 ■ : 1.5 to 3 ■ : 0.059 to 0.118	U-LG : 12 ■ : 0.472 LONG : 10 ■ : 0.394 FAST : 5.5 ■ : 0.217	3 m 9.843 ft			FD-H30-L32V-S	

Accessories (attached with fibers)

- RF-003 (FR-KZ21/KZ21E exclusive reflector)
- RF-13 (Reflective tape)
- FX-CT1 (Fiber cutter)
- FX-CT2 (Fiber cutter)
- FX-CT3 (Fiber cutter)
- FX-AT2 (Attachment for fixed-length fiber, Orange)
- FX-AT3 (Attachment for ø2.2 mm ø0.087 in fiber, Clear orange)
- FX-AT4 (Attachment for ø1 mm ø0.039 in fiber, Black)
- FX-AT5 (Attachment for ø1.3 mm ø0.051 in fiber, Gray)
- FX-AT6 Attachment for ø1 mm ø0.039 in / ø1.3 mm ø0.051 in mixed fiber, Black / Gray

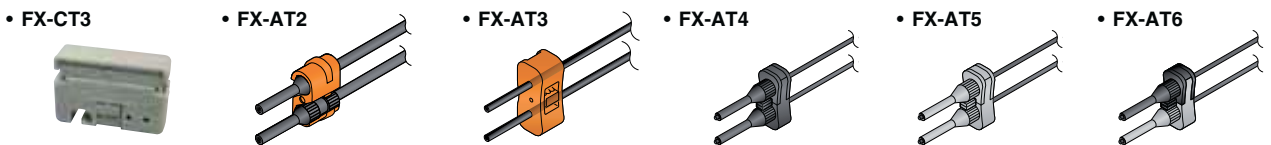



FX-CH2

External input unit for digital sensor

Features

■ Up to 16 sensors can be set/switched simultaneously by an external signal

Up to 16 digital fiber sensors can be set/switched simultaneously not by directly operating the sensors but from a PLC, a touch panel, a push button, or some other external signal generating device.

■ Simultaneous teaching

- Full-auto teaching
- 2-level teaching

■ Key lock setting

Even the enable/disable command for the key lock setting, a function designed to prevent operational mistakes, can be effectuated simultaneously from an external signal.

■ Batch loading and saving of bank settings

The bank settings for 3 previously set channels can be loaded and saved all together using an external signal.

Technical Specifications

Type	NPN input type	PNP input type
Model no.	FX-CH2	FX-CH2-P
Applicable sensor	FX-301(P) (Version upgrade), FX-305(P)	
Supply voltage	12 to 24VDC±10%	
Input	Low: 0 to +2VDC High: +5V to +VDC, or open	Low: 4V to +VDC High: 0 to +0.6VDC, or open
Power indicator	Green LED	
Transmission operation indicator	Green LED (lights up when loaded, and 2-level/limit teaching blinks lights up when saved, and full-auto teaching)	
Ambient temperature	-10 to +55°C (if 4 to 7 sensors are mounted close together: -10 to +50°C, If 8 to 16 sensors are mounted close together: -10 to +45°C)	
Dimensions	10×27×68.5mm	

Typical Applications

■ Setup changes (external automatic teaching/ data bank switching)

Digital fiber settings can be changed using input from a touch screen or switch, so that production line setup changes can be carried out more easily.

■ External teaching

Full auto-teaching is recommended for teaching when the sensing object is changed without stopping the line.

■ Data bank switching

Settings such as output operations (L-ON/D-ON) and timer operations can be recorded in the digital fiber sensor's data bank, and switching can be carried out externally.

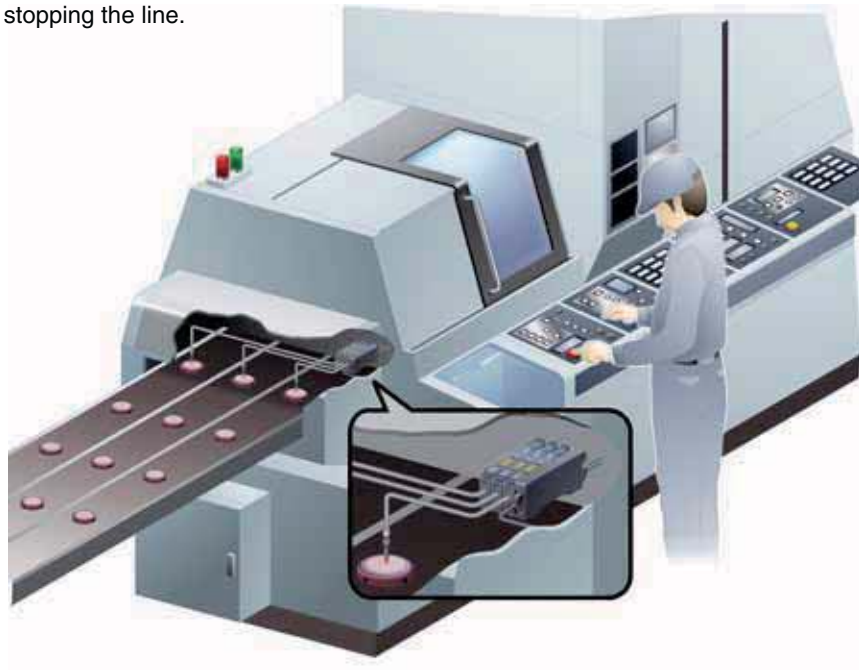

SC-GU1-485



SC-GU1-485

We now offer remote maintenance for digital sensors

Features

■ **Function handy for startup and maintenance**

Using a PLC or PC, this communication unit not only facilitates inputs (teaching, bank switching) to a digital fiber sensor [FX-301(P)/305(P)] but also received-light amount and output status verifications greatly enhance workability during startup and maintenance.

■ **Series connection (RS485) of a maximum of 31 nodes is possible**

A maximum of 31 nodes can be connected in series. This is ideal for flexible handling when the sensors are to be installed in scattered locations or when more sensors are added.

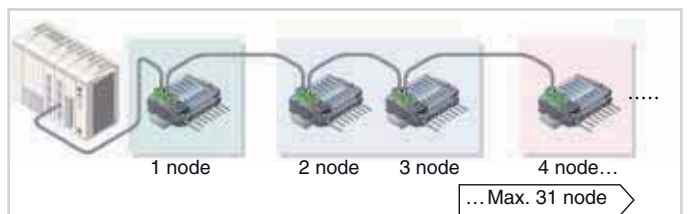
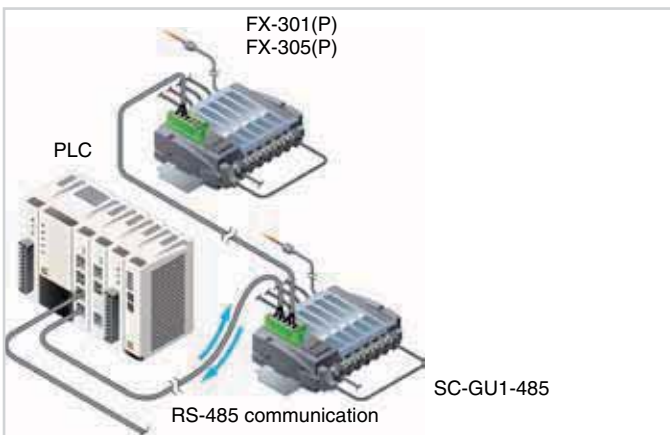

Technical Specifications

Type	Main Unit
Model no.	SC-GU1-485
Applicable sensor	FX-301 (P), FX-305 (P)
Supply voltage	24VDC±10% Ripple P-P10% or less
Ambient temperature	-10 to +55°C (if 4 to 7 sensors are connected: -10 to +50°C, If 8 to 16 sensors are mounted close together: -10 to +45°C) (No dew condensation or icing allowed), Storage: -20 to +70°C
Material	Enclosure: Heat-resistant ABS
Weight	35g approx. (10g approx. for SC-GU1-EU)

www.panasonic-electric-works.com



You need further information?

Please visit us: www.panasonic-electric-works.com

or call us: **Tel.: +49(0)8024 648-0**



Sharp bending fiber
Now, an even greater variety of sharp bending fibers

FT/FD-W

■ Compact bending same as electrical wires

With the smallest bending radius being over R1mm and the coaxial types capable of highly accurate sensing (FD-WG4 and FD-WSG4) being over R2mm, this fiber can bend sharply like a cable to reduce wasted space.

■ All 24 models! Complete lineup!

13 thru-beam models and 11 reflective models are available for a total of 24 models. You are sure to find the sharp bending fiber that is best for you.

■ Does not break even at sharp bends

It does not break even at sharp bends. Furthermore, due to low loss in light intensity, there is almost no affect on the sensing range.

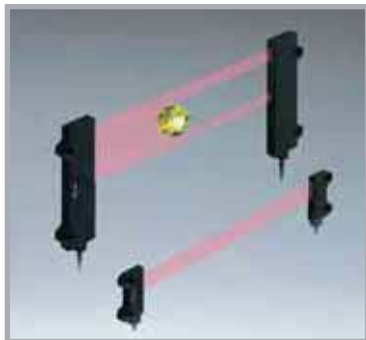
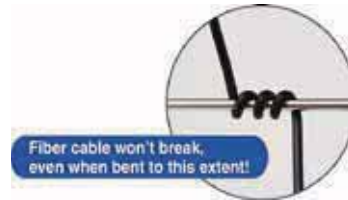

Wide beam fiber
Sensing possible across a wide area

FT-WA30/A30, FT-WA8/A8, FD-A15

■ Wide range

It has a wide sensing width of 11mm for FT-WA8/A8 and 32mm for FT-WA30/A30 enabling long distance sensing of objects as far as 3500mm (with FX-301 in LONG mode). Optimal for detecting unsteady objects or small objects.

■ Seal slit mask is available

A seal slit mask reduces the width and thereby the intensity of the emitting beam, which enables much smaller objects to be detected.

■ Space saving installation possible

FT-WA30/A30 and FT-WA8/A8 depth fibers boast a slim size of 20mm and 13.5mm respectively that enables mounting in even the narrowest of lines.

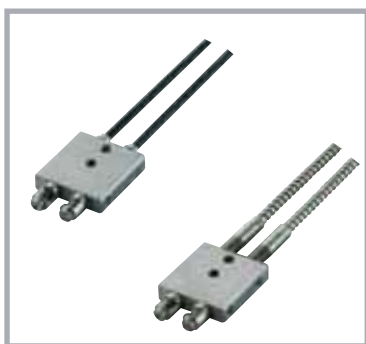

Heat-resistant, fixed-focus reflective fiber
Glass substrate detection in high temperature production line

FD-H30-L32 FD-H18-L31

- 2 types to choose from to match your working environment

- High precision detection

In addition to excellent heat resistance, these fibers have achieved a repeatability of 0.06mm for transparent glass substrates.

- Extended detection range

Now available with full-range detection capabilities containing no dead zones (in both LONG and STD modes). Also, an extended detection distance of 15mm (in LONG mode) has been achieved, which even allows warping in glass substrates to be detected.

- Glass substrate sensing

High temperature (300°C) production line glass substrate sensing possible. Accurately detects transparent glass substrates even at 300°C.

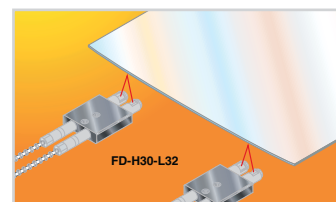

Heat-resistant reflective fiber with M4 head

FD-H20-21 FD-H35-20S

- Heat-resistant fiber saves installation space

The fiber head has M4 screw threads allowing installation space savings when using many fibers.

- High-precision positioning is possible

The 200°C heat-resistant fiber (FD-H20-21) uses a coaxial fiber that makes high-precision positioning possible.

- Heat-resistant fiber with sleeve (FD-H35-20S)

The sleeve is useful for cases when the fiber head cannot be installed close to the sensing location.

- Can be installed in narrow spaces

A flexible metal jacket sheath that allows cables to be routed easily has been adopted.



Sharp bending fiber
Now, an even greater variety of sharp bending fibers



Narrow beam retroreflective type fiber
Ideal for sensing transparent objects!

FR-KZ21/KZ21E

■ Stable sensing of transparent objects is possible!

A unique optical system gives excellent performance in sensing transparent objects at close ranges.

Uses an exclusive reflector (RF-003) for stable sensing of transparent objects such as transparent sheets on transparent mounts and transparent tubes.

■ Ultra compact fiber head & compact reflector!

The fiber head size is ultra compact at W9.52×H5.22×D21mm (side sensing type: W9.52×H25.2×D5.2mm). The reflector is also a compact W10.62×H28.2×D10.1mm so that it is very space efficient.

■ Two types of fiber head for different installation directions

Two types of fiber head are available: a *Top* sensing type (FR-KZ21) and a *Side* sensing type (FR-KZ21E). Whichever type best suits the installation conditions can be selected.



FR-WKZ11

■ Compact head and long sensing range

This fiber has a compact head of W9.5×H5.2×D15mm. It is a retroreflective type with a polarizing filter that has a long sensing range of 3200mm.

■ Unaffected by surface reflection from transparent objects

FR-WKZ11 has a built-in polarizing filter in its tip, so that it is unaffected by surface reflection from transparent objects and specular objects directly in front of it.

■ Gives stable detection of transparent objects

Because it is a retroreflective type, light passes through transparent objects twice, so differences in the amount of light can be easily picked up and glass substrate and transparent films can be detected with good stability.





Coaxial M3 head reflective fiber
High-precision & space saving

FD-G6

■ Fiber allows installation space saving

The fiber head has M3 screw threads, allowing installation space saving when using many fibers.

■ High-precision positioning is possible

This coaxial fiber has the emitting fiber at the center and the receiving fiber around it. This fiber is ideal for high-precision positioning.

■ Allows sensing of very small objects

FX-MR6 and **FX-MR3** finest spot lenses can be attached making this fiber ideal for sensing very small objects e.g. the orientation of chips.



Long sensing range rectangular head reflective fiber
Narrow field of view/long distance detection!

FD-WKZ1

■ Compact fiber head

FD-WKZ1 has a compact head with dimensions of 9.2×5.2×15mm (W×H×D).

■ Narrow-view reflective type fiber allows for accurate aiming through narrow aperture obstruction

The beam spread of FD-WKZ1 has been reduced to approximately 1/5 of that of conventional fiber, enabling detection through narrow apertures.

■ Long sensing range

Sensing can now be performed over distances of 480mm. Furthermore, the implementation of a powerful light beam allows the sensor to perform detection under difficult sensing conditions where high levels of dust and coarse particulates are present.

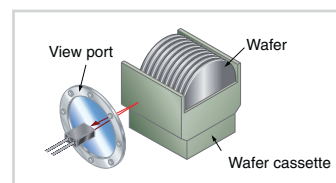

Optical Fibers for FX 100 Series

Thru-beam type (one pair set)



Fibers are listed in alphabetic order.

Model no.	Sensing range (mm)	
	Standard type FX-101□	Long sensing range type FX-102□
FT-A8	1500	3500
FT-A30	3500	3500
FT-AFM2	280	720
FT-AFM2E	240	670
FT-B8	400	1,150
FT-E12	6	19
FT-E22	15	60
FT-FM2		
FT-FM2S	300	800
FT-FM2S4		
FT-FM10L	9300	15,000
FT-H13-FM2	250	700
FT-H20-J20-S		
FT-H20-J30-S	135	420
FT-H20-J50-S		
FT-H20-M1	210	540
FT-H20-VJ50-S		
FT-H20-VJ80-S	150	500
FT-H20W-M1	100	300
FT-H30-M1V-S	110	280
FT-H35-M2		
FT-H35-M2S6	170	490
FT-HL80Y	990	2340
FT-K8	1000	3000
FT-KV1	135	500
FT-KV8	1000	3000
FT-L80Y	1100	2600
FT-NFM2		
FT-NFM2S	130	280
FT-NFM2S4		
FT-P2	120	330
FT-P40	80	240
FT-P60	130	300
FT-P80	230	650
FT-P81X	260	800

Model no.	Sensing range (mm)	
	Standard type FX-101□	Long sensing range type FX-102□
FT-PS1	40	90
FT-R80	180	430
FT-SFM2	300	800
FT-SFM2L	760	2400
FT-SFM2SV2	180	470
FT-SNFM2	130	280
FT-T80	300	800
FT-V10	1000	2350
FT-V22	140	380
FT-V41	40	120
FT-V80Y	340	800
FT-W4	80	220
FT-W8	260	650
FT-WA8	1500	3500
FT-WA30	3500	3500
FT-WKV8	700	2200
FT-WR80	215	570
FT-WR80L	430	1150
FT-WS3	150	600
FT-WS4	80	220
FT-WS8	260	650
FT-WS8L	600	1500
FT-WV42	30	80
FT-WZ4	230	670
FT-WZ4HB	80	230
FT-WZ7	330	1000
FT-WZ7HB	190	580
FT-WZ8	330	950
FT-WZ8E	700	2100
FT-WZ8H	1200	2800
FT-Z8	360	1000
FT-Z8E	800	1850
FT-Z8H	1400	3100
FT-Z802Y	520	3100

Optical Fibers for FX 100 Series

Retroreflective type

Fibers are listed in alphabetic order.

Model no.	Sensing range (mm) (Notes 1, 2)	
	Standard type FX-101□	Long sensing range type FX-102□
FR-KV1	15 to 200	15 to 360
FR-KZ21	200	200
FR-KZ21E	200	200
FR-WKZ11	100 to 550	100 to 830

Reflector	Amplifier	FX-101□	FX-102□
FR-WKZ11 + RF-210		100 to 700	100 to 1100
FR-WKZ11 + RF-220		100 to 1300	100 to 2600
FR-WKZ11 + RF-230		100 to 2000	100 to 4000

Reflective type

Fibers are in alphabetic order.

Model no.	Sensing range (mm) (Notes 1, 2)	
	Standard type FX-101□	Long sensing range type FX-102□
FD-A15	125	250
FD-AFM2	105	285
FD-AFM2E	85	245
FD-B8	170	440
FD-E12	3.5	13
FD-E22	16	45
FD-EG1	18	50
FD-EG2	10	30
FD-EG3	7	22
FD-EN500S1	1	4
FD-ENM1S1	15	48
FD-F4	Applicable pipe diameter: Outer dia. ø6 to ø26mm transparent pipe [PFA (fluorine resin) or equivalently transparent pipe, wall thickness 1mm]	
FD-F41	Applicable pipe diameter: Outer dia. ø6 to ø26mm transparent pipe [PVC (vinyl chloride), fluorine resin, polycarbonate, acrylic, glass, wall thickness 1 to 3mm]	
FD-F8Y	-	
FD-FM2	100	410
FD-FM2S	100	345
FD-FM2S4		
FD-G4	50	120

Model no.	Sensing range (mm) (Notes 1, 2)	
	Standard type FX-101□	Long sensing range type FX-102□
FD-G6	50	120
FD-G6X	45	160
FD-H13-FM2	100	280
FD-H18-L31	0 to 10	0 to 25
FD-H20-21	90	280
FD-H20-M1	120	300
FD-H30-KZ1V-S (Note 3)	25 to 80	10 to 220
FD-H30-L32	2 to 9	0 to 17
FD-H30-L32V-S (Note 3)	2.5 to 6.5	0 to 11
FD-H35-20S	85	200
FD-H35-M2	75	280
FD-H35-M2S6		
FD-L4	5 to 8 (Convergent point 6)	1 to 17 (Convergent point 6)
FD-L41	3 to 14 (Convergent point 8)	1.5 to 16 (Convergent point 8)
FD-L43	0 to 19	0 to 25
FD-L44	0 to 6	0 to 8
FD-L44S	0 to 4.5	0 to 5.5
FD-L45	0 to 40	0 to 50
FD-L46	16 to 30	12 to 50
FD-NFM2	35	100
FD-NFM2S		
FD-NFM2S4		
FD-P2	25	65

Optical Fibers for FX 100 Series

Reflective type



Fibers are listed in alphabetic order.

Model no.	Sensing range (mm)	
	Standard type FX-101□	Long sensing range type FX-102□
FD-P40	8	30
FD-P50	45	150
FD-P60	45	150
FD-P80	90	200
FD-P81X	70	220
FD-R80	70	180
FD-S80	100	345
FD-SFM2SV2	30	90
FD-SNFM2	35	100
FD-T40	35	100
FD-T80	100	345
FD-V41	25	70
FD-W8	80	230
FD-W44	15	40

Model no.	Sensing range (mm)	
	Standard type FX-101□	Long sensing range type FX-102□
FD-WG4	28	75
FD-WKZ1	20 to 180	20 to 480
FD-WL41	7 to 12 (Convergent point 8)	6 to 13.5 (Convergent point 8)
FD-WL48	1 to 4.5	0.5 to 6.5
FD-WS8	80	230
FD-WSG4	28	75
FD-WT4	15	40
FD-WT8	80	230
FD-WV42	6	20
FD-WZ4	2 to 20	1 to 70
FD-WZ4HB		
FD-WZ7	1 to 55	160
FD-WZ7HB	1 to 60	0.5 to 180

Optical Fibers for FX 300 Series

Thru-beam type (one pair set)



The FX-305 and FX-301(-HS) have different sensing modes.
FX-305: H-SP, FAST, STD, STDF, LONG, U-LG (no S-D mode)
FX-301(-HS): S-D, H-SP (Note 1), FAST, STD, LONG (no STDF or U-LG mode)

Type	Shape of fiber head (mm)	Sensing range (mm) (Note 1)	<ul style="list-style-type: none"> ■ U-LG ■ LONG ■ STDF ■ STD 	<ul style="list-style-type: none"> ■ FAST ■ H-SP ■ S-D 	Min. sensing object	Fiber cable length ✂ : Free-cut	Bending radius	Model no.				
M4	Lens mountable 	1600 1100 700 530	400 200 180	ø0.04mm opaque object	R25mm	✂ : Free-cut	R25mm	FT-B8				
	Lens mountable 							FT-FM2				
	Sleeve 90mm 	1000 780 500 400	280 150 130	ø0.03mm opaque object				Fiber R25mm Sleeve	FT-FM2S			
	Sleeve 40mm 							R10 mm R0.394 in	FT-FM2S4			
	Lens mountable 	750 570 350 290	200 90 100	ø0.03mm opaque object				R1 mm R0.039 in	FT-W8			
	Lens mountable 	900 650 400 320	230 100 110	ø0.04mm opaque object				R4 mm R0.157 in Flexible	FT-P80			
	Lens mountable 	900 650 380 320	230 100 110	ø0.05mm opaque object				1m	R10 mm R0.394 in	FT-P81X		
	Lens mountable 	550 400 250 190	140 70 80	ø0.04mm opaque object				✂ : Free-cut	2m	R4 mm R0.157 in Flexible	FT-P60	
	Thru-beam type	Square head type 	750 570 350 290	200 90 100				ø0.06mm opaque object	✂ : Free-cut	2m	R1 mm R0.039 in	FT-WR80
		With lens 	1500 1200 750 600	420 200 210				ø0.04mm opaque object	✂ : Free-cut	2m	R1 mm R0.039 in	FT-WR80L
Elbow	Lens mountable 	740 530 320 230	150 75 80	ø0.04mm opaque object	✂ : Free-cut	2m	R25mm	FT-R80				
M3	Lens mountable (except FX-LE2) 	1000 780 500 400	280 150 130	ø0.03mm opaque object	R25mm	✂ : Free-cut	R25mm	FT-T80				
								FT-NFM2				
	Sleeve 90mm 	400 270 200 140	100 55 49	ø0.025mm opaque object				Fiber R25mm Sleeve	FT-NFM2S			
	Sleeve 40mm 							R10 mm R0.394 in	FT-NFM2S4			
		220 160 100 80	55 25 28	ø0.02mm opaque object				R1 mm R0.039 in	FT-W4			
		350 250 150 100	75 30 35					R4 mm R0.157 in Flexible	FT-P40			
Long sensing range	With lens 	19,500 19,500 19,500 14,000	10,000 3500 3800	ø0.4mm opaque object	✂ : Free-cut	10m	R25mm	FT-FM10L				

Pliable fibers (flexible and sharp bending fibers) are marked with light red in the table.

Standard Fibers

Optical Fibers for FX 300 Series

Thru-beam type (one pair set)



The FX-305 and FX-301(-HS) have different sensing modes.
FX-305: H-SP, FAST, STD, STDF, LONG, U-LG (no S-D mode)
FX-301(-HS): S-D, H-SP (Note 1), FAST, STD, LONG (no STDF or U-LG mode)

Type	Shape of fiber head (mm)	Sensing range (mm)	<ul style="list-style-type: none"> ■ U-LG ■ LONG ■ STDF ■ STD 	<ul style="list-style-type: none"> ■ FAST ■ H-SP ■ S-D 	Min. sensing object (Note 2)	Fiber cable length ✂ : Free-cut	Bending radius	Model no.		
Cylindrical type	With lens • Long sensing range ø3	1500 1200 750 600	420 200 210	ø0.02mm opaque object	2m	✂	R1 mm R0.039 in	FT-WS8L		
		780 570 340 290	200 90 100	ø0.05mm opaque object				FT-WS3		
	With lens • Long sensing range ø2.5	2000 1600 820 800	580 170 280	ø0.02mm opaque object	2m	✂	R25mm	FT-SFM2L		
		1000 780 500 400	280 150 130	ø0.03mm opaque object				FT-SFM2		
		750 570 350 290	200 90 100	ø0.03mm opaque object				FT-WS8		
	ø1.5	400 270 200 140	100 55 49	ø0.025mm opaque object	2m	✂	R25mm	FT-SNFM2		
		220 160 100 80	55 25 28	ø0.02mm opaque object				FT-WS4		
		350 280 160 120	90 40 42	ø0.02mm opaque object				FT-P2		
	ø1	100 80 50 40	30 13 17	ø0.02mm opaque object	500mm		R4 mm R0.157 in Flexible	FT-PS1		
	Ultra small diameter	Beam diameter ø0.25 ø3 ø0.125 mm	20 18 13 10	8 3 3	ø0.02mm opaque object	500mm		R5mm	FT-E12	
		Beam diameter ø0.4 ø3 ø0.25 mm	130 80 60 50	36 18 15	ø0.02mm opaque object	1m			FT-E22	
	Side-view	ø4	2350 2000 1400 1000	800 340 350	ø0.05mm opaque object	2m	✂	R25mm	FT-V10	
ø1.5 ø2.5		550 400 240 200	140 65 70	ø0.02mm opaque object	FT-SFM2SV2					
ø1 ø2		410 390 220 180	125 60 63		1m				FT-V22	
ø1 ø2.5		220 175 100 80	60 25 27		2m				FT-V41	
ø1 ø2		120 90 55 40	30 13 15						R1 mm R0.039 in	FT-WV42
ø1 ø2										

Pliable fibers (flexible and sharp bending fibers) are marked with light red in the table.

Optical Fibers for FX 300 Series

Thru-beam type (one pair set)

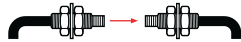

The **FX-305** and **FX-301(-HS)** have different sensing modes.
FX-305: H-SP, FAST, STD, STDF, LONG, U-LG (no S-D mode)
FX-301(-HS): S-D, H-SP (Note 1), FAST, STD, LONG (no STDF or U-LG mode)

Type	Shape of fiber head (mm)	Sensing range (mm) (Note 1)	<ul style="list-style-type: none"> ■ U-LG ■ LONG ■ STDF ■ STD 	<ul style="list-style-type: none"> ■ FAST ■ H-SP ■ S-D 	Min. sensing object (Note 2)	Fiber cable length ✂ : Free-cut	Bending radius	Model no.	
Rectangular	Easy mounting • Top sensing W3 × H8 × D12	3500 2500 1600 1200	400 410	850	∅0.08mm opaque object	✂ 2m	R1 mm R0.039 in	FT-WZ8H	
		3100 2700 1550 1400	420 490	1000	∅0.03mm opaque object		R4 mm R0.157 in Flexible	FT-Z8H	
	Easy mounting • Side sensing W3 × H12 × D8	2100 1500 950	200 210	500	∅0.05mm opaque object		R1 mm R0.039 in	FT-WZ8E	
		1850 1600 950 800	250 280	600	∅0.03mm opaque object		R4 mm R0.157 in Flexible	FT-Z8E	
	Easy mounting • Front sensing W8.5 × H12 × D3	950 700 420 330	240 100 120		∅0.04mm opaque object		R1 mm R0.039 in	FT-WZ8	
		1100 800 500 400	300 120 140		∅0.03mm opaque object		R4 mm R0.157 in Flexible	FT-Z8	
	Front sensing W10 × H7 × D2	300 200 140 100	70 40 40		∅0.08mm opaque object		✂ 1m	NEW FT-WZ4	
	Fiber bending type W2 × H10 × D10	220 150 105 75	50 30 30		∅0.08mm opaque object		✂ 2m	R1 mm R0.039 in	NEW FT-WZ4HB
	Front sensing W14 × H7 × D3.5	660 440 308 220	150 80 80		∅0.08mm opaque object			NEW FT-WZ7	
	Fiber bending type W3.5 × H14 × D11	870 580 406 290	210 110 110		∅0.03mm opaque object			NEW FT-WZ7HB	
Special	Narrow beam	∅3.5 ∅3.7	3000 2000 1500 1000	800 300 350			R25mm R0.984 in	FT-K8	
		Side-view type with small light dispersion	2200 1700 1000 700	600 280 300		∅0.06mm opaque object	✂ 2m	R1 mm R0.039 in	FT-WKV8
		W2 × H1.5 × D20	600 500 300 250	180 90 100		∅0.02mm opaque object	R10 mm R0.394 in	FT-KV1	
	Wide beam	Wide area sensing	(Note 3) 3500 (Note 3) 3500 (Note 3) 3500 (Note 3) 3500	(Note 4) 3500 (Note 4) 3000 (Note 4) 3500		∅0.3mm opaque object	✂ 2m	R1 mm R0.039 in	FT-WA30
Wide area sensing Sensing width 11mm		(Note 3) 3500 (Note 3) 3500 (Note 3) 3500 1500	1100 1080 750		∅0.25mm opaque object	R1 mm R0.039 in	FT-WA8		
W4.2 × H31 × D13.5						R10 mm R0.394 in	FT-A8		
Array	Top sensing W5 × H15 × D15	850 650 380 330	220 100 115		Horizontal: ∅0.025mm opaque object	✂ 2m	R25mm	FT-AFM2	
	Side sensing W5 × H15 × D15	800 590 350 290	200 90 100		Vertical: ∅0.45mm opaque object			FT-AFM2E	

Pliable fibers (flexible and sharp bending fibers) are marked with light red in the table.

Standard Fibers

Optical Fibers for FX 300 Series

Thru-beam type (one pair set)

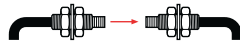

The FX-305 and FX-301(-HS) have different sensing modes.
FX-305: H-SP, FAST, STD, STDF, LONG, U-LG (no S-D mode)
FX-301(-HS): S-D, H-SP (Note 1), FAST, STD, LONG (no STDF or U-LG mode)

Type	Shape of fiber head (mm)	Sensing range (mm) (Note 2)	<ul style="list-style-type: none"> ■ U-LG ■ LONG ■ STDF ■ STD 	<ul style="list-style-type: none"> ■ FAST ■ H-SP ■ S-D 	Min. sensing object (Note 3)	Fiber cable length ✂ : Free-cut	Bending radius	Model no.		
Heat-resistant	350°C Lens mountable 	750	200	85	90	∅0.04mm opaque object	2m	R25mm	FT-H35-M2	
	350°C Sleeve 60mm 	550 330 280	85	90				Fiber R25mm Sleeve R10 mm R0.394 in	FT-H35-M2S6	
	Allows flexible wiring, 200°C Lens mountable 	420 310 180 140	100	40	50	∅0.02mm opaque object	1m	R10 mm R0.394 in	FT-H20W-M1	
	200°C Lens mountable 	750 550 320 280	200	85	90	∅0.04mm opaque object	1m		FT-H20-M1	
	130°C Lens mountable (FX-LE2 only) 	1200 880 550 440	300	150	155	∅0.06mm opaque object	2m	R25mm	FT-H13-FM2	
Special	Heat-resistant • Joint Lens mountable (FX-LE1) 	530 390 225 200	140	60	60	∅0.12mm opaque object	200mm (Note 4) 300mm (Note 4) 500mm (Note 4)	Heat-resistant fiber R18mm (Note 5)	FT-H20-J20-S (Note 6)	
		Side-view 	840 550 370 280	200	90	90	∅0.16mm opaque object		500mm (Note 4) 800mm (Note 4)	FT-H20-J30-S (Note 6)
	Easy mounting • Rectangular head SEMI S2 compliant W7 x H15 x D13 		3500 3500 3000 1500	1000	500	530	∅4mm opaque object		2m	R25mm
		Heat-resistant 115°C 	3500 3500 1800 1350	900	450	480	∅0.2mm opaque object		2m (Note 7)	R30mm
	3500 3500 2000 1500	1000	500	530	FT-L80Y					
Side-view 	1000 800 500 400	280	120	140	FT-V80Y					
Vacuum-resistant	300°C Lens mountable (FV-LE1/SV2 only) 	350 250 150 125	90	50	40	∅0.03mm opaque object	1m	R1mm	FT-H30-M1V-S	

Optical Fibers for FX 300 Series

Retroreflective type



The **FX-305** and **FX-301(-HS)** have different sensing modes.
FX-305: H-SP, FAST, STD, STDF, LONG, U-LG (no S-D mode)
FX-301(-HS): S-D, H-SP (Note 1), FAST, STD, LONG (no STDF or U-LG mode)

Type	Shape of fiber head (mm)	Sensing range (mm) (Notes 2, 3)	<ul style="list-style-type: none"> ■ U-LG ■ LONG ■ STDF ■ STD 	<ul style="list-style-type: none"> ■ FAST ■ H-SP ■ S-D 	Min. sensing object (Note 4)	Fiber cable length ✂ : Free-cut	Bending radius	Model no.		
Sharp bending With polarizing filters	W9.5 x H5.2 x D15	<ul style="list-style-type: none"> 100 to 910 100 to 730 100 to 600 100 to 520 (Note 3) 	<ul style="list-style-type: none"> 100 to 460 		ø0.3mm opaque object	✂ 2m	<ul style="list-style-type: none"> R1 mm R0.039 in 	FR-WKZ11		
	W30 x H30 x D0.5	Cannot use	Cannot use		Horizontal: ø5.5mm opaque object	✂ 2m	<ul style="list-style-type: none"> R10 mm R0.394 in 	FR-KZ21		
Narrow beam	Top sending W9.5 x H5.2 x D21	<ul style="list-style-type: none"> 200 	<ul style="list-style-type: none"> 200 200 200 		Vertical: ø0.06mm opaque object	✂ 2m			FR-KZ21E	
	Side sending W10.6 x H28 x D10.1	<ul style="list-style-type: none"> 200 200 200 					Water mapping W7.5 x H2.2 x D11.2 W4 x H2 x D21.5		<ul style="list-style-type: none"> 15 to 370 15 to 330 15 to 240 15 to 210 	<ul style="list-style-type: none"> 15 to 170 15 to 80 15 to 90

Reflective type



The **FX-305** and **FX-301(-HS)** have different sensing modes.
FX-305: H-SP, FAST, STD, STDF, LONG, U-LG (no S-D mode)
FX-301(-HS): S-D, H-SP (Note 1), FAST, STD, LONG (no STDF or U-LG mode)

Type	Shape of fiber head (mm)	Sensing range (mm) (Notes 1, 2)	<ul style="list-style-type: none"> ■ U-LG ■ LONG ■ STDF ■ STD 	<ul style="list-style-type: none"> ■ FAST ■ H-SP ■ S-D 	Min. sensing object (Note 3)	Fiber cable length ✂ : Free-cut	Bending radius	Model no.
Threaded type	M6	M6	<ul style="list-style-type: none"> 600 480 280 220 	<ul style="list-style-type: none"> 160 85 75 	ø0.02mm gold wire	✂ 2m	R25mm	FD-B8
		Coaxial M6	<ul style="list-style-type: none"> 410 310 200 140 	<ul style="list-style-type: none"> 100 55 47 				FD-FM2
		Sleeve 90mm M6	<ul style="list-style-type: none"> 370 270 	<ul style="list-style-type: none"> 85 45 39 			Fiber R25mm Sleeve	FD-FM2S
		Sleeve 40mm M6	<ul style="list-style-type: none"> 170 110 				<ul style="list-style-type: none"> R10 mm R0.394 in 	FD-FM2S4
		M6	<ul style="list-style-type: none"> 250 190 110 90 	<ul style="list-style-type: none"> 60 25 32 			<ul style="list-style-type: none"> R1 mm R0.039 in 	FD-W8
		M6	<ul style="list-style-type: none"> 300 220 130 100 	<ul style="list-style-type: none"> 70 30 35 			<ul style="list-style-type: none"> R4 mm R0.157 in Flexible 	FD-P80
		M6	<ul style="list-style-type: none"> 270 185 100 80 	<ul style="list-style-type: none"> 60 30 35 			<ul style="list-style-type: none"> R10 mm R0.394 in 	FD-P81X
	Elbow	M6	<ul style="list-style-type: none"> 240 185 110 85 	<ul style="list-style-type: none"> 60 25 30 			ø0.02mm gold wire	✂ 2m

Pliable fibers (flexible and sharp bending fibers) are marked with light red in the table.

Standard Fibers

Optical Fibers for FX 300 Series

Reflective type



The **FX-305** and **FX-301(-HS)** have different sensing modes.
FX-305: H-SP, FAST, STD, STDF, LONG, U-LG (no S-D mode)
FX-301(-HS): S-D, H-SP (Note 1), FAST, STD, LONG (no STDF or U-LG mode)

Type	Shape of fiber head (mm)	Sensing range (mm) (Notes 1, 2)	<ul style="list-style-type: none"> ■ U-LG ■ LONG ■ STDF ■ STD 	<ul style="list-style-type: none"> ■ FAST ■ H-SP ■ S-D 	Min. sensing object (Note 3)	Fiber cable length ✂ : Free-cut	Bending radius	Model no.		
Threaded type	M4		370 270 170 110	85 45 39	∅0.02mm gold wire	✂ 2m	R25mm	FD-T80		
	M4						R25mm	FD-NFM2		
	Sleeve 90 mm		140 90 60 45	35 16 16			Fiber R25mm Sleeve	FD-NFM2S		
	Sleeve 40mm						R10 mm R0.394 in	FD-NFM2S4		
	Sleeve 40mm 1.575 in		40 30 18 15	12 4.5 5			Fiber R1 mm R0.039 in Sleeve R10 mm R0.394 in	FD-W44		
	M4		250 190 110 90	60 25 32			R1 mm R0.039 in	FD-WT8		
	Minute objects can be detected due to the small spot beam. Coaxial • Lens mountable		85 65 37 32	25 10 11			R2 mm R0.079 in	FD-WG4		
	M4		150 110 65 55	42 15 19			R25mm	FD-G4		
	M4		130 90 55 45	30 13 16			R4 mm R0.157 in Flexible	FD-P60		
	Small diameter		140 90 60 45	35 16 16			∅0.02mm gold wire	✂ 2m	R25mm	FD-T40
	M3		40 30 18 15	12 4.5 5					R1 mm R0.039 in	FD-WT4
	M3		50 36 20 18	14 5.5 6					R4 mm R0.157 in Flexible	FD-P40
	Lens mountable (FX-MR3, FX-MR6)		150 110 65 55	42 15 19					R25mm	FD-G6
	Lens mountable (FX-MR3, FX-MR6)		150 90 48 45	35 12 20					1m (Note 4)	R10 mm R0.394 in
Coaxial • Lens mountable (FX-MR3, FX-MR6)		50 38 25 18	14 5 6	R25mm	FD-EG1					
Coaxial • Lens mountable (FX-MR3, FX-MR6)		40 25 14 12	9 3 5	∅0.04mm gold wire	500mm	R10 mm R0.394 in			FD-EG2	
Coaxial • Lens mountable (FX-MR3, FX-MR6)		20 15 9 8	5 2.5 3			FD-EG3				
Sleeve part cannot be bent.		6.5 5 3 3	2 Cannot use Cannot use	∅0.02mm gold wire	1m	R25mm			FD-EN500S1	
Coaxial		50 38 20 18	14 5 6			FD-ENM1S1				

Pliable fibers (flexible and sharp bending fibers) are marked with light red in the table.

Optical Fibers for FX 300 Series

Reflective type



The **FX-305** and **FX-301(-HS)** have different sensing modes.
FX-305: H-SP, FAST, STD, STDF, LONG, U-LG (no S-D mode)
FX-301(-HS): S-D, H-SP (Note 1), FAST, STD, LONG (no STDF or U-LG mode)

Type	Shape of fiber head (mm)	Sensing range (mm) (Notes 1, 2)	<ul style="list-style-type: none"> ■ U-LG ■ LONG ■ STDF ■ STD 	<ul style="list-style-type: none"> ■ FAST ■ H-SP ■ S-D 	Min. sensing object (Note 3)	Fiber cable length ✂ : Free-cut	Bending radius	Model no.	
Cylindrical type	 ø3 Coaxial ø3				ø0.02mm gold wire	2m	R25mm	FD-S80	
					ø0.02mm gold wire	2m	R1 mm R0.039 in	FD-WS8	
					ø0.02mm gold wire	2m	R2 mm R0.079 in	FD-WSG4	
					ø0.02mm gold wire	2m	R4 mm R0.157 in Flexible	FD-P50	
	 ø2.5				ø0.02mm gold wire	2m	R25mm	FD-SNFM2	
	 ø1.5				ø0.02mm gold wire	1m	R4 mm R0.157 in Flexible	FD-P2	
	Ultra small diameter	 ø1.5 Sleeve part cannot be bent.				ø0.02mm gold wire	1m	R10 mm R0.394 in	FD-E12
		 Coaxial ø3 ø0.65 Sleeve part cannot be bent.				ø0.02mm gold wire	1m	R25mm	FD-E22
	Side-view	 ø3 ø1.5 Sleeve part cannot be bent.				ø0.02mm gold wire	2m	R25mm	FD-V41
		 ø3 ø2 Sleeve part cannot be bent.				ø0.02mm gold wire	2m	R1 mm R0.039 in	FD-WV42
Rectangular	 ø5 Sleeve part cannot be bent.				ø0.02mm gold wire	2m	R25mm	FD-SFM2SV2	
					ø0.02mm gold wire	2m	R25mm	FD-L46	
	Glass substrate detection • Mapping	 W25 × H7.3 × D30				ø0.3mm gold wire	4m	R25mm	FD-L46
		 W20 × H29 × D3.8				(LCD glass)	3m	R4 mm R0.157 in	FD-L45
	Glass substrate detection • Alignment	 W17 × H29 × D3.8				(LCD glass)	2m	R4 mm R0.157 in	FD-L43
		 W12 × H19 × D3				ø0.03mm gold wire	2m	R10 mm R0.394 in	FD-L44
	Convergent reflective type	 W24 × H21 × D4				ø0.06mm gold wire	2m	R10 mm R0.394 in	FD-L41
		 W6 × H18 × D14				ø0.02mm gold wire	2m	R10 mm R0.394 in	FD-L4
	Convergent reflective type	 W7.2 × H7.5 × D2				ø0.03mm copper wire	1m	R1 mm R0.039 in	FD-WL48
		 W7.2 × H7.5 × D2				ø0.03mm copper wire	1m	R1 mm R0.039 in	FD-WL48

Pliable fibers (flexible and sharp bending fibers) are marked with light red in the table.

Standard Fibers

Optical Fibers for FX 300 Series

Reflective type



FX-305 / FX-301 (Red LED type) sensing range (Note 1)

The FX-305 and FX-301(-HS) have different sensing modes.
FX-305: H-SP, FAST, STD, STDF, LONG, U-LG (no S-D mode)
FX-301(-HS): S-D, H-SP (Note 1), FAST, STD, LONG (no STDF or U-LG mode)

Type	Shape of fiber head (mm)	Sensing range (mm) (Notes 1, 2)	<ul style="list-style-type: none"> ■ U-LG ■ LONG ■ STDF ■ STD 	<ul style="list-style-type: none"> ■ FAST ■ H-SP ■ S-D 	Min. sensing object (Note 3)	Fiber cable length ✂ : Free-cut	Bending radius	Model no.	
Rectangular	Front sensing W10 × H7 × D2	<ul style="list-style-type: none"> ■ 1 to 50 ■ 1.5 to 34 ■ 2 to 24 ■ 3 to 17 	<ul style="list-style-type: none"> ■ 3 to 10 ■ Cannot use ■ Cannot use 		∅0.16mm copper wire	✂ 1m		FD-WZ4	
	Fiber bending type W2 × H10 × D10	<ul style="list-style-type: none"> ■ 1 to 70 ■ 1 to 46 ■ 1 to 32.2 ■ 2.5 to 23 	<ul style="list-style-type: none"> ■ 2.5 to 15 ■ 3 to 7 ■ 3 to 7 					FD-WZ4HB	
	Front sensing W14 × H7 × D3.5	<ul style="list-style-type: none"> ■ 200 ■ 120 ■ 1 to 84 ■ 1 to 60 	<ul style="list-style-type: none"> ■ 1.5 to 35 ■ 2.5 to 18 ■ 2.5 to 18 		∅0.03mm gold wire	✂ 2m		FD-WZ7	
	Fiber bending type W3.5 × H14 × D11	<ul style="list-style-type: none"> ■ 0.5 to 270 ■ 0.5 to 180 ■ 1 to 126 ■ 1 to 90 	<ul style="list-style-type: none"> ■ 1 to 70 ■ 1 to 35 ■ 1 to 35 				R1 mm R0.039 in	FD-WZ7HB	
Special	Long sensing range • Rectangular head W5.2 × H9.5 × D15	<ul style="list-style-type: none"> ■ 20 to 660 ■ 20 to 480 ■ 20 to 300 ■ 20 to 230 	<ul style="list-style-type: none"> ■ 20 to 170 ■ 25 to 90 ■ 25 to 100 		∅0.3mm copper wire	✂ 2m	R1 mm R0.039 in	FD-WKZ1	
	Wide beam W7 × H15 × D30	<ul style="list-style-type: none"> ■ 230 ■ 200 ■ 150 ■ 150 	<ul style="list-style-type: none"> ■ 100 ■ 45 ■ 50 		∅0.02mm gold wire	✂ 2m	R25mm	FD-A15	
	Array	Top sensing W5 × H20 × D20	<ul style="list-style-type: none"> ■ 290 ■ 220 	<ul style="list-style-type: none"> ■ 78 ■ 35 ■ 39 		∅0.02mm gold wire	✂ 2m	R25mm	FD-AFM2
		Side sensing W5 × H20 × D20	<ul style="list-style-type: none"> ■ 135 ■ 110 						FD-AFM2E
	Liquid level sensing	Contact type ∅6	—	—		(Liquid)	✂ 2m (Note 5)	Protective tube R40mm Fiber R15mm	FD-F8Y
		Mountable on pipe • Standard W25 × H13 × D20	Applicable pipe diameter: Outer dia. ∅6 to ∅26mm transparent pipe PVC (vinyl chloride), fluorine resin, polycarbonate, acrylic, glass, wall thickness 1 to 3mm				✂ 2m	R10 mm R0.394 in	FD-F41
Mountable on pipe • For PFA, wall thickness 1 mm pipe W25 × H13 × D20		Applicable pipe diameter: Outer dia. ∅6 to ∅26mm transparent pipe PFA (fluorine resin) or equivalently transparent pipe, wall thickness 1mm						FD-F4	
Mountable on pipe SEMI S2 compliant W23 × H20 × D17		Applicable pipe diameter: Outer dia. ∅3 to ∅10mm transparent pipe PFA (fluorine resin) or equivalently transparent pipe, wall thickness 0.3 to 1mm			(Liquid)	✂ 2m	Protective tube R20mm Fiber R4 mm R0.157 in	FT-F902	
Liquid leak detection	SEMI S2 compliant W20 × H30 × D10	—	—		(Liquid)	✂ 5m (Protective tube: 3m)	Protective tube R20mm Fiber R4 mm R0.157 in	FD-F705	

Pliable fibers (flexible and sharp bending fibers) are marked with light red in the table.

Optical Fibers for FX 300 Series

Reflective type



The FX-305 and FX-301(-HS) have different sensing modes.
FX-305: H-SP, FAST, STD, STDF, LONG, U-LG (no S-D mode)
FX-301(-HS): S-D, H-SP (Note 1), FAST, STD, LONG (no STDF or U-LG mode)

Type	Shape of fiber head (mm)	Sensing range (mm) (Notes 1, 2)	■ U-LG ■ LONG ■ STDF ■ STD	■ FAST ■ H-SP ■ S-D	Min. sensing object (Note 3)	Fiber cable length ✂ : Free-cut	Bending radius	Model no.		
Special	Heat-resistant	350°C • Coaxial 				ø0.02mm gold wire	2m	R25mm	FD-H35-M2	
		350°C • Sleeve 60mm 	■ 300 ■ 270 ■ 150 ■ 140	■ 100 ■ 35 ■ 47	Fiber R25mm Sleeve R10 mm R0.394 in			FD-H35-M2S6		
		200°C • Coaxial 					1m	R25mm	FD-H20-M1	
		350°C • Sleeve 90mm 	■ 190 ■ 160 ■ 80 ■ 80	■ 57 ■ 20 ■ 26	Fiber R25mm Sleeve R10 mm R0.394 in			FD-H35-20S		
		200°C • Coaxial 	■ 300 ■ 270 ■ 150 ■ 140	■ 100 ■ 35 ■ 47				FD-H20-21		
	Vacuum-resistant	300°C • Glass substrate detection Convergent reflective type 	■ 0 to 20 ■ 0 to 15 ■ 0 to 10 ■ 0 to 10	■ 1 to 8 Cannot use ■ 2 to 6			ø0.8mm gold wire	2m	R25mm	FD-H30-L32
		180°C • Glass substrate detection Convergent reflective type 	■ 0 to 20 ■ 0 to 15 ■ 0 to 10 ■ 0 to 10	■ 1 to 8 Cannot use ■ 2 to 6					✂ 2m	
		130°C • Coaxial 	■ 410 ■ 310 ■ 200 ■ 140	■ 100 ■ 55 ■ 47				FD-H13-FM2		
		300°C • Rectangular head W9.5 × H5.2 × D15 	■ 20 to 300 ■ 20 to 200 ■ 20 to 150 ■ 25 to 130	■ 30 to 100 Cannot use Cannot use				1m		R18mm
		300°C • Glass substrate detection Convergent reflective type 	■ 0 to 11 ■ 0 to 8 ■ 1.5 to 6 ■ 1.5 to 5	■ 2 to 4 Cannot use Cannot use				3m		FD-H30-L32V-S

Accessories (attached with fibers)

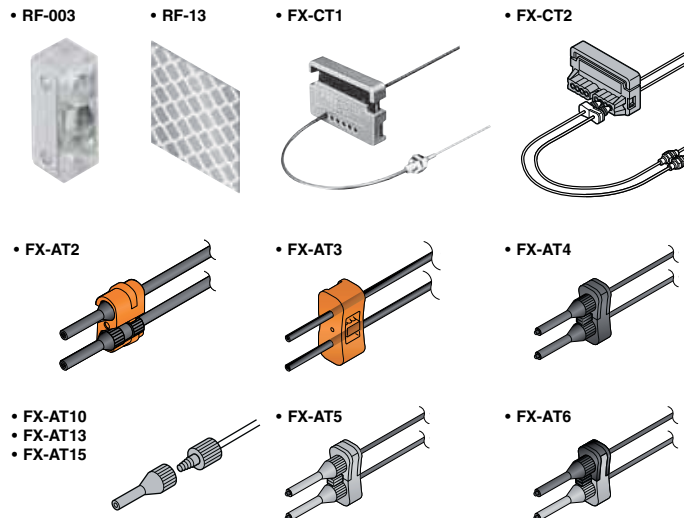

- RF-003 (FR-KZ21/KZ21E exclusive reflector)
- RF-13 (Reflective tape)
- FX-CT1 (Fiber cutter)
- FX-CT2 (Fiber cutter)
- FX-AT2 (Attachment for fixed-length fiber, Orange)
- FX-AT3 (Attachment for ø2.2mm fiber, Transparent orange)
- FX-AT4 (Attachment for ø1mm fiber, Black)
- FX-AT5 (Attachment for ø1.3mm fiber, Gray)
- FX-AT6 (• Attachment for ø1mm / ø1.3mm mixed fiber, Black / Gray)



If connecting to the FX2 / FX3 series

- FX-AT10 (Attachment for ø1mm fiber)
- FX-AT13 (Attachment for ø1.3mm fiber)
- FX-AT15 (• Attachment for ø1mm / ø1.3mm mixed fiber)

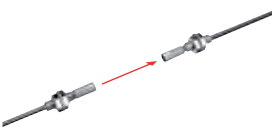
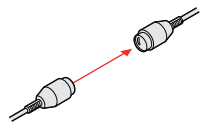
Accessories for the FX 300 Series

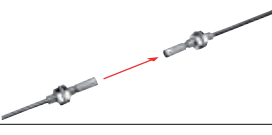
Accessories for retroreflective fiber optics					
Figure	Description	Fiber optics	Sensing range*	Sensing range**	Model no.
	Effective distance expanded 5 times or more; Ambient temperature: -60°C to +350°C	FT-B8	2500	3500	FX-LE1
		FT-FM2	3500	3500	
		FT-T80	3500	3500	
		FT-R80	2300	3500	
		FT-W8	2900	3500	
		FT-P80	3500	3500	
		FT-P60	3500	3500	
		FT-H35M2	2000	3500	
		FT-H20WM1	1300	1600	
		FT-H20WM2	1300	3500	
		FT-H20M1	1600	1000	
	Tremendously increases the sensing range with large diameter lenses Ambient temperature: -60°C to +350°C	FT-B8	3500	3500	FX-LE2
		FT-FM2	3500	3500	
		FT-T80	3500	3500	
		FT-R80	3500	3500	
		FT-W8	2900	3500	
		FT-P80	3500	3500	
		FT-P60	3500	3500	
		FT-H35M2	3500	3500	
		FT-H20WM1	1600	1600	
		FT-H20WM2	3500	1600	
		FT-H20M1	1600	1600	
	Beam axis is bent by 90° Ambient temperature: -60°C to +350°C	FT-B8	530	1100	FX-SV1
		FT-FM2	600	1200	
		FT-T80	600	1200	
		FT-W8	450	900	
		FT-P80	600	1200	
		FT-P60	300	650	
		FT-H35M2	280	550	
		FT-H20WM1	140	310	
		FT-H20WM2	140	310	
FT-H20M1	280	550			
	Sensing range increases by 15 times or more Ambient temperature: -40°C to +120°C	FT-6V	2700	3500	FX-LE1
		FT-60V	1450	3500	

* Refers to response time "Standard"

** Refers to response time "Ultralong"

Accessories for the FX Series

Accessories for retroreflective fiber optics					
Figure	Description	Effective distance (with FX-301)			Model no.
		Fiber	Screw-in depth	Spot diameter	
	Pinpoint spot of Ø 0.5mm enables detection of minute objects or small marks Applicable fibers: FD-WG4 / FD-G4 Ambient temperature: -40°C to +70°C	FD-WG4	6mm ± 1mm	Ø 0.5mm	FX-MR1
		FD-G4	6mm ± 1mm	Ø 0.5mm	

Figure	Description	Effective distance (with FX-301)				Model no.
		Fiber	Screw-in depth	Sensing width	Spot diameter	
	The spot diameter is adjustable from 0.7mm to Ø2mm according to how far the fiber is screwed in. Ambient temperature: -40°C to +70°C	FD-WG4	7mm	approx. 18.5mm	Ø 0.7mm	FX-MR2
			12mm	approx. 27mm	Ø 1.2mm	
			14mm	approx. 43mm	Ø 2.0mm	
		FD-G4	7mm	approx. 18.5mm	Ø 0.7mm	
			12mm	approx. 27mm	Ø 1.2mm	
			14mm	approx. 43mm	Ø 2.0mm	

Figure	Description	Effective distance (with FX-301)				Model no.
		Fiber	Screw-in depth	Sensing width	Spot diameter	
	FX-MR2 is converted into a side sensing type and can be mounted in a very small space. Ambient temperature: -40°C to +70°C	FD-WG4	8mm	approx. 13mm	Ø 0.5mm	FX-MR5
			10mm	approx. 15mm	Ø 0.8mm	
			14mm	approx. 30mm	Ø 3.0mm	
		FD-G4	8mm	approx. 13mm	Ø 0.5mm	
			10mm	approx. 15mm	Ø 0.8mm	
			14mm	approx. 30mm	Ø 3.0mm	

Figure	Description	Effective distance (with FX-301)			Model no.
		Fiber	Screw-in depth	Spot diameter	
	Extremely fine spot of approx. Ø 0.3mm achieved Ambient temperature: -40°C to +70°C	FD-WG4	7.5mm ± 0.5mm	Ø 0.5mm	FX-MR3
		FD-G4	7.5mm ± 0.5mm	Ø 0.5mm	
		FD-EG1	7.5mm ± 0.5mm	Ø 0.3mm	
		FD-EG3	7.5mm ± 0.5mm	Ø 0.15mm	

Figure	Description	Effective distance (with FX-301)			Model no.
		Fiber	Screw-in depth	Spot diameter	
	Extremely fine spot of approx. Ø 0.3mm achieved Ambient temperature: -40°C to +70°C	FD-WG4	7mm ± 0.5mm	Ø 0.4mm	FX-MR6
		FD-G4	7mm ± 0.5mm	Ø 0.4mm	
		FD-EG1	7mm ± 0.5mm	Ø 0.2mm	
		FD-EG3	7mm ± 0.5mm	Ø 0.1mm	

FD-L40

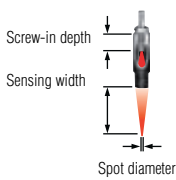
FD-L40

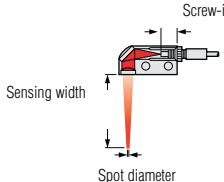

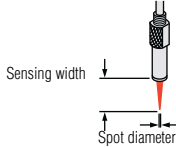
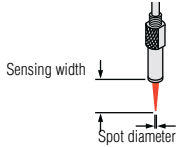
Fibers for liquid crystal display industry

Features

Mapping Fiber

FD-L46

The adoption of a unique large lens allows even thin glass substrates to be sensed directly from the side. In addition, due to the wide sensing range ($25 \pm 12.5\text{mm}$), stable mapping is possible even if glass substrates are in irregular positions.

Variety of glass substrates

FD-L46

Large light amounts can be obtained for a variety of glass edge shapes such as R surfaces and C surfaces, so that accurate mapping of glass substrates inside cassettes is possible. Glass that has received black or yellow masking can also be sensed in addition to clear glass.

Alignment fiber

FD-L43 / FD-L45

Increases in size of glass substrates mean greater amounts of flexure, but a single fiber can sense glass even if horizontal flexure is within $\pm 8^\circ$ (FD-L45% $\pm 6^\circ$).

A sensing range of 3 to 17mm (FD-L45: 10 to 25mm) and a positioning error of 0.2mm or less makes higher precision sensing possible

Seating confirmation fiber

FD-L44 / FD-L44S / FD-WL48

Long sensing range of 0 to 7mm for seating confirmation. Sensing is even possible if absorption pads are present.

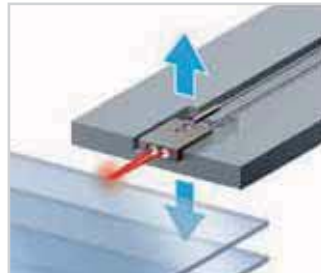
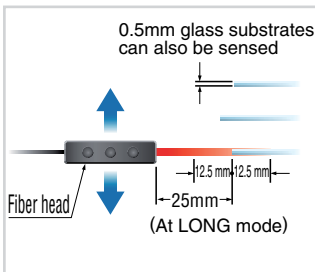

Technical Specifications

Applicable amplifiers:	FX-100/301/305/311/411 series red LED type
	FD-L46 12.5 to 37.5mm (LONG mode)
	FD-L43 0 to 23mm (STD mode)
	FD-L44 0 to 7mm (LONG mode)
Sensing range (Note 1):	FD-L44S 0 to 4.5mm (LONG mode)
	FD-L45 0 to 36mm (LONG mode)
	FD-WL48 0.5 to 7.5mm (LONG mode)
Allowable bending radius:	FD-L46 R25mm or more, FD-L45/FD-L43 R4mm or more
	FD-L44(S) R10mm or more, FD-WL48 R1mm or more
Fiber cable length:	FD-L46 4m (free-cut), FD-L43/44(S) 2m (free-cut)
	FD-L45 3m (free-cut), FD-WL48 1m (free-cut)

FT/FD-V

FT/FD-V



Vacuum resistant fiber

Features

Usable in high temperatures of 300°C and vacuum

Highly reliable sensing of objects is possible even after high-temperature processing used in FPD manufacturing.

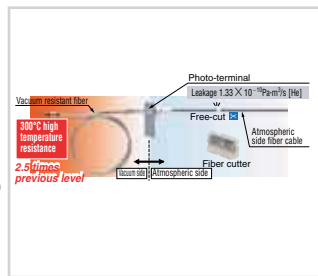

Compact routing

We have realized a bending radius of R18mm.

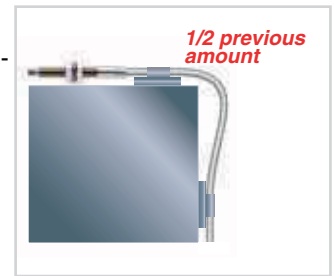

Highly durable

It can be bent over 100,000 times (at R20mm).

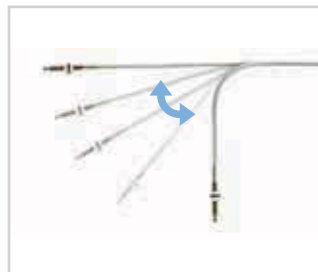

Technical Specifications

Applicable amplifiers:	FX-100/301/305/311/411 series
Sensing range (at LONG mode of red LED type):	FT-H30-M1V 250mm FD-H30-KZ1V 20 to 200mm FD-H30-L32V 0 to 8mm
Allowable bending radius:	FD-L46 R25mm or more, FD-L45/FD-L43 R4mm or more FD-L44(S) R10mm or more, FD-WL48 R1mm or more
Fiber cable length:	FD-L46 4m (free-cut), FD-L43/44(S) 2m (free-cut) FD-L45 3m (free-cut), FD-WL48 1m (free-cut)

EX-F70/F60



High-speed detection of even small liquid leaks

Features

■ Reliable detection

The unique effect of capillarity enables reliable detection of small leaks and viscous liquids.

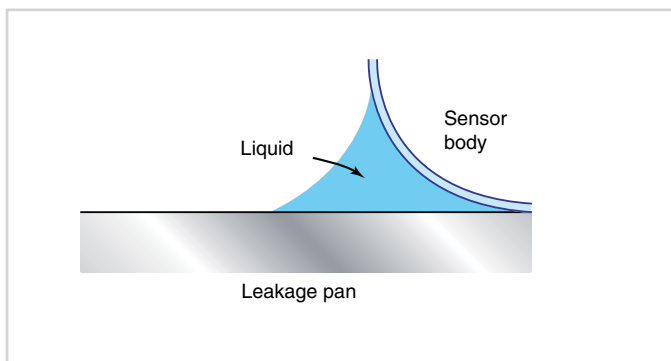

■ PFA enclosure gives excellent chemical resistance

Accurate sensing can be obtained even if there are leaks of chemicals such as sulfuric acid, hydrochloric acid or ammonia

■ Safe design

If the sensor is installed incorrectly, the cable breaks or a sensor problem occurs, the same output is used as for a liquid leak. This guards against human error in setup that might occur during maintenance.

■ Compact, space-saving

The EX-F70 series is a slim (10mm) side mounting sensor. The EX-F60 series is compact at 26×19×9mm (W×H×D), so that it can be used even in narrow spaces.

Technical Specifications

Sensing object:	EX-F7□ Water, Fluorinert™ EX-F6□ Agent, such as sulfuric acid, hydrochloric acid, phosphoric acid or ammonia etc.
Supply voltage:	12 to 24VDC±10%
Output:	EX-F7□/F6□ NPN open-collector transistor EX-F7□/F6□-PNP open-collector transistor
Response time:	50ms or less
Emitting element:	Infrared LED (non-modulated)

FR-KV1

Wafer mapping fiber

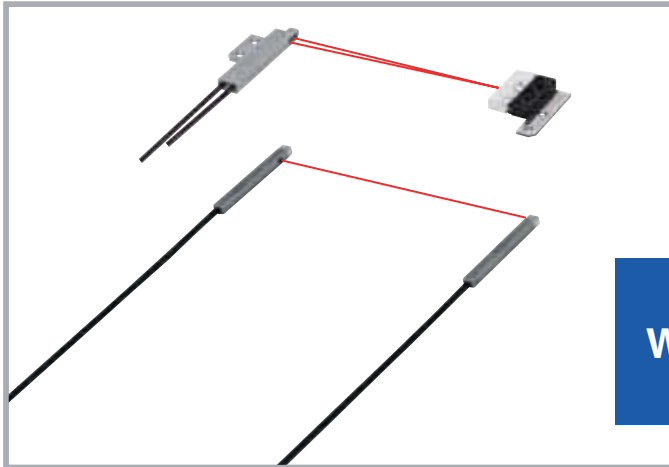

Features

■ Retroreflective type: new concept

A 2.0mm fiber head and an ultrathin 2.2mm reflector allow these sensors to be mounted even in thin robot hands. Since they are retroreflective type fibers, the amount of wiring needed can be reduced, and the robot hands require less processing and so can be kept strong. A heat-resistant type that can resist heat of +105°C is also available.

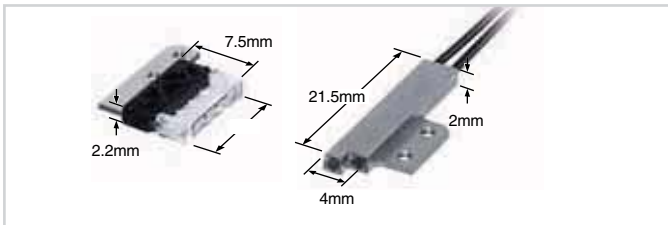

■ Thru-beam type: ultra compact size

The ultra compact size of 2×1.52×20mm (W×H×D) means that mounting is possible even in places such as robot hands where space is limited. Furthermore, a heat-resistant type that can resist heat of +105°C is also available.

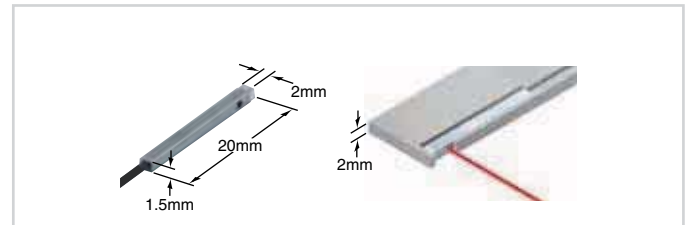

FT-KV1 fiber can be embedded into a plate with a thickness of 2mm.

Technical Specifications

Applicable amplifiers:	FX-100/301/305/311/411 series
Sensing range: (at LONG mode of red LED type)	Retroreflective type 15 to 330mm (Note: thru-beam type 500mm)
Allowable bending radius:	R10mm or more
Fiber cable length:	2m (free-cut)

FD-F705

FD-F705



A new slim fiber sensor ideal for sensing chemical leaks

Features

■ Reliable detection

The unique effect of capillarity enables reliable detection of small leaks and viscous liquids.

■ Compact, space-saving

This slim (10mm) side-mounting sensor is especially well suited for use in confined spaces.

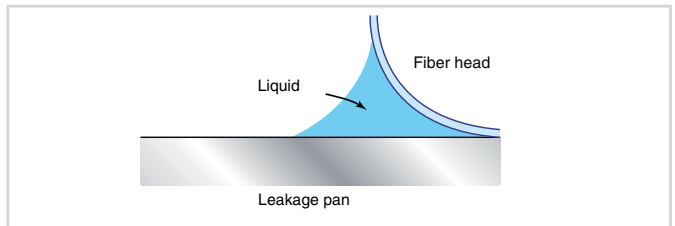
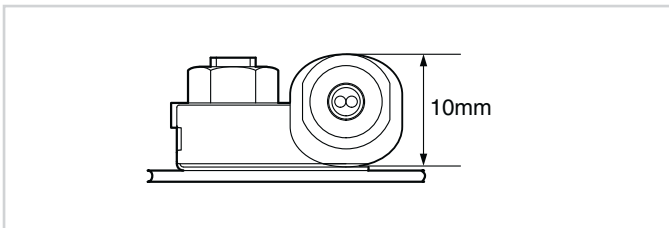

■ Ideal for chemicals and volatile materials

This fiber type sensor is safe to use with volatile materials (SEMI S2 compliant). The PFA (fluorine resin) fiber head makes it ideal for use with chemicals.

Technical Specifications

Applicable amplifiers:	FX-301-F, FX-301P-F
Sensing object:	Liquid
Fiber cable length:	5m (free-cut)
Protective tube length:	3m
Dimensions (W×H×D):	20×30×10mm

Notes: 1) Fluorinert™ is the worldwide TradeMark of 3M.

FT-F902

FT-F902

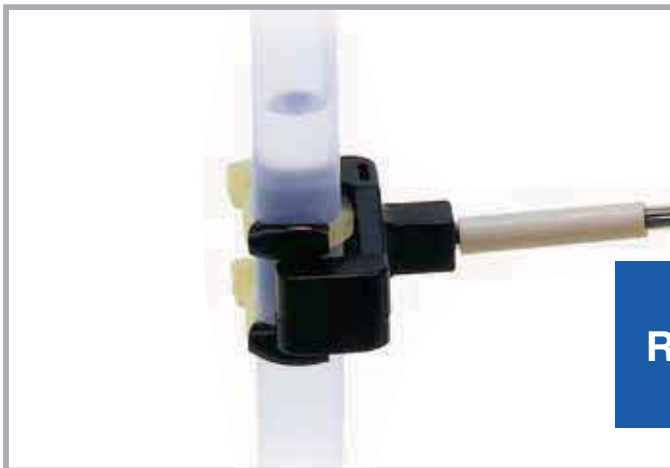

Reliably detect liquid in pipes

Features

■ Safe fiber type sensor

Because it is a fiber sensor, it is safe to use in dangerous areas where there is a risk of fire or explosion. It meets the stringent demands for higher safety levels placed by international standards including SEMI S2.

■ Easy to use and reliable detection

Even when shape and thickness of the pipe vary, this sensor uses a method where the beam axis follows the diameter of the pipe, and so, when compared to conventional methods, the shape and thickness of the pipe have no influence on the performance of this sensor.

■ Reliable detection not affected by bubbles or droplets

Problems encountered by conventional pipe-mountable sensors, such as bubbles, droplets or liquid leakage, have been solved using the latest optical fiber techniques.

■ Worry-free design that doesn't overlook liquid-absent condition and sensor malfunction

When liquid is present in the pipe, the lens effect of the liquid condenses the beam so that the sensor is in beam receiving condition.

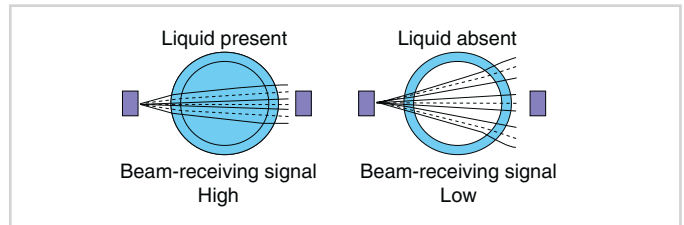

Technical Specifications

Applicable amplifiers:	FX-301-F, FX-301P-F
Sensing object:	Liquid
Applicable pipe diameter:	Outer dia. \varnothing 3.0 to \varnothing 10.0mm
Fiber cable length:	2m (free-cut)
Protective tube length:	1m
Dimensions (W×H×D):	23×17×20mm

M18-L



Thru-beam and retroreflective laser sensors



Features

■ Great lineup of 48 models

The M18-L series offers all optical functions in an M18 housing. The visible laser light spot makes the sensor simple to align. It is easy to install and requires little space due to its ultra-compact size.

- Available types: thru-beam laser sensor up to 60m, retroreflective type up to 16m, diffuse reflective type up to 350mm
- Complete range of optic functions, laser class 1
- Flat plastic tubular housing for improved versatility, or metal cylindrical housing
- Cable or M12 connection
- NPN or PNP
- Radial and axial versions

Typical Applications

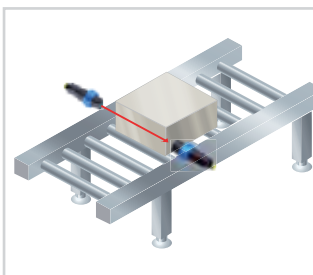

Packaging

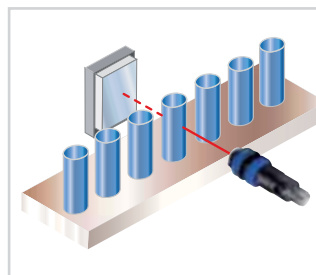

Precise object detection

Technical Specifications

NPN-Output	M18-LT5000- [R]-[M/P]-[J]	M18-LT6000- [A]-[M/P]-[J]	M18-LP0900- [R]-[M/P]-[J]	M18-LP1600- [A]-[M/P]-[J]
PNP-Output	M18-LT5000- [R]-[M/P]- PN-[J]	M18-LT6000- [A]-[M/P]- PN-[J]	M18-LP0900- [R]-[M/P]- PN-[J]	M18-LP1600- [A]-[M/P]- PN-[J]
Sensor type	Thru-beam		Retroreflective	
	Radial	Axial	Radial	Axial
Maximum operation distance	50m	60m	9m	16m
Sensing range	0 to 50m	0 to 60m	0.1 to 9m	0.1 to 16m
Sensing object	Metal, black			
	Ø 10mm		Ø 5mm	
Detectable target	Opaque		Opaque, translucent	
Hysteresis	-			
Response time	333µs			
Output	Max. 100mA			
Emitting element	Red semiconductor laser, 650nm (class 1)			
Current consumption without load	Emitter: max. 35mA Receiver: max. 30mA		Max. 35mA	
	Metal version: nickel-plated brass Plastic version: PBT Lens: PMMA			
Material	Metal version: nickel-plated brass Plastic version: PBT Lens: PMMA			
Protection	IP67			
Dimensions (H×W×D)	Cable type: M18×89mm	Cable type: M18×77mm	Cable type: M18×89mm	Cable type: M18×77mm
	Connector type: M18×93.5mm	Connector type: M18×81.5mm	Connector type: M18×93.5mm	Connector type: M18×81.5mm
Connection	Cable 2m or M12 connector			
Supply voltage	10 to 30VDC			
Ambient temperature	Operation: -10 to +50°C, storage: -25 to +70°C			
Weight	Cable type: Emitter and receiver each approx. 75g		Cable type: approx. 75g (plastic version) or approx. 110g (metal version)	
	Connector type: Emitter and receiver each approx. 25g		Connector type: Approx. 25g (plastic version) or approx. 60g (metal type)	
[R] = Radial • [A] = Axial [P] = Plastic [M] = Metal • [PN] = PNP [J] = M12 connector				

*Reflector not included



Reflective laser sensors

Technical Specifications

NPN-output	M18-LD0025-R-[M/P]-[J]	M18-LD0035-A-[M/P]-[J]
PNP output	M18-LD0025-R-[M/P]-PN-[J]	M18-LD0035-A-[M/P]-PN-[J]
Sensor type	Reflective	
	Radial	Axial
Maximum operation distance	250mm	350mm
Sensing range	0 to 250mm	0 to 350mm
Spot diameter	0.3mm at 50mm	
Sensing object	Paper, white	
	100×100mm	200×200mm
Detectable target	Opaque, translucent	
Hysteresis	<1%	
Response time	333µs	
Output	Max. 100mA	
Emitting element	Red semiconductor laser, 650nm (class 1)	
Current consumption without load	Max. 35mA	
	Metal version: nickel-plated brass	
	Plastic version: PBT Lens: PMMA	
Protection	IP67	
Dimensions (Ø × L)	M18 × 81.5mm	
Connection	Cable 2m or M12 connector	
Supply voltage	10 to 30V DC	
Ambient temperature	Operation: -10 to +50°C, storage: -25 to +70°C	
Weight	Cable type: approx. 75g (plastic version), approx. 110g (metal version)	
	Connector type: approx. 25g (plastic version), approx. 60g (metal version)	
• [R] = Radial • [A] = Axial • [P] = Plastic • [M] = Metal • [PN] = PNP • [J] = M12 connector		

Typical Applications

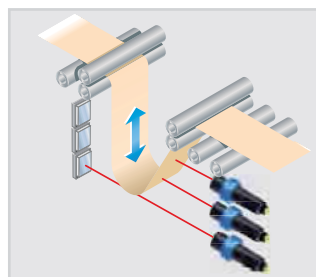

Control of sag

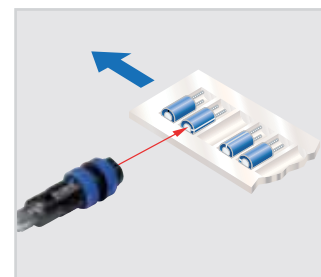

Detection of capacitors

Options

Cables

UZZ81220	UZZ81221	UZZ81250	UZZ81251
2m straight	2m elbow	5m straight	5m elbow

Mounting brackets

M18-ST20	M18-SPM

Reflector

M18-RF48

LC-100



Digital laser sensor



Features

■ Multifunction optoelectronic sensors

The **LC100 series** with a standard 50×50×15mm compact housing, offers all the most advanced optic functions including safety class 1 laser emission. This series offers versions with cable or M12 connection that can be rotated for either straight or right-angle positions. All versions have NPN or PNP output and standard configuration conforming to the EN 60947-5-2 standard. 16 types of LC100 are available.

■ Available in 4 versions

Laser through-beam

- Visible class 1 laser red light emission (typ. 650nm)
- Operating distance up to 60m with highest excess gain
- Resolution better than 6mm at 0.5m and 10mm over 2m
- Very high switching frequency up to 1.5kHz
- Double NO-NC output with NPN or PNP version
- Test input
- Plastic housing with compact dimensions 50×50×15mm

Laser polarized retroreflective

- Visible class 1 laser red light emission (typ. 650nm)
- Operating distance up to 20m
- Resolution better than 10mm
- Trimmer setting for fine sensitivity adjustment
- Very high switching frequency up to 2kHz
- Double NO-NC output with NPN or PNP version
- Plastic housing with compact dimensions 50×50×15mm

Diffuse reflective

- Visible class 1 laser red light emission (typ. 650nm)
- Operating distance 0 to 60cm
- Resolution approx. 0.2mm at 15cm
- Trimmer setting for fine sensitivity adjustment
- Very high switching frequency up to 2kHz
- Double NO-NC output with NPN or PNP version
- Plastic housing with compact dimensions 50×50×15mm

Background suppression

- Visible class 1 laser red light emission (typ. 650nm)
- Operating distance 5 to 10cm
- Resolution approx. 0.5mm at 6cm
- Teach-in setting
- Double NO-NC output with NPN or PNP version
- External teach-in
- Plastic housing with compact dimensions 50×50×15mm

Typical Applications

Positioning of printed circuit boards

Electronic industry

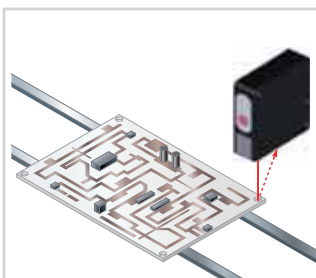

Detection of refrigerators

Packaging industry

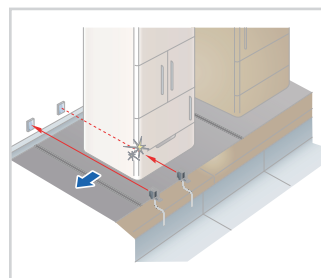

Detection of automobiles on conveyers

Automotive industry

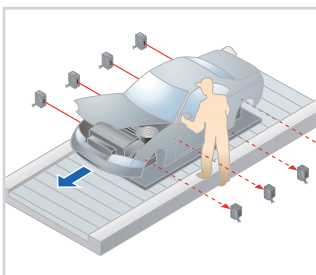

Technical Specifications



NPN-Output	LC-100-TL6000-A-P-[J]	LC-100-PL2000-A-P-[J]	LC-100-DL0060-A-P-[J]	LC-100-BL0010-A-P-[J]
PNP-Output	LC-100-TL6000-A-P-PN-[J]	LC-100-PL2000-A-P-PN-[J]	LC-100-DL0060-A-P-PN-[J]	LC-100-BL0010-A-P-PN-[J]
Sensor type	Thru-beam	Retroreflective	Diffuse reflective	Diffuse reflective with BGS
Maximum operation distance	60m	20m	600mm	100mm
Sensing range	0 to 60m	0.1 to 20m	0 to 600mm	50 to 100mm
Sensing object	Metal, black		Paper, white	
	Ø 6mm		200 x 200mm	100 x 100mm
Detectable target	Opaque	Opaque, translucent	Opaque, transparent	
Hysteresis	-	-	±1%	
Response time	Approx. 333µs	Approx. 250µs		500µs
Output	Max. 100mA			
Emitting element	Red semiconductor laser, 650nm (Class 1)			
Current consumption without load	Emitter: max. 35mA Receiver: max. 35mA	Max. 35mA		Max. 60mA
Material	Enclosure: Plastic			
Protection	IP67			
Dimensions (H×W×D)	Cable type: approx. 50×50×15mm			
	Connector type: approx. 50×66×15mm			
Connection	Cable 2m or M12 connector			
Supply voltage	10 to 30VDC			
Ambient temperature	Operation: -10 to +50°C, storage: -25 to +70°C			
Weight	Cable type: approx. 90g Connector type: approx. 40g			

[PN] = PNP • [J] = M12 connector

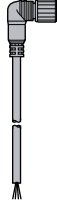

*Reflector not included

Options

■ Cables

UZZ81220	UZZ81221	UZZ81250	UZZ81251
2m straight	2m elbow	5m straight	5m elbow
			

■ Mounting brackets

LC1-ST60	LC1-ST26	LC10-ST62
		

■ Reflector

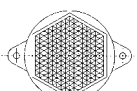
M18-RF48

LC-120

LC-120



High-performance sensors



Features

■ Maximum performance in compact housing

The **LC120 series** comes in a 50×50×18mm compact plastic housing and offers the maximum performance of optic detection functions for industrial automation.

Furthermore, versions with visible red laser emission are available with 50–350mm background suppression and polarized retroreflex reaching more than 20m.

These laser sensors are characterized by a very small light spot as well as a low response time that guarantee excellent detection repeatability, even of very small objects or movements.

- High-resolution sensors with LED or laser emission
- Background suppression models ranging up to 350mm
- Polarized retroreflex with operating distance of up to 20m
- Plastic housing with compact dimensions of 50×50×18mm
- NPN or PNP double output with standard NO-NC
- Visible class 2 laser red light emission (typ. 658nm)
- Very fast response time less than 200µs
- Very high switching frequency of up to 2.5kHz

Typical Applications

Foil detection

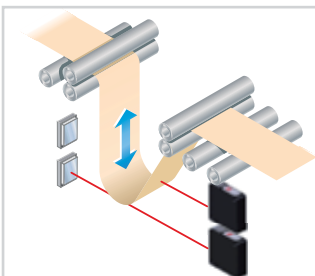

Pharmaceutical industry

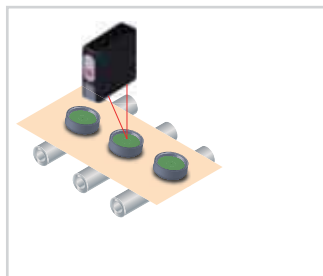



Technical Specifications

NPN-Output	LC-120-PL2000-A-P-J	LC-120-BL0015-A-P-J	LC-120-BL0035-A-P-J
PNP-Output	LC-120-PL2000-A-P-PN-J	LC-120-BL0015-A-P-PN-J	LC-120-BL0035-A-P-PN-J
Sensor type	Retroreflective	Reflective with BGS	
Maximum operation distance	20m	150mm	350mm
Sensing range	0.3 to 20m	30 to 150mm	50 to 350mm
Spot diameter	Ø 0.5mm (at 0.5m)	0.2mm (at 60mm)	0,4mm (at 150mm)
Sensing object	Metal, black Opaque, translucent	Paper, white Opaque	
	Ø 6mm	100 x 100mm	
Detectable target	Opaque		
Hysteresis	—	<1%	
Response time	200µs	140µs	200µs
Output	Max. 100mA		
Emitting element	Red semiconductor laser, 645 to 665nm (Class 2)		
Current consumption without load	Max. 30mA		
Material	Enclosure: Plastic		
Protection	IP67		
Dimensions (H×W×D)	Connector type: approx. 50×66×18mm		
Connection	M12 connector		
Supply voltage	10 to 30V DC		
Ambient temperature	Operation: -10 to +50°C, storage: -25 to +70°C		
Weight	Approx. 40g		
[PN] = PNP • [J] = M12 connector			

*Reflector not included

Options

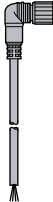
■ Cables

UZZ81220	UZZ81221	UZZ81250	UZZ81251
2m straight	2m elbow	5m straight	5m elbow
			

■ Mounting brackets

LC12-ST50	LC1-ST60	LC1-ST26
		

■ Reflector

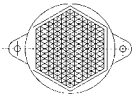
M18-RF48

EX-L200



EX-L200



World's smallest laser sensor with built-in amplifier

Features

■ Minute object sensing type EX-L211 (through beam)

The beam is purposely widened to have a lower beam density and little beam spread so that when detecting minute objects, even a slight change in the light received intensity will not be missed.

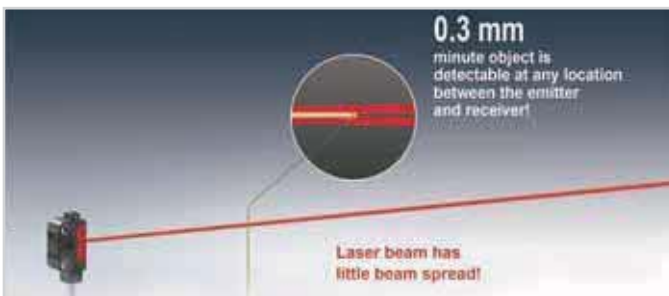

■ Minute detection (reflective)

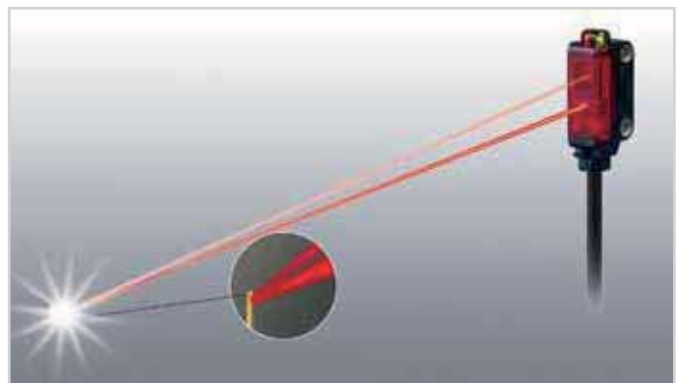

■ Environmental resistance

Strong against water and dust with protection structure IP67

The sensor can be used even in environments where water or dust is present.

■ Easy alignment

Beam alignment is easy

Beam alignment is carried out by looking at the red spot reflected on the beam alignment screen to match with the actual object. The optimum position can be understood at a glance by looking at the beam alignment screen and stability indicator (green).

Even the shadow of the sensing object is reflected to make alignment effortless!

Typical Applications

Detecting ICs that are out of position in multiple palettes



Detecting tip of very thin pipe



Detecting objects from an opening

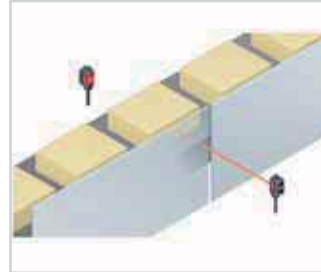

Technical Specifications



NPN output PNP output	EX-L211 EX-L211-P	EX-L212 EX-L212-P	EX-L221 EX-L221-P
Sensor type	Thru-beam Minute object sensing		Spot reflective Minute object sensing
Maximum operation distance	1m	3m	300mm
Sensing range	0 to 1m	0 to 3m	45 to 300mm
Spot diameter (approx.)	6x4mm at 1m	8x5.5mm at 1m	dia. 1mm at 300mm
Sensing object	Opaque Ø 2mm or more		Opaque translucent or transparent gold wire with dia. 0,01mm
Response time	0.5ms or less		
Output	Max. 100mA		
Emitting element	Red laser diode, 655nm (class 1)		
Current consumption without load	Ermittler: max. 10mA Receiver: max. 10mA		max 15mA
Material	Body: PBT Front cover: Acrylic Lens: Glas		
Protection	IP67		
Dimension (HxWxD)	25.9x8.2x12mm		29.9x8.2x13mm
Connection	Cable 2m		
Supply voltage ambient temperature	10 to 30VDC Operation: -10 to +55°C, Storage: -30 to +70°C		
Weight	Approx. 90g		Approx. 60g

ST

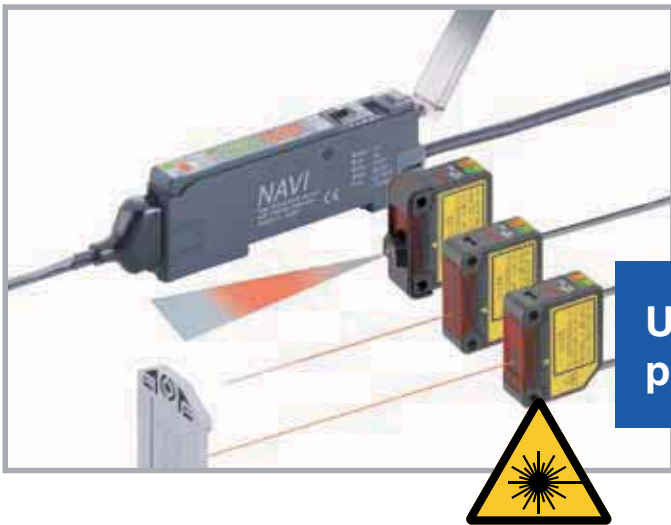

LS

User-friendly, advanced high precision laser sensing!

Features

■ 4 types of identically sized sensor heads available

They are approximately the same size as general purpose photoelectric sensors, and the mounting method is identical.

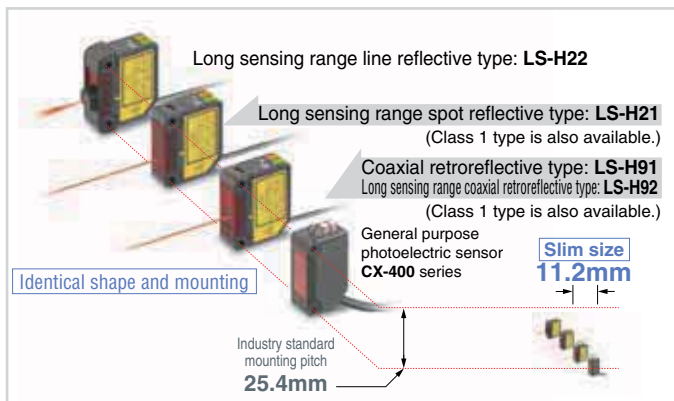

■ Coaxial reflective type with a long sensing range of 30m

The introduction of the **LS-H92** long sensing range coaxial reflective type sensor means that even longer sensing ranges are now possible.

■ Spot size adjustment

The long sensing range spot reflective type and long sensing range line reflective type have a built-in spot-size adjuster that enables spot size adjustment according to the object for optimal setting.

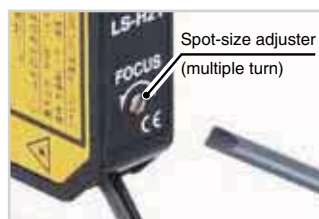

■ Accurately senses the minutest variations

When sensing at close range or when the target objects are transparent or minute, adjust the sensor receiving sensitivity to one of 3 levels for the optimal setting. In addition, changing the receiving sensitivity will not affect the response time.

■ Easy setting, dual display

Equipped with 2 large 4-digit digital displays. While checking the current light-receiving amount (red display), the optimal threshold value (green display) can be set easily.

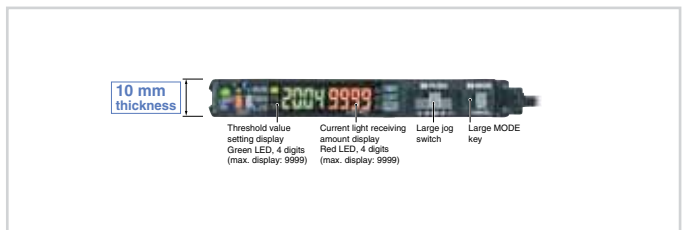

■ Wiring and space savings

The quick-connection cables enable reductions in wiring (connector type). The connections and man hours for the intermediate terminal block setup can be reduced and valuable space saved. Also, LS series amplifiers can be connected side-by-side with FX-300 series fiber sensors.

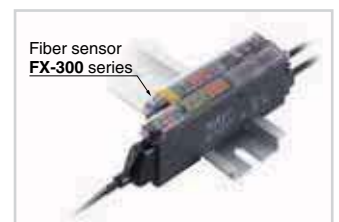

Interference prevention function

The automatic interference prevention function protects against interference among up to 4 sensors.

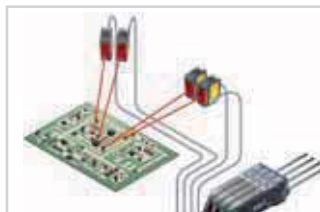

Emission halt function

Using the emission halt function, the laser beam can be stopped via external input, e.g. when a spot appears within the visual range of an image processor.



External teaching function

Teaching can be conveniently performed externally for laser sensors installed inside a device.



Typical Applications

IC pin check from remote position



Checking protrusion of glass substrate



Technical Specifications

Sensor heads

Type	Coaxial retroreflective		Diffuse reflective	
		Long sensing range type	Long sensing range spot reflective	Long sensing range line reflective
Model no. (Note 1)	LS-H91(F) (-A)(Note 2)	LS-H92(F)	LS-H21(F) (-A)(Note 2)	LS-H22(F) (Note 3)
Sensing range	0.1 to 7m (U-LG) 0.1 to 5m (STD) 0.1 to 3m (FAST/H-SP)	0.2 to 30m (U-LG) 0.2 to 20m (STD) 0.2 to 10m (FAST/H-SP)	30 to 1000mm (U-LG) 30 to 500mm (STD) 30 to 300mm (FAST/H-SP)	30 to 1000mm (U-LG) 30 to 500mm (STD) 30 to 300mm (FAST/H-SP)
Ambient temperature	-10 to +55°C			
Emitting element	Red semiconductor laser, Class 2 (LS-HM: IEC/JIS/GB, LS-HMF: FDA/IEC/JIS) [LS-H91(F)-A, LS-H21(F)-A: Class 1] [Max. output: 3mW or less (LS-H91(F)-A, LS-H21(F)-A: 1 mW or less), Peak emission wavelength: 655nm]			
Dimensions (W×H×D)	11.2×31×25mm			

- Notes: 1) LS-H□ conforms to IEC/JIS/GB standards.
LS-H□F conforms to FDA/IEC/JIS standards.
2) LS-H91(F)-A, LS-H21(F)-A: Class 1 type.
3) LS-H22(F) = LS-H21(F) long sensing range spot reflective type sensor head combined with the LS-MR1 lens attachment for line reflective. LS-H22(F) is only the order number.
LS-H21(F) appears on the sensor itself.

Amplifiers

Type		Connector (Note)	Cable
Model no.	NPN output	LS-401	LS-401-C2
	PNP output	LS-401P	LS-401P-C2
Supply voltage		12 to 24VDC ±10%	
Output (Output 1, Output 2)		NPN output type: NPN open-collector transistor PNP output type: PNP open-collector transistor	
Output operation		Selectable either Light-ON or Dark-ON, with jog switch	
Response time		80µs or less (H-SP), 150µs or less (FAST), 500µs or less (STD), 4ms or less (U-LG), selectable with jog switch	
Sensitivity setting		Normal mode: 2-level teaching/limit teaching/full auto teaching/manual adjustment Window comparator mode: teaching (1-level, 2-level, 3-level)/manual adjustment Hysteresis mode: teaching (1-level, 2-level, 3-level)/manual adjustment Differential mode: 5-level settings	
Digital display		4 digit (green) + 4 digit (red) LED display	
Automatic interference prevention function		Incorporated [up to four sets of sensor heads can be mounted close together (however, disabled when in H-SP mode)]	
Ambient temperature		-10 to +55°C (if 4 to 7 units are mounted close together: -10 to +50°C if 8 to 16 units are mounted close together: -10 to +45°C)	
Dimensions (W×H×D)		10×30×75mm	

- Notes: The cable for amplifier connection is not supplied as an accessory with the connector type amplifier. Make sure to use the optional quick-connection cable listed below.
Main cable (4-core): CN-74-C1 (cable length 1m), CN-74-C2 (cable length 2m)
CN-74-C5 (cable length 5m)
Sub cable (2-core): CN-72-C1 (cable length 1m), CN-72-C2 (cable length 2m)
CN-72-C5 (cable length 5m)
Sensing range:
LS-H91(F)-A 0.1 to 5m (U-LG), 0.1 to 3m (STD), 0.1 to 1m (FAST/H-SP)
LS-H21(F)-A 30 to 500mm (U-LG), 30 to 250mm (STD), 30 to 150mm (FAST/H-SP)



LX-100

Introducing the 3-LED mark sensor

Features

■ Equipped with 3 LEDs: red, green and blue

To detect any marking, this sensor is equipped with red, green and blue LED light emitting elements all in one. In addition, it uses a coaxial reflective optics system and realizes high precision sensing when used with a 1/4000 resolution 12-bit A/D converter.

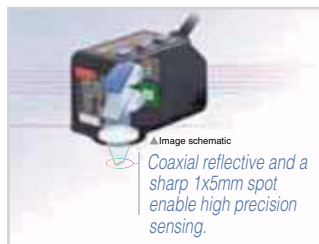

■ 2 selectable sensing modes for any application

Mark mode: This sensing mode automatically selects a single color from the 3 R-G-B LEDs to realize an ultra quick 45µs response time. The automatic optimal LED selection function automatically selects the LED that is most suitable for the sensing. This function is perfect for ultra quick sensing.

Color mode: All 3 R-G-B LEDs light up and high precision mark color discrimination occurs using the R-G-B reflective light ratio. This function enables effective detection of films with patterns around the areas of the mark.

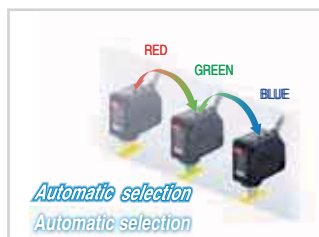

■ Even beginners can quickly master MODE NAVI operation

The sensor's basic operations are represented by 6 indicator lamps (MODE NAVI). The user can check what mode the sensor is presently in with a quick glance rendering operation simple.

Sensing status digitally controllable

The sensing status, displayed numerically, can be verified at a glance. Also, the sensor settings for each type of packing film can be digitally indicated.

Direct codes enable settings verification at a glance

The settings for the LX-100 series sensors are displayed using a 4-digit direct code. Direct codes enable easy settings verification and maintenance by phone.

Super simple teaching

Teaching (setting the threshold value) is simple, even in 'Mark Mode' or 'Color Mode'. In addition, because teaching via an operation panel or other external input device is also possible, models can be easily interchanged.

Compact design for significant space savings

High precision sensing and multiple functions are provided in a compact 57×24×35mm (W×D×H) body. Cable and plug-in connector types are available depending on the equipment used. These sensors can be easily integrated into already existing systems.



Typical Applications

Tube positioning

Detects printed marks to align tubes



Mark detection

Mark detection of packaging film

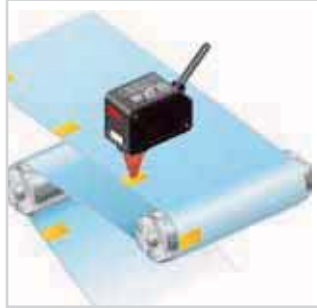

Technical Specifications

Type		Cable	Plug-in connector
Model. no.	NPN output	LX-101	LX-101-Z (Note)
	PNP output	LX-101-P	LX-101-P-Z (Note)
Sensing range		10 ±3mm	
Supply voltage		12 to 24VDC ±10%	
Output		NPN output type: NPN open-collector transistor PNP output type: PNP open-collector transistor	
Output operation		Mark mode: Light-ON/Dark-ON (auto-setting on teaching) Color mode: Consistent-ON/Inconsistent-ON (Setting on teaching)	
Response time		Mark mode: 45µs or less; color mode: 150µs or less	
Sensitivity setting		Mark mode: 2-level teaching/full-auto teaching; Color mode: 1-level teaching	
Protection		IP67 (IEC)	
Ambient temperature		-10 to +55°C	
Emitting element		Combined Red/Green/Blue LEDs (Peak emission wave length: 640nm/525nm/470nm)	
Dimensions (W×H×D)		71.5×24×35mm	

Note: Mounting cable is not supplied with the plug-in connector type. Please order separately.

Options

■ Cables

UZZ81220	UZZ81221	UZZ81250	UZZ81251
2m straight	2m elbow	5m straight	5m elbow

CX-400



A full lineup of world standard photoelectric sensors

Features

■ Great lineup of 116 models

The **CX-400** series has a high level of basic functionality and excellent cost performance. Moreover, a wide number of variations means that there is sure to be a sensor that fits your needs.

Type	Sensing range
CX-412 □ Thru-beam (long sensing range)	15m
CX-411 □ Thru-beam	10m
CX-493 □ Retroreflective (long sensing range)	5m
CX-491 □ Retroreflective (with polarizing filters)	3m
CX-482 □ Retroreflective (transparent object sensing)	0.1 to 2m
CX-481 □ Retroreflective (transparent object sensing)	50 to 500mm
CX-422 □ Diffuse reflective (800mm type)	800mm
CX-421 □ Diffuse reflective (300mm type)	300mm
CX-424 □ Diffuse reflective (100mm type)	100mm
CX-423 □ Diffuse reflective (narrow-view)	70 to 200mm
CX-442 □ Adjustable range reflective	20 to 300mm
CX-444 □ Adjustable range reflective	15 to 100mm
CX-443 □ Adjustable range reflective	2 to 50mm
CX-441 □ Adjustable range reflective (small spot)	2 to 50mm
Output	NPN, PNP
Connecting method (Note 1)	Cable type, M8 plug-in connector type, M12 pigtailed type
Cable length of cable type (Note 2)	0.5m, 2m, 5m

Notes: 1) Only the cable type and M8 plug-in connector type are available for the adjustable range reflective type.
2) Only the 2m cable length type (standard) is available for the adjustable range reflective type.

■ Compact size

The sensors are compact in size at 11.2×31×20mm (W×H×D). The mounting pitch is also at the world standard size of 25.4mm (1inch).

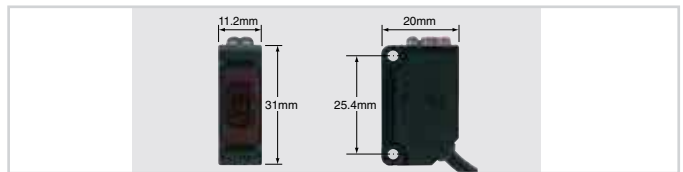

■ Less processing

M8 plug-in connector type and M12 pigtailed type are available. This contributes to less time spent setting up. In addition, cable types are available with cable lengths of 0.5m, 2m and 5m. This results in less waste.

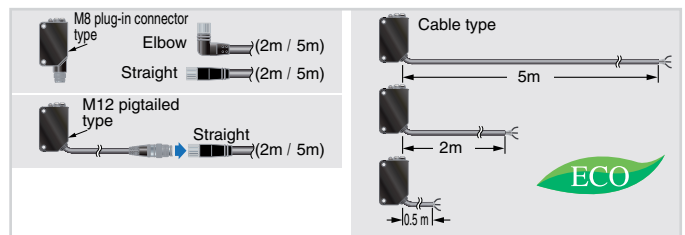

■ Less power consumed

The **CX-400** series sensors achieve a maximum of approx. 55% of the power consumption of conventional sensors. This contributes to preserving the environment.

■ Less resources used

Based on environmental considerations, simplified packaging is used in order to reduce waste.

In addition, the bag is made of polyethylene, which produces no toxic gases even when burned.

■ Strong against oil and coolant CX-41□/42□/49□

The lens material for the thru-beam type, retroreflective type (excluding the CX-48□) and the diffuse reflective type is made of a strong acrylic that resists the harmful effects of coolants. These sensors can be used with confidence even around metal processing machinery that disperses oil mists. The protection mechanism also conforms to IP67 (IEC).

■ Strong against ethanol CX-44□/48□

A strong, ethanol-resistant polycarbonate is used for the front and display covers. Safe even for installing near food processing machinery that disperses ethanol-based detergents. The protection mechanism also conforms to IP67 (IEC).

■ Strong against interference

The interference prevention function allows two sensors to be mounted close together.

Typical Applications

Detecting car on conveyor line



Thru-beam type CX-412□

Strong infrared beam

It realizes a 15m long-distance sensing range. Remarkable penetrating power enables applications such as package content detection.

Detecting transparent bottles



Retroreflective type CX-493□

Strongest sensing range in its class

A long 5m sensing range is possible with the red LED type that is easy to align with the beam axis. Can be used for wide automatic door shutters.

Detecting label

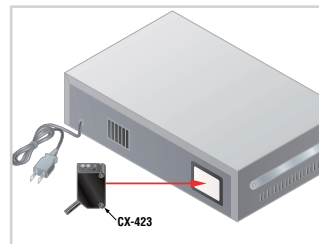

Diffuse reflective type CX-423□

Beam axis alignment made easy

These sensors realize a high luminance red LED spot that provides bright visibility enabling the sensing position to be checked at a glance. Because it has the small spot, approx. Ø2mm, even the minutest object can be accurately detected.

CX-481□/482□

Introducing the transparent object sensing type sensor

Our unique optical system and transparent object sensing circuitry provide stable sensing of even thinner transparent objects than the conventional models.



CX-441/443□

Can sense differences as small as 0.4mm, with hysteresis of 2% or less

An advanced optical system provides sensing performance that is approx. 2.5 times more precise than conventional models. Even ultra small differences of 0.4mm can be detected accurately.



CX-44□

Not affected by color

Both black and white objects can be sensed at almost the same distances. No adjuster control is needed, even when products of different colors are moving along the production line.



BGS/FGS functions make even the most challenging settings possible!

Background not present



When object and background are separated.

Background present



When object and background are close together.

When the object is glossy or uneven.

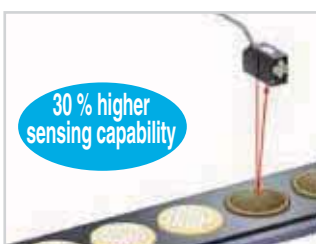

CX-400 Technical Specifications

Type		Thru-beam		Retroreflective				Diffuse reflective			
		Long sensing range		With polarizing filters	Long sensing range		For transparent object sensing				
Model. no.	NPN	CX-411	CX-412	CX-491	CX-493	CX-481	CX-482	CX-424	CX-421	CX-422	CX-423
	PNP	CX-411-P	CX-412-P	CX-491-P	CX-493-P	CX-481-P	CX-482-P	CX-424-P	CX-421-P	CX-422-P	CX-423-P
Sensing range		10m	15m	3m	5m	50 to 500mm	0.1 to 2m	100mm	300mm	800mm	70 to 200mm
Supply voltage		12 to 24VDC±10%									
Output		NPN output type: NPN open-collector transistor, PNP output type: PNP open-collector transistor									
Output operation		Switchable either Light-ON or Dark-ON									
Response time		1ms or less									
Automatic interference prevention function		Two units of sensors can be mounted close together with interference prevention filters. (Sensing range: 5m)	–	Incorporated (two units of sensors can be mounted close together.)							
Protection		IP67 (IEC)									
Ambient temperature		–25 to +55°C									
Emitting element (modulated)		Red LED	Infrared LED	Red LED			Infrared LED			Red LED	



Note: 0.5m/5m cable length type (standard: 2m), M8 plug-in connector type, and M12 pigtailed type are available.

Type		Adjustable range reflective			
		Small spot			
Model. no.	NPN output	CX-441	CX-443	CX-444	CX-442
	PNP output	CX-441-P	CX-443-P	CX-444-P	CX-442-P
Adjustable range (Note 1)		20 to 50mm		20 to 100mm	40 to 300mm
Sensing range (with white non-glossy paper)		2 to 50mm		15 to 100mm	20 to 300mm
Supply voltage		12 to 24VDC ±10%			
Output		NPN output type: NPN open-collector transistor, PNP output type: PNP open-collector transistor			
Output operation		Switchable either Detection-ON or Detection-OFF			
Response time		1ms or less			
Sensing mode		BGS/FGS functions Switchable with wiring of sensing mode selection input			
Protection		IP67 (IEC)			
Ambient temperature		–25 to +55°C			
Emitting element		Red LED (modulated)			

Notes: 1) The adjustable range stands for the maximum sensing range which can be set with the distance adjuster. The sensor can detect an object at a distance of 2mm [CX-444(-P): 15mm, CX-442(-P): 20mm] or more.
2) M8 plug-in connector type is also available.

Options

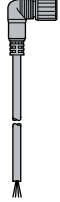
Cables for M8

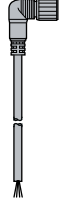
UZZ80820	UZZ80821	UZZ80850	UZZ80851
2m straight	2m elbow	5m straight	5m elbow
			

Cables for M12

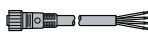
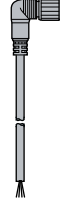
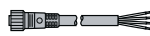
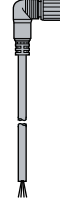
UZZ81220	UZZ81221	UZZ81250	UZZ81251
2m straight	2m elbow	5m straight	5m elbow
			



NX5

Sensor world-wide usable

Features

■ Multi-voltage

24 to 240VAC and 12 to 240VDC, suitable for supply voltages all over the world.

■ High reliability

The **NX5** has IP66 protection. Moderate dust or water splashes do not affect it.

The hermetically sealed output relay significantly increases its reliability.

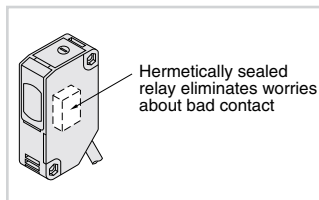

■ Interference prevention

Two sensors operate normally even when mounted close together (excluding the 30m thru-beam type sensor).

■ Long sensing range

Suitable for conveyor lines and parking lot applications.

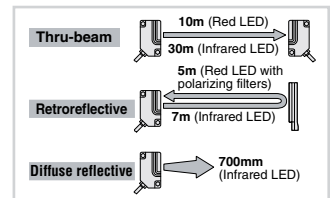

Typical Applications

Multistoried parking

Detects if the car is protruding from the elevator door.



Golf driving range

The sensor detects the presence of a golf ball. The sensor is multi-voltage type so no DC power supply is needed.

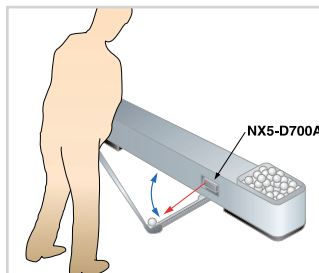

Arresting shutter closing

The long sensing range sensor with a visible red beam can be used to control the shutter operation at the gate of a factory.

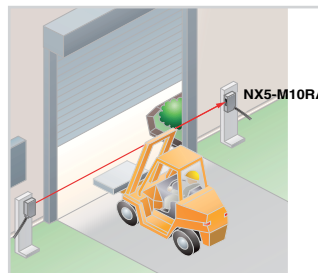

Arresting door closing

The sensor detects a person or an object and prevents the door from closing as long as its beam is interrupted.

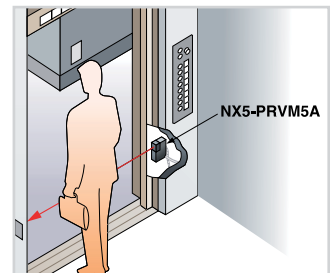

Technical Specifications

	Type	Thru-beam				Retroreflective				Diffuse reflective	
				Long sensing range		With polarizing filters		Long sensing range			
Item	Model no.	NX5-M10RA	NX5-M10RB	NX5-M30A	NX5-M30B	NX5-PRVM5A	NX5-PRVM5B	NX5-RM7A	NX5-RM7B	NX5-D700A	NX5-D700B
Sensing range		10m		30m		0.1 to 5 m (Note 1)		0.1 to 7m (Note 1)		700mm (Note 2)	
Sensing object		∅20mm or more opaque object (Note 3)				∅50mm or more opaque, translucent or specular object (Note 1)		∅50mm or more opaque or translucent object (Note 1)		Opaque, translucent or transparent object	
Hysteresis		—									
Repeatability (perpendicular to sensing axis)		0.1mm or less			0.2mm or less					0.3mm or less	
Supply voltage		24 to 240VAC ±10%, or 12 to 240VDC ±10% Ripple P-P 10% or less									
Power consumption		Emitter: 1 VA or less Receiver: 2 VA or less		Emitter: 1.5VA or less Receiver: 2 VA or less		2VA or less					
Output		Relay contact 1c • Switching capacity: 250VAC 1A (resistive load) 30V DC 2A (resistive load) • Electrical life: 500,000 or more switching operations (switching frequency 3600 operations/hour) • Mechanical life: 100 million or more switching operations (switching frequency 36,000 operations/hour)									
Output operation		Light-ON	Dark-ON	Light-ON	Dark-ON	Light-ON	Dark-ON	Light-ON	Dark-ON	Light-ON	Dark-ON
Response time		10ms or less									
Operation indicator		Red LED (lights up when the output is ON)									
Stability indicator		Green LED (lights up under stable light received condition or stable dark condition)									
Power indicator		—		Red LED (lights up when the power is ON)		—					
Sensitivity adjuster		Continuously variable adjuster		—		Continuously variable adjuster		—		Continuously variable adjuster	
Automatic interference prevention function		Use optional interference prevention filters		—		Incorporated (two sensor units can be mounted close together.)					
Environmental resistance	Pollution degree	3 (industrial environment)									
	Protection	IP66 (IEC)									
	Ambient temperature	-20 to +55°C (no dew condensation or icing allowed)(Note 4); storage: -30 to +70°C									
	Ambient humidity	35 to 85% RH; storage: 35 to 85% RH									
	Ambient illuminance	Sunlight: 11,000 lx at the light-receiving face; incandescent light: 3500 lx at the light-receiving face									
	EMC	EN 50081-2, EN 50082-2, EN 61000-6-2									
	Voltage with standability	1500VAC for one min. between power supply and output terminals; 1000VAC for one min. between relay contact terminals									
	Insulation resistance	20MΩ, or more, with 500VDC megger between power supply and output terminals, and between relay contact terminals									
	Vibration resistance	10 to 55Hz frequency, 1.5mm amplitude in X, Y and Z directions for two hours each									
	Shock resistance	500m/s ² (50G approx.) in X, Y and Z directions for three times each									
Emitting element (modulated)		Red LED (modulated)		Infrared LED (modulated)		Red LED (modulated)		Infrared LED (modulated)			
Material		Enclosure: Polycarbonate; lens: polycarbonate; cover: polycarbonate; front cover (retroreflective type sensor only): acrylic									
Cable		0.3mm ² 5-core (thru-beam type emitter: 2-core) cabtyre cable, 2m long									
Cable extension		Extension up to total 100m is possible with 0.3mm ² , or more, cable (thru-beam type: both emitter and receiver)									
Weight		Emitter: 100g approx. Receiver: 140g approx.		Emitter: 125g approx. Receiver: 140g approx.		140g approx.					
Accessory		Adjusting screwdriver: 1 pc		—		RF-230 (reflector): 1 pc. Adjusting screwdriver: 1 pc.		RF-230 (reflector): 1 pc.		Adjusting screwdriver: 1 pc.	

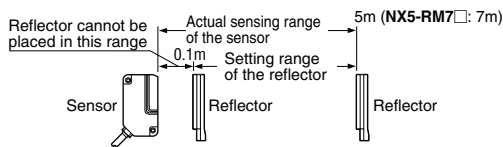

- Notes:**
- 1) The sensing range and the sensing object of the retroreflective type sensor is specified for the **RF-230** reflector. Further, the sensing range is the possible setting range for the reflector. The sensor can detect an object less than 0.1m away.
 - 2) The sensing range of the diffuse reflective type sensor is specified for white non-glossy paper (200×200m) as the object.
 - 3) If slit masks (optional) are fitted, an object as small as 3×6mm can be detected.
 - 4) In the event that the sensor is to be used at an ambient temperature of -15°C, or less, please contact our office.

CY

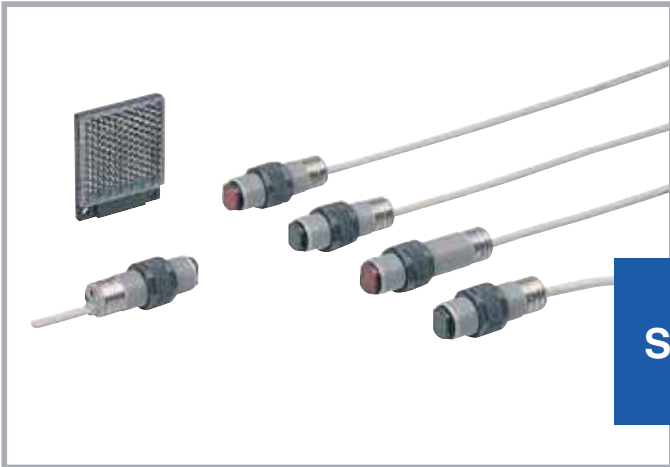

CY

Simple mounting with M18 thread

Features

■ M18 thread

This sensor has an M18 thread on the enclosure, which is convenient for mounting.

■ Easy to replace

A pigtailed type sensor with M12 connector (CY-□-J) is easy to replace.

■ Environmentally robust

Both the sensor and connector have an IP67 degree of protection. In addition, it is resistant to vibration since it is filled with resin.

■ Wide product range

Supply voltage

- ① AC supply type (24 to 240VAC)
- ② DC supply type (10 to 30VDC)

Output

- ① NPN open-collector transistor
- ② PNP open-collector transistor
- ③ AC non-contact (thyristor) output

Connection

- ① Cable type
- ② Pigtailed type

A total of 32 models are available.



Typical Applications

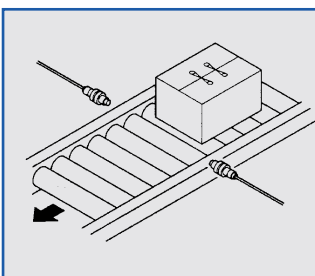

Object detection

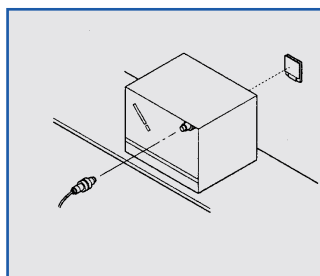

Position detection

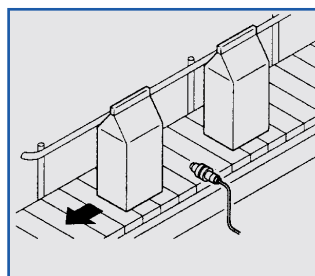

Object detection

Technical Specifications

■ AC supply type

Light ON	CY-11A (-J)	CY-17A (-J)	CY-19A (-J)	CY-12A (-J)
Dark ON	CY-11B (-J)	CY-17B (-J)	CY-19B (-J)	CY-12B (-J)
Sensor type	Thru-beam	Retroreflective	Retroreflective with polarization filter	Diffuse
Rated sensing distance	12m	3m	1.5m	0.12m
Standard detectable object	Metal, matt black			White drawing paper
	∅ >= 8mm	∅ >= 50mm		5 x 5cm
Detectable target	Opaque	Opaque, semitransparent		Opaque, transparent
Hysteresis	--	--	--	< 15% of measurement range
Response time	Max. 20ms			
Output thyristor	Min. 5mA, max. 200mA			
Emitting diode	Infrared LED		Red LED	Infrared LED
Rated current consumption without load	Transmitter: max. 1.5VA Receiver: max. 2.5V	Max. 2.7VA		
Housing material	Plastic			
Protection	IP67			
Physical size (∅xL)	M18 x 71mm			
Connection method	Cable 2m or M12 connector (-J)			
Operating voltage	24 - 240VAC (±10%)			
Usable ambient temp.	-25°C to +55°C			
Weight (approx.)	190g	100g		

Technical Specifications

■ DC supply type

NPN output	CY-21 (-J)	CY-27 (-J)	CY-29 (-J)	CY-22 (-J)
PNP output	CY-21-PN (-J)	CY-27-PN (-J)	CY-29-PN (-J)	CY-22-PN (-J)
Sensor type	Thru-beam	Retroreflective	Retroreflective with polarization filter	Diffuse
Rated sensing distance	12m	3m	1.5m	12cm
Standard detectable object	Metal, matt black			White drawing paper
	∅ >= 8mm	∅ >= 50mm		5 x 5cm
Detectable target	Opaque	Opaque, semitransparent		Opaque, transparent
Hysteresis	--	--	--	< 15% of measurement range
Response time	Max. 2ms			
Output transistor	Max. 100mA			
Emitting diode	Infrared LED		Red LED	Infrared LED
Rated current consumption without load	Transmitter: max. 20mA Receiver: max. 25mA	Max. 25mA		
Housing material	Plastic			
Protection	IP67			
Physical size (∅xL)	M18 x 56mm			
Connection method	Cable 2m or connector (-J)			
Operating voltage	10 - 30VDC (±10%)			
Usable ambient temp.	-25°C to +55°C			
Weight (approx.)	190g	100g		



M18

Photoelectric sensor basic line

Features

- Basic models available with axial or radial optics
- Versions with NPN or PNP output, cable or M12 connector
- Standard 3-wire connection configuration
- Selectable dark or light output
- Plastic or metal housing

Technical Specifications

Plastic PNP	M18-T120P-PN(-J)	M18-R020P-PN(-J)	M18-P015P-PN(-J)	M18-D003P-PN(-J)
Plastic NPN	M18-T120P(-J)	M18-R020P(-J)	M18-P015P(-J)	M18-D003P(-J)
Metal PNP	M18-T120M-PN(-J)	M18-R020M-PN(-J)	M18-P015M-PN(-J)	M18-D003M-PN(-J)
Metal NPN	M18-T120M(-J)	M18-R020M(-J)	M18-P015M(-J)	M18-D003M(-J)
Sensor type	Through-beam	Retroreflective	Retroreflective with polarizing filter	Reflective
Rated sensing distance	12m	2m	1.5m	30cm
Standard detectable object	Metal, black matt finish			
Detectable target	∅5mm or more, opaque object	∅35mm or more, opaque or transparent object	∅7.5mm or more, opaque or transparent object	∅5mm or more, opaque or transparent object
Hysteresis	-	-	-	≤ 15% of the measurement range
Response time	Max. 2ms		Max. 1ms	
Output transistor	Max. 100mA			
Emitting diode	Infrared LED		Red LED	Infrared LED
Current consumption without load	Emitter: max. 20mA Receiver: max. 25mA		Max. 30mA	
Housing material	Plastic/nickel-plated brass			
Protection	IP67			
Physical size (∅ x L)	M18x57mm			
Connection method	Cable 2m; plug connection (J)			
Operating voltage	10 to 30V DC (±10%)			
Usable ambient temperature	-25°C to +55°C			
Weight	Max. 210g		Max. 110g	

Typical Applications

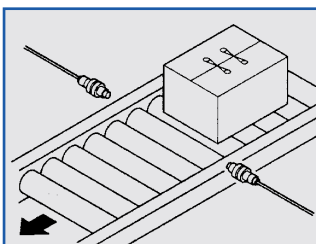

Object detection

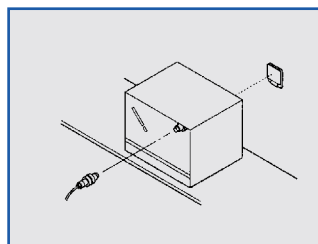

Position detection

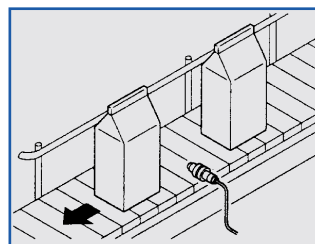

Object detection

EX-10



The smallest: 3.5mm thick

Features

■ Freely mountable fingertip size

Freely mountable 10×14.5×3.5mm (W×H×D) size (thru-beam, front sensing type). Moreover, easy alignment is possible with the visible red LED beam source.

■ Long sensing range 1m: EX-19□

■ 2-color indicator

A convenient bright, 2-color indicator has been incorporated in the miniature body.

■ High-speed response time: 0.5 ms

The sensor is suitable for detecting small and high-speed traveling objects.

■ Flexible setup

The EX-10 series is available as a front sensing or side sensing type, allowing for flexible mounting in the narrowest of spaces.



Typical Applications

Detecting the float for a flow meter



Seating confirmation of FOUF

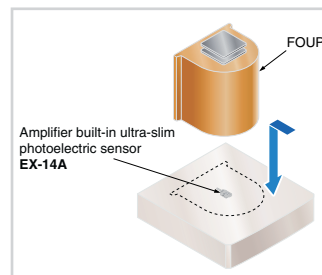

Detecting end of screw supply

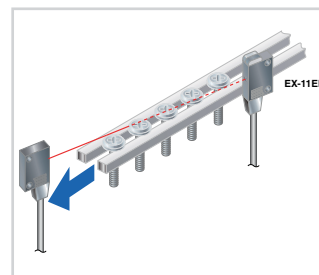

Sensing PCB rack

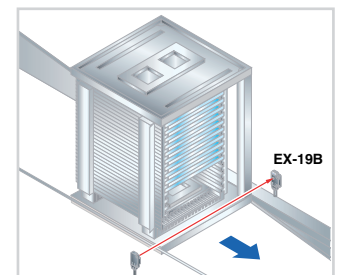

EX10 Technical Specifications

Type	Thru-beam						Convergent reflective	
Model. no.	EX-11A(-PN)	EX-11B(-PN)	EX-13A(-PN)	EX-13B(-PN)	EX-19A(-PN)	EX-19B(-PN)	EX-14A(-PN)	EX-14B(-PN)
Sensing range	150mm		500mm		1m		2 to 25mm (conv. point: 10mm)	
Min. sensing object	∅1mm opaque object		∅2mm opaque object				∅0.1mm copper wire (Setting distance: 10mm)	
Supply voltage	12 to 24VDC±10%							
Output	PNP / NPN open-collector transistor							
Output operation	Light-ON	Dark-ON	Light-ON	Dark-ON	Light-ON	Dark-ON	Light-ON	Dark-ON
Response time	0.5ms or less							
Protection	IP67 (IEC)							
Ambient temperature	-25 to +55°C							
Dimensions (W×H×D)	10×14.5×3.5mm						13×14.5×3.5mm	

Options

■ Slit mask available for EX-13□/19□

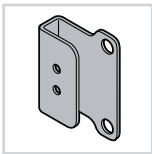

OS-EX10-12
OS-EX10-15

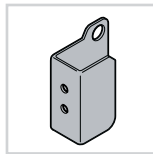

OS-EX10E-12

EX-20

EX20



Miniature-sized and still mountable with M3 screws

Features

■ Long sensing range

The EX-20 series achieves long distance sensing [thru-beam type: 2m, retroreflective type: 200mm (when using the attached reflector), diffuse reflective type: 160mm], despite its miniature size. Hence, it is usable even on a wide conveyor.

■ Clear beam spot using red LED dot light source

The emission area of a dot light source is smaller than that of a conventional LED flat light source, and it is possible to design a high power, narrow beam. Since a red LED dot light source is used, the red beam spot is clearly visible even at a long distance so that alignment and confirmation of sensing position is easy.

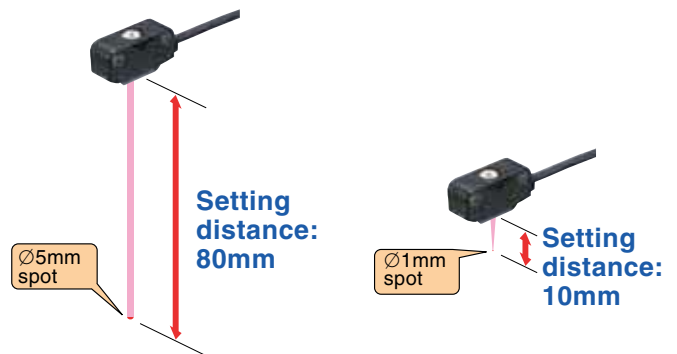

Typical Applications

Checking protrusion of wafer

The ultra compact photoelectric sensor EX-23 has a sufficiently long sensing range of 2m. Further, its visible red LED beam makes beam alignment very easy.

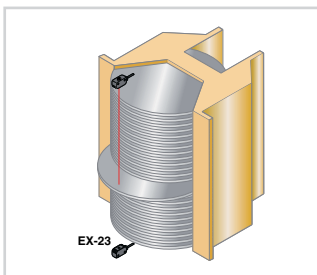

Detecting tape feeder cassette out of position

Ultra compact in size with an ample sensing range of 2m, ideal for monitoring tape feeder cassettes that are out of position.

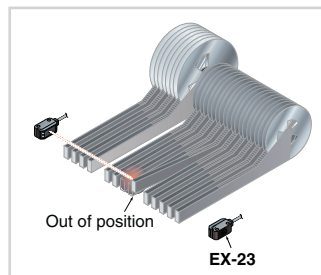

Detecting fill-up of parts in feeder

The sensor setting can be finely adjusted since a universal sensor mounting bracket, with which the height and the angle of the sensor can be freely adjusted, is available.

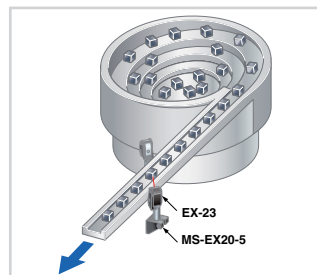

EX-20 Technical Specifications

Type		Thru-beam		Retroreflective	Diffuse reflective	Convergent reflective		Narrow-view reflective
		Front sensing	Side sensing	Side sensing	Side sensing	Diffuse beam	Small spot beam	Long distance spot beam
Model. no.	Light-ON	EX-21A(-PN)	EX-23(-PN)	EX-29A(-PN)	EX-22A(-PN)	EX-24A(-PN)	EX-26A(-PN)	EX-28A(-PN)
	Dark-ON	EX-21B(-PN)		EX-29B(-PN)	EX-22B(-PN)	EX-24B(-PN)	EX-26B(-PN)	EX-28B(-PN)
Sensing range		1m	2m	30 to 200mm	5 to 160mm	2 to 25mm (Conv. point: 10mm)	6 to 14mm (Conv. point: 10mm)	45 to 115mm
Sensing object		Min. \varnothing 2.6mm opaque object	Min. \varnothing 3mm opaque object	\varnothing 15mm or more opaque or translucent object	Opaque, translucent or transparent object	Min. \varnothing 0.1mm copper wire (Setting distance: 10mm)		Opaque, translucent or transparent object
Supply voltage		12 to 24VDC \pm 10%						
Output		NPN output type: NPN open-collector transistor; PNP output type: PNP open-collector transistor						
Response time		0.5ms or less						
Protection		IP67 (IEC)						
Ambient temperature		-25 to +55°C						
Dimensions (W×H×D)		16×18×4.5mm	8.2×22×10.5mm	8.2×25×12.3mm		16×18×4.5mm	8.2×25×12.3mm	10×14.5×3.5mm

EX-30

EX-30



A new alternative to fiber sensors

Features

- Can be installed in the same way as standard fibers

The EX-30 series can be screw-mounted (M4 for thru-beam type, M6 for reflective type) in the same way as standard fiber sensors. This means that they can be inserted into production lines in exactly the same way as conventional fiber sensors.

- 800mm thru-beam type available

The sensing range is 1.5 times greater than previous models! It also has a sensitivity adjuster to enable compatibility with a wide range of applications.

Typical Applications

Detecting quantity of labels in label magazine

Detects the remaining amount of labels by the thickness of the roll.

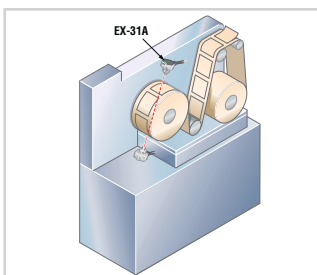

Detecting IC height

Detects whether ICs are accurately placed in IC trays.

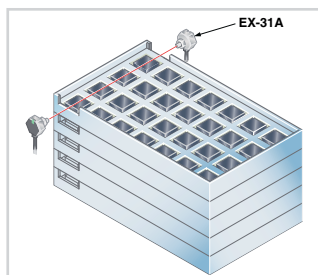

Resin bottle detection

The EX-32A threaded photoelectric sensor confirms the arrival of bottles.

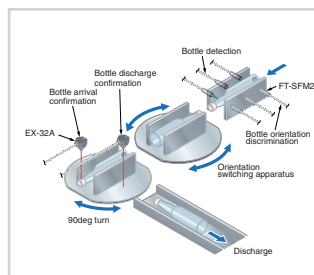

EX30 Technical Specifications

Type		Thru-beam			Diffuse reflective	
Model no.	NPN output	EX-31A	EX-31B	EX-33	EX-32A	EX-32B
	PNP output	EX-31A-PN	EX-31B-PN	EX-33-PN	EX-32A-PN	EX-32B-PN
Sensing range		500mm		800mm	50mm	
Sensing object		Min. Ø2mm or more opaque object			Opaque, translucent or transparent object	
Supply voltage		12 to 24VDC±10%				
Output		NPN output type: NPN open-collector transistor PNP output type: PNP open-collector transistor				
Output operation		Light-ON	Dark-ON	Variable (switching method)	Light-ON	Dark-ON
Response time		0.5ms or less				
Protection		IP67 (IEC)				
Ambient temperature		-25 to +55°C				

Note: 5m cable length type (standard: 2m) is also available [excluding EX-33(-PN)].

PM



Enables equipment miniaturization and quick construction

Features

■ Extremely compact

Ultra small type

PM-□24(-R) achieves an extremely compact size and can contribute to the miniaturization of your equipment.

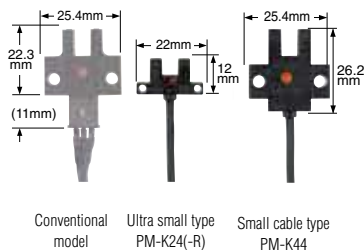

Conventional model Ultra small type PM-K24(-R) Small cable type PM-K44

■ Quick fitting hook-up connector

Easy to maintain hook-up connector type models are available.

Since only crimping with exclusive pliers needs to be done, cumbersome soldering or insulation is not required.

Further, a connector attached cable (CN-14H-C1/C3) is also available.

■ Equipped with two independent outputs

All models are equipped with two independent outputs—Light-ON and Dark-ON. Hence, one model suffices even if the output is to be used differently.

■ Flexible cable type

Flexible cable is used, which allows repeated bending. It is suitable for use in the moving part of a robot arm.

■ Quick-connector connections with commercially-available connectors

The connector is built-in, allowing greater space savings.

Commercially available general-purpose connectors can be used with some types for improved reliability.

PM Typical Applications

Sensing rotating bodies

By incorporating a slit in the rotating body, the origin point can be sensed.

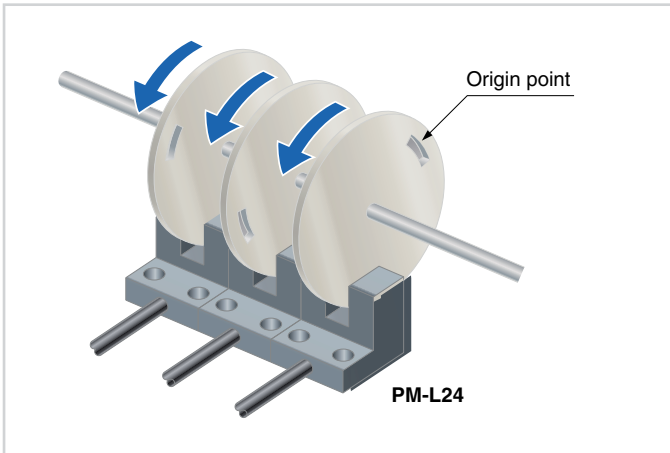

Determine the pallet position

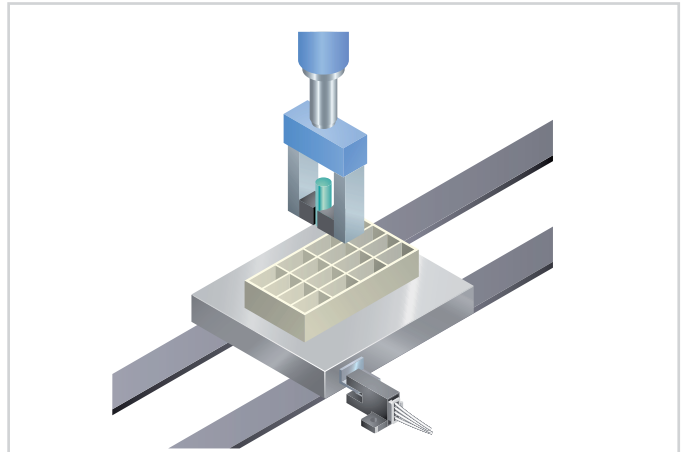

Technical Specifications

Type		Ultra small type	Small type		
		With cable	With cable	With connector	Built-in connector
Model no.	NPN output	PM-□24(-R) (Note)	PM-□44	PM-□54	PM-□64
	PNP output	PM-□24P	PM-□44P	PM-□54P	PM-□64P
Sensing range		5mm (fixed)			
Min. sensing object		0.821 × 1.8mm opaque object			
Repeatability		0.03mm or less	0.01mm or less		
Supply voltage		5 to 24V DC ±10%			
Output		NPN output type: NPN open-collector transistor PNP output type: PNP open-collector transistor			
Output operation		Incorporated with 2 outputs: Light-ON / Dark-ON			
Response time		Under light incident condition: 20μs or less Under light interrupted condition: 100μs or less (Response frequency: 1kHz or more)			
Emitting element		Infrared LED (non-modulated)			

Note: PM-□24-R is flexible cable type.
3m cable length type (standard: 1m) is also available (excluding flexible cable type and PNP output type).

Example: PM-K44
K = K-Type
L = L-Type
F = F-Type
R = R-Type
U = U-Type

Order Guide

Type	Appearance (mm in)	Sensing range	Model no. (Note)
Ultra-small	K type 	5 mm (fixed)	PM-K24
			PM-K24P
			PM-K24-R
	L type 		PM-L24
			PM-L24P
			PM-L24-R
	F type 		PM-F24
			PM-F24P
			PM-F24-R
	R type 		PM-R24
PM-R24P			
PM-R24-R			
U type 	PM-U24		
	PM-U24P		
	PM-U24-R		

Note: The suffix "-R" indicates a flexible cable type.

Order Guide

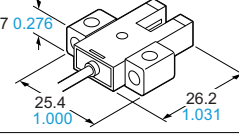
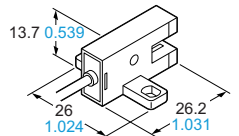
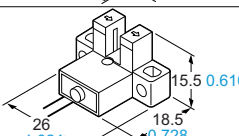
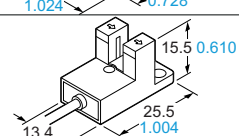
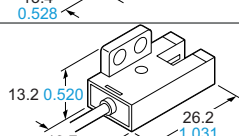
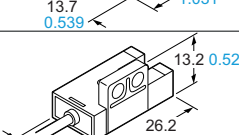
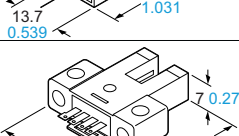
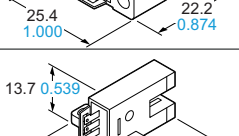
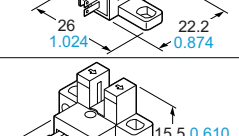
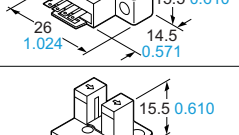
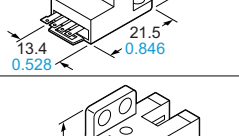
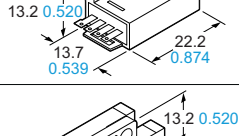
Type	Appearance (mm in)	Sensing range	Model no.	
Small	With cable	5 mm (fixed)	K type	 PM-K44 PM-K44P
			T type	 PM-T44 PM-T44P
			L type	 PM-L44 PM-L44P
			Y type	 PM-Y44 PM-Y44P
			F type	 PM-F44 PM-F44P
			R type	 PM-R44 PM-R44P
	With connector		K type	 PM-K54 PM-K54P
			T type	 PM-T54 PM-T54P
			L type	 PM-L54 PM-L54P
			Y type	 PM-Y54 PM-Y54P
			F type	 PM-F54 PM-F54P
			R type	 PM-R54 PM-R54P

PM Order Guide

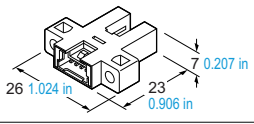
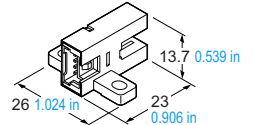
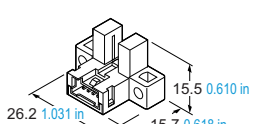
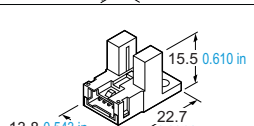
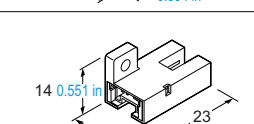
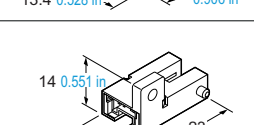
Type	Appearance (mm in)	Sensing range	Model no.
Small and built-in connector type	 <p>26 1.024 in, 23 0.906 in, 7 0.207 in</p>	5 mm (fixed)	PM-K64
			PM-K64P
	 <p>26 1.024 in, 23 0.906 in, 13.7 0.539 in</p>		PM-T64
			PM-T64P
	 <p>26.2 1.031 in, 15.7 0.618 in, 15.5 0.610 in</p>		PM-L64
			PM-L64P
	 <p>13.8 0.543 in, 22.7 0.894 in, 15.5 0.610 in</p>		PM-Y64
			PM-Y64P
	 <p>14 0.551 in, 23 0.906 in, 13.4 0.528 in</p>		PM-F64
			PM-F64P
	 <p>14 0.551 in, 23 0.906 in, 13.4 0.528 in</p>		PM-R64
			PM-R64P

Options

Designation	Model no.	Description
Connector	CN-14	Connector for soldering
Hook-up connector	CN-14H	This connector can be hooked-up on 0.08 to 0.2 mm ² cable simply in one grip. Wire diameter: $\phi 0.7$ to $\phi 1.2$ mm $\phi 0.028$ to $\phi 0.047$ in
	CN-14H-2	Suitable for UL standard cable. This connector can be hooked-up on 0.18 to 0.22 mm ² cable simply in one grip. Wire diameter: $\phi 1.2$ to $\phi 1.52$ mm $\phi 0.047$ to $\phi 0.060$ in
Connector attached cable	CN-14H-C1	Length: 1 m 3.281 ft Net weight: 20 g approx.
	CN-14H-C3	Length: 3 m 9.843 ft Net weight: 65 g approx.
Hook-up pliers	CN-HP	For the connector type, with 0.18 mm ² 4-core cabtyre cable Cable diameter: $\phi 3.8$ mm $\phi 0.150$ in These are exclusive pliers for hook-up connectors CN-14H and CN-14H-2

■ Connector

- CN-14

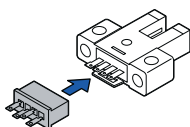

■ Hook-up connector

- CN-14H
- CN-14H-2

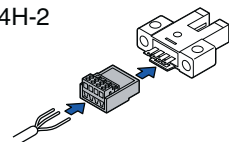

■ Connector attached cable

- CN-14H-C1
- CN-14H-C3

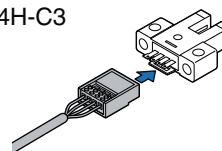

■ Hook-up pliers

- CN-HP

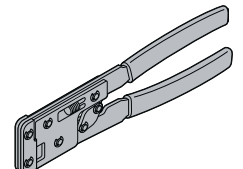

PM2



Convergent reflection sensing ensures stable detection

Features

■ Stable detection by convergent reflective mode

Stable detection characteristics are obtained since it is a convergent reflective type and senses a limited area.

■ Not affected by background

Even a specular background does not affect the sensing performance if the sensor is located 30mm away from it (when directly opposite).

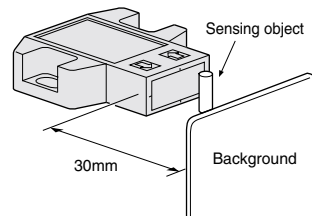

■ Sensing printed circuit boards

Minute object detectable.

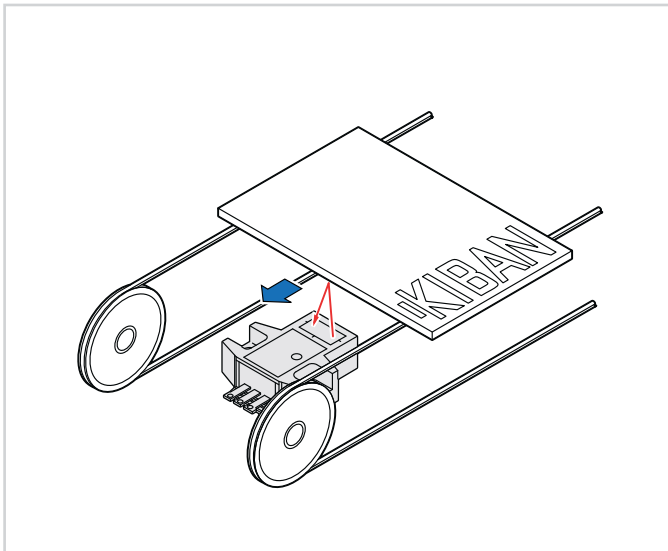

■ Dark object detectable

Since the sensor is very sensitive, it can detect even a dark object of low reflectivity.

■ Minute object detectable

A $\varnothing 0.05\text{mm}$ copper wire can be detected at a distance of 5mm.

■ Sensing the starting point and overrun of a moving body

Starting point and overrun is sensed using the dog on the base.

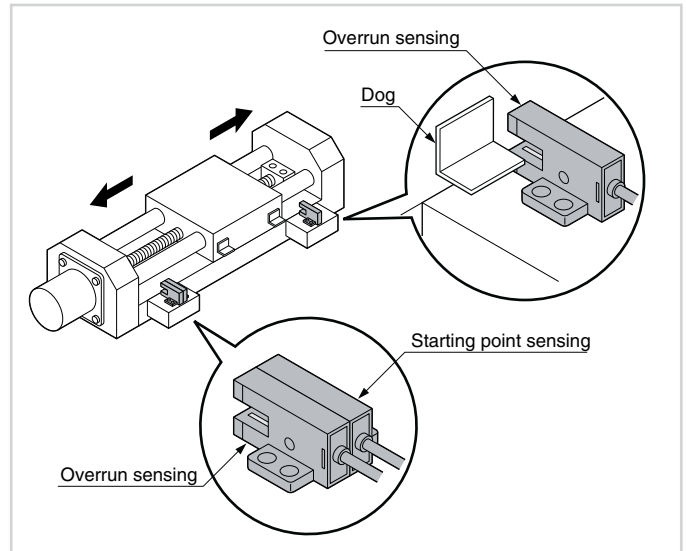

PM2 Typical Applications

Detecting capacitors in tray

The convergent reflective type sensor reliably detects capacitors in a tray without being affected by their color, characters, marks, or glossiness.

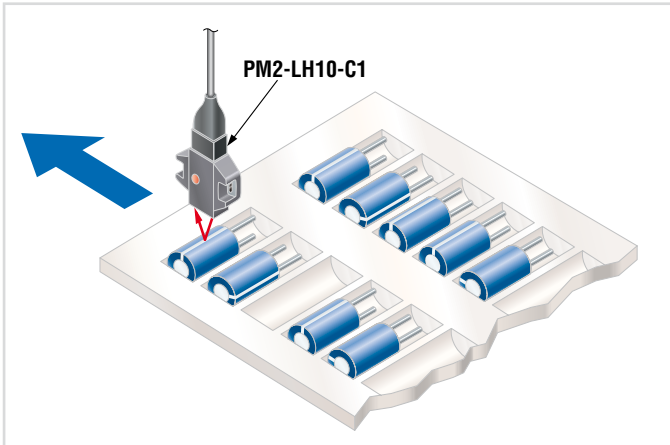

Order Guide

Type	Appearance	Sensing range	Model no.
Connector type	Top sensing	2.5 to 8mm	PM2-LH10
	Front sensing		PM2-LH10B
	L type (Top sensing)		PM2-LF10
Cable type	Top sensing		PM2-LF10B
	Front sensing		PM2-LL10
	L type (Top sensing)		PM2-LL10B
	Top sensing		PM2-LH10-C1
	Front sensing		PM2-LH10B-C1
	L type (Top sensing)		PM2-LF10-C1
			PM2-LF10B-C1
			PM2-LL10-C1
			PM2-LL10B-C1

Options

Designation	Model no.	Description
Connector	CN-14	Connector for soldering
Connector attached cable	CN-14H-C1	0.2mm ² 3-core cabtyre cable, 1m long
	CN-14H-C3	0.2mm ² 3-core cabtyre cable, 3m long

■ Connector

■ CN-13

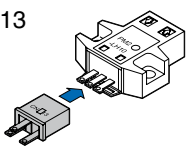

■ Connector attached cable

■ CN-13-C1

■ CN-13-C3

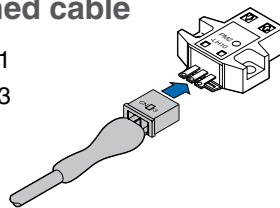

Technical Specifications

Type	Connector			Cable			
	Top sensing	Front sensing	L type (Top sensing)	Top sensing	Front sensing	L type (Top sensing)	
Model no.	Light-ON	PM2-LH10	PM2-LF10	PM2-LL10	PM2-LH10-C1	PM2-LF10-C1	PM2-LL10-C1
	Dark-ON	PM2-LH10B	PM2-LF10B	PM2-LL10B	PM2-LH10B-C1	PM2-LF10B-C1	PM2-LL10B-C1
Sensing range	2.5 to 8mm (conv. point: 5mm) with white non-glossy paper (15×15mm)						
Min. sensing object	∅0.05mm copper wire (setting distance: 5mm)						
Repeatability (perpendicular to sensing axis)	0.08mm						
Supply voltage	5 to 24VDC±10%						
Output	NPN open-collector transistor						
Response time	0.8ms or less						
Emitting element	Infrared LED (modulated)						

NA1-11



Cross-beam scanning system to detect slim objects

Features

■ Letter or business card detectable

Thin objects can be detected by using the cross-beam scanning system.

■ Emitting and receiving element pitch: 10mm

A minimum sensing object size of $\varnothing 13.5\text{mm}$ is realized by using an emitting and receiving element pitch of 10mm.

■ Wide area

Though very slim a wide sensing area of 1m length and 100mm width is realized. It is most suitable for object detection on a wide assembly line, or for detecting the dropping of, or incursion by, small objects whose travel path is uncertain.

■ Clearly visible large indicator

A clearly visible large indicator having a 55mm width is incorporated on both the emitter and the receiver.

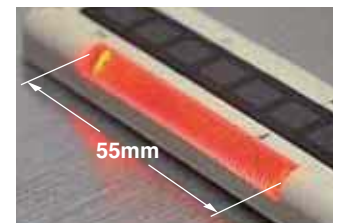
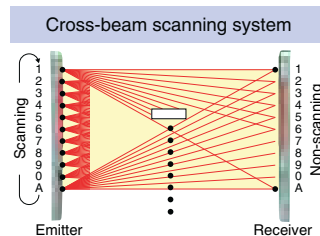

Typical Applications

Detecting postcards

NA1-11 can detect thin postcards due to its crossbeam scanning system.

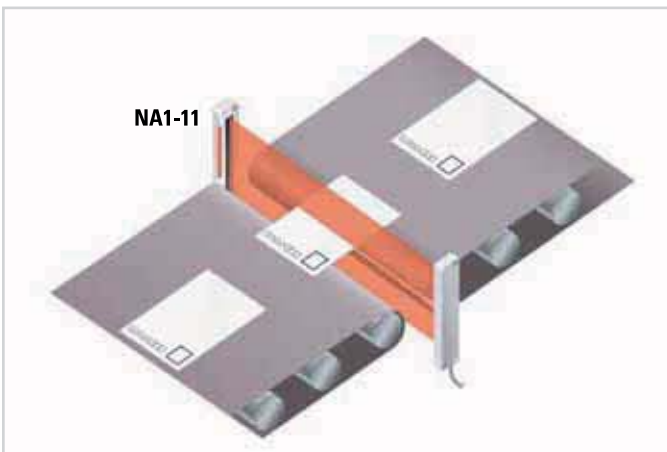

Technical Specifications

Model no.	NA1-11	NA1-11-PN
Sensing height	100mm	
Sensing range	0.17 to 1m	
Element pitch	10mm	
Number of emitting/receiving elements	11 each on the emitter and the receiver, respectively	
Sensing object	$\varnothing 13.5\text{mm}$ or more opaque object	
Supply voltage	12 to 24VDC $\pm 10\%$	
Output	NPN open-collector transistor	PNP open-collector transistor
Ambient temperature	-10 to +55°C	
Dimensions	W30×H140×D10mm	

NA1-PK5/ NA1-PK3

Ultra-slim body pick-to-light sensor



Features

■ 10 mm thick: half the thickness of conventional models

Space saving now possible; ultra-thin design does not obstruct picking operations.



Cable can be freely arranged in any position

■ Two unit installations are possible

Sensor units can now be set to different light emission frequencies in order to prevent mutual interference.

Two units can now be operated in a side-by-side configuration without interference for problem-free detection over wider areas.

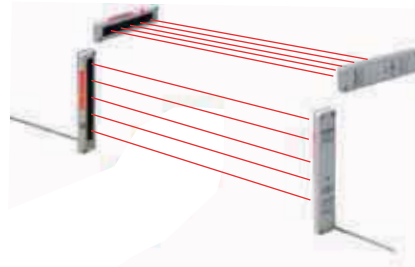

■ Lighting pattern selectable

The job indicator operation can be selected as either continuous lighting or blinking.

Continuous lighting



Blinking

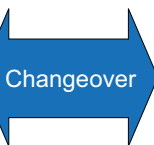

■ Selectable detection operation

Sensor units can be set to detect the interruption of 1 beam channel or 2 or more beam channels.

Single beam interruption

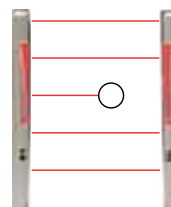

All opaque bodies with $\varnothing 35$ mm $\varnothing 1.378$ in or greater will be detected.

Double beam interruption

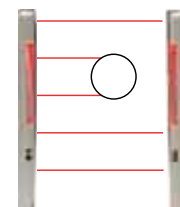

The accidental passage of small objects through the beam axis will not trigger detection, yet the operator's hands will always be accurately detected. This function is also useful when small objects regularly interrupt the beam axis.



Typical Applications

■ Cell production line



■ Assembly line



Technical Specifications

	NPN output		PNP output	
	NA1-PK5	NA1-PK3	NA1-PK5-PN	NA1-PK3-PN
Sensor type	Picking sensor			
Sensing height	100mm	49.2mm	100mm	49.2mm
Sensing range	0.1 to 1.2m	0.03 to 0.3m	0.1 to 1.2m	0.03 to 0.3m
Beam pitch	25mm	24.6mm	25mm	24.6mm
Number of beam channels	5 beam channels	3 beam channels	5 beam channels	3 beam channels
Sensing object	≥ Ø 35mm or more, opaque object	≥ Ø 29mm or more, opaque object	≥ Ø 35mm or more, opaque object	≥ Ø 29mm or more, opaque object
Supply voltage	12 to 24V DC ±10%			
Output	NPN open-collector transistor, max.100mA		PNP open-collector transistor, max.100mA	
Dimensions (W×H×D)	30×140×10mm	24×70×8mm	30×140×10mm	24×70×8mm

EQ-500



Long range sensing capability up to 2.5m

Features

1m sensing range type EQ-502(T)/512(T)

■ Impervious to variations in color or angle

Due to its advanced optical system, the sensor is not affected by variations in the object's angle or gloss as compared to conventional sensors. Moreover, sensing can be performed at a somewhat constant distance even if the sensing object is black or white.

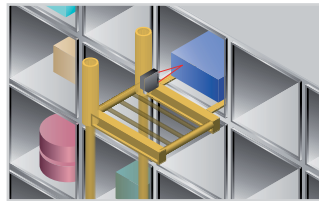

■ Not affected by background objects

Due to the 2-segment photodiode adjustable range system, the sensor does not detect objects outside the preset sensing field; it will not malfunction even if someone walks behind the sensing object, or machines or conveyors are in the background.

■ An easy-to-set adjuster with indicator

Equipped with a 2-turn adjuster with indicator, making it easy to set for short or long distances.

It can function with 24 to 240VAC and 12 to 240VDC. Therefore, almost any power supply anywhere in the world will work.

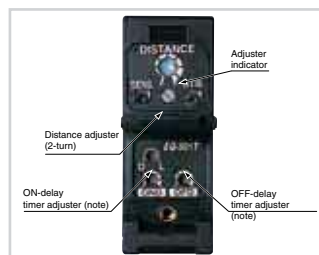

Multi-voltage type EQ-501(T)/502(T)

■ Equipped with BGS/FGS function

We have added a DC-voltage type with NPN and PNP transistor outputs, all in one sensor. Its BGS/FGS function controls any background effects for more stable sensing.

DC-voltage type EQ-511(T)/512(T)

■ Convenient timer function models

Types with an ON-delay/OFF-delay timer available. (EQ-5□T) OFF-delay, e.g. useful when the response of the connected device is slow, ON-delay, e.g. useful to detect objects that take a long time to move.

- Operation: ON-delay
OFF-delay
- Timer period: 0.1 to 5sec.
(individual setting possible)



■ Little affected by contamination on lens

Even if the lens surface gets somewhat dirty from dust particles, there is very little change in the operation field, rendering stable and consistent detection even for objects appearing close to the front surface of the unit.

■ Convenient terminal block type

Cabling is enabled by way of a terminal block that eliminates waste.



Technical Specifications

Type	Multi-voltage				DC-voltage			
	With timer		With timer		With timer		With timer	
Model. no.	EQ-501	EQ-501T	EQ-502	EQ-502T	EQ-511	EQ-511T	EQ-512	EQ-512T
Adjustable range (Note)	0.2 to 2.5m		0.2 to 1.0m		0.2 to 2.5m		0.2 to 1.0m	
Sensing range (at maximum setting distance)	0.1 to 2.5m		0.1 to 1.0m		0.1 to 2.5m		0.1 to 1.0m	
Supply voltage	24 to 240VAC \pm 10% or 12 to 24VDC \pm 10%				12 to 24VDC \pm 10%			
Output	Relay contact 1a				NPN open-collector transistor and PNP open-collector transistor 2 outputs			
Output operation	Switchable either Detection-ON or Detection-OFF							
Response time	20ms or less (for EQ-50XT dependent on the setting timer period)				2ms or less (for EQ-51XT dependent on the setting timer)			
Timer function	–	Incorporated with variable (0.1 to 5sec.) ON-delay / OFF-delay timer	–	Incorporated with variable (0.1 to 5sec.) ON-delay / OFF-delay timer	–	Incorporated with variable (0.1 to 5sec.) ON-delay / OFF-delay timer	–	Incorporated with variable (0.1 to 5sec.) ON-delay / OFF-delay timer
Protection	IP67 (IEC)							
Ambient temperature	–20 to +55°C							
Emitting element (modulated)	Infrared LED (modulated)							
Dimensions (W×H×D)	26×68×68mm							

EQ-30



EQ-30

Unaffected by color or material,
2m distance adjustable fixed-focus
sensing

Features

- Not affected by object color or background
- Long sensing range 2m
- Compact size

The EQ-30 saves space, since a miniaturized housing of 20×68×40mm (W×H×D) has been designed for the fixed-focus sensing sensor.

■ Two setting distances are possible: EQ-34W

With **EQ-34W**, two sensing distances, Far (Main) and Near (Sub), can be set. Hence, one sensor can suffice where previously two were required.

■ Plug-in connector type (excluding EQ-34W)

Plug-in connector type of the **EQ-30** series can be easily disconnected for replacement. Should a problem occur, anyone would be able to replace the sensor in a minute.

Technical Specifications

NPN output	EQ-34 (J)	EQ-34W *
PNP output	EQ-34PN (J)	
Sensor type	Diffuse	Diffuse/double output
Rated sensing distance	200cm	
Sensing range	10–200cm	Near: 10–200cm Far: 20–200cm
Standard detectable object	White drawing paper 20×20cm	
Detectable target	Transparent and opaque material	
Hysteresis	≤10% of measurement	
Response time	Max. 2ms	
Outputs	Transistor max. 100mA	
Emitting diode	Infrared LED 880nm	
Rated current consumption without load	NPN type: 50mA PNP type: 55mA	2 x NPN type: 90mA
Housing material	Plastic	
Protection	IP67	
Physical size (H×W×D)	68×20×40mm	
Connection method	2m cable or M12 connector (J)	
Operating voltage	10 to 30VDC (±10%)	
Usable ambient temperature	–20°C to +55°C	
Weight	Approx. 150g	

* (Two outputs)

Typical Applications

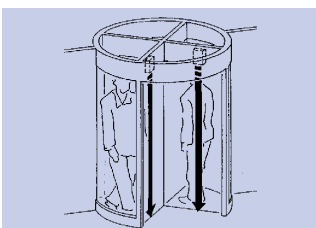

Long distance sensing

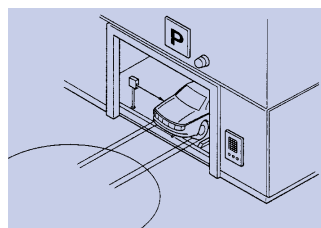

Object detection

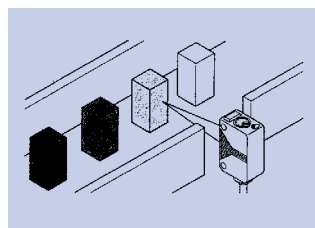

Color-independent presence sensing



MQ-W

Very accurate detection by triple beam triangulation sensing method in a compact package

Features

■ Accurate detection

Regardless of color, material, or shape of objects area reflective type sensor can detect white or black objects at the same distance. In case of diffuse reflective types, which cannot always detect objects of various color with the same sensitivity setting, the MQ-W area reflective type sensor is a worthy substitute.

■ No-miss operation regardless of backgrounds

Area reflective type sensors do not detect objects beyond the set range.

■ Resistant to lens surface soiling

Area reflective type sensors detect the distance by the angle, not the intensity of received light. Even if the lens surface is soiled by dust or powdery material, there is little variation in sensing range.

Technical Specifications

NPN output	MQ-W3A(R)	MQ-W20A(R)	MQ-W70A
PNP output	MQ-W3C(R)	MQ-W20C(R)	MQ-W70C
Sensor type	Diffuse		
Rated sensing distance	3cm	20cm	70cm
Sensing range	2-4cm	4-20cm	20-70cm
Standard detectable object	White drawing paper		
	1×1cm	2×2cm	7.5×7.5cm
Detectable target	Transparent and opaque material		
Hysteresis	≤10% of measurement range	≤20% of measurement range	
Detection frequency	250Hz		
Response time	2ms		
Output relay	-		
Output transistor	Max. 100mA, NPN/PNP		
Wavelength of emitting diode	Type R: 660nm		880nm
	910nm		
Rated current consumption	Max. 30mA		
Housing material	Zinc die cast		
Protection	IP67		
Physical size (H×W×L)	32×12.6×32mm		52×18.6×52mm
Connection method	2m cable		
Operating voltage	12 to 24VDC (-20% / +25%)		
Usable ambient temperature	-25°C to +55°C		
Weight	Approx. 126g		Approx. 235g

Typical Applications

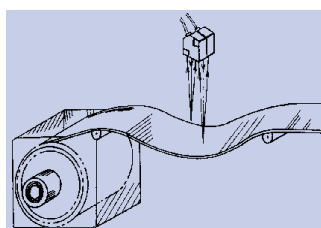

Distance detection

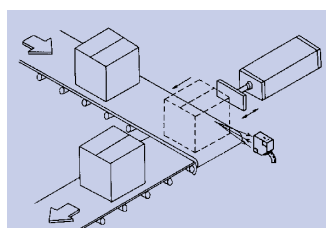

Position detection

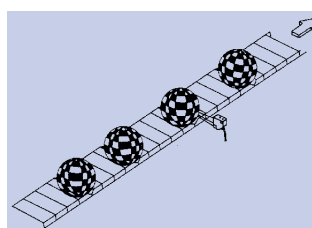

Color-independent detection

ST4



ST4

Type 4 · PLe · SIL3

Excellent basic functions at a reasonable price

Features

■ Series connection of 6 sets of sensor heads to 1 controller

The new concept of connecting 6 sets of sensor heads to 1 controller in series offers you maximum flexibility to solve your safety application.

■ Beam axis alignment and operation confirmation

The beam interruption indicator is incorporated in both the emitter and receiver. This indicator can be used not only to confirm operation but also to align the beam axis.

■ Compact sensor head saves space

The size of the type 4 long sensing range type is similar to general purpose photoelectric sensors.

■ IP67 degree of protection

The sensor heads can be used safely even on lines where water splashes.

■ Interference prevention

The emission amount adjuster can be used to prevent interference to the surrounding sensors.

■ Supports both PNP and NPN polarities

A single unit supports both PNP and NPN polarities, easing stock management.

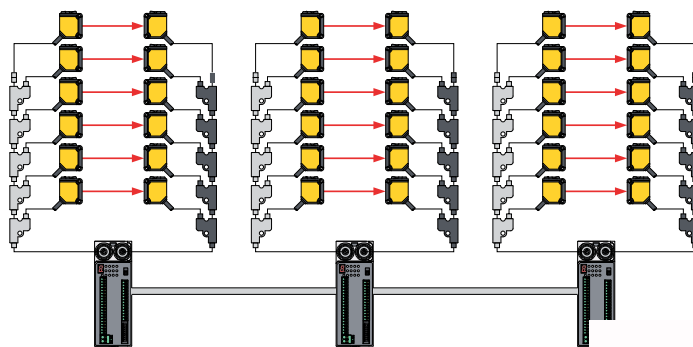
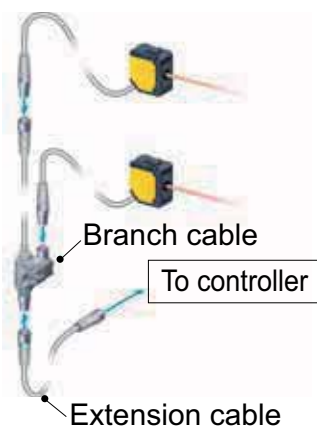

Typical Applications

Protection for long sensing ranges

Guard areas up to 15m in length, for example where protective fences are difficult to install.

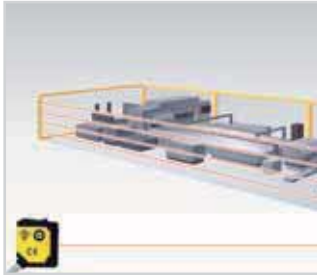

Protection for small openings

For small openings where light curtains do not fit, ST4 sensor heads ensure safety.



Protection against non-authorized entry

Sensor heads can be mounted flexibly and muting control implemented easily.



Technical Specifications

Sensor Heads	Cable length 0.2m		Cable length 1m	
		With emission amount adjuster		With emission amount adjuster
Model no.	ST4-A1-J02	ST4-A1-J02V	ST4-A1-J1	ST4-A1-J1V
Operating range	0.1 to 15m			
Sensing object	ø9 mm or more opaque object			
Supply voltage	Supplied from controller			
Current consumption	Emitter: 11mA or less, Receiver: 9mA or less			
Protection	IP67			
Weight	45g		100g	
Usable ambient temperature	-10 to +55 °C (No dew condensation or icing allowed), Storage: -25 to +70°C			
Emitting element	Infrared LED (Peak emission wavelength: 870nm)			
Material	Enclosure: PBT (Polybutylene terephthalate), Lens: Acrylic, Indicator cover: Acrylic			
Cable	Shielded cable with connector, 0.2m long		Shielded cable with connector, 1m long	
Safety category	EN 13849-1 (Category 4)			

Sensor type	Controller	High-functional controller
	ST4-C11	ST4-C12EX
Supply voltage	24VDC +10/ -15% Ripple P-P 10% or less	
Current consumption	100mA or less (excluding sensor heads)	120mA or less (excluding sensor heads)
Output transistors	OSSD1 and OSSD2 (PNP or NPN, switchable), max. 200mA	
Response time	ON -> OFF: 25ms or less OFF -> ON: 90ms or less (auto reset) / 140ms or less (manual reset)	
Protection	Enclosure: IP40 (IEC), Terminal: IP20 (IEC)	
Ambient temperature	-10 to +55 °C (No dew condensation or icing allowed), Storage: -25 to +70°C	
Material	Enclosure: ABS	
Weight	180g	240g

SF2B

Type 2 · PLd · SIL2



Excellent basic functions at a reasonable price

Features

■ Unit length = Protective height, 'ZERO' dead zone

Non-wasteful installation is possible, with no dead corners in the sensing width.



■ Also suppresses mutual interference and effects of extraneous light

The tried and proven ELCA function suppresses operating errors resulting from mutual interference and the effects of extraneous light, and prevents drops in line efficiency rates from occurring.



■ Seamless structure using an inner enclosure

The internal unit fits into an inner enclosure completely eliminating seams (joints) inside the product.

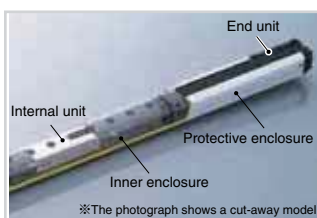

■ Supports resolution of electrical problems when starting up lines

Equipped with a digital error indicator so that error details can be understood at a glance!

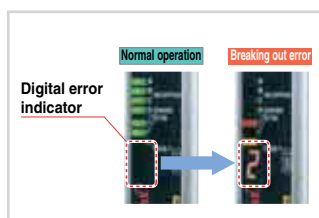

Technical Specifications

Type	Hand protection type		Arm / Foot protection	
	NPN output	PNP output	NPN output	PNP output
Model no.	SF2B-H□-N	SF2B-H□-P	SF2B-A□-N	SF2B-A□-P
Safety category	Type 2, PLd, SIL2			
Beam pitch	20mm		40mm	
Operating range	0.2 to 13m			
Protective height	168 to 1912mm			
Min. sensing object	∅27mm opaque object		∅47mm opaque object	
Supply voltage	24VDC ±10%			
Control output	NPN output type: NPN open collector transistor PNP output type: PNP open collector transistor			
Response time	OFF response: 15ms or less, ON response: 40 to 60ms			
Ambient temperature	-10 to +55°C			
Dimensions	W28×H protective height×D24mm			

SF4B<V2>

Type 4 · PLe · SIL3

New concepts combining greater safety and higher productivity!

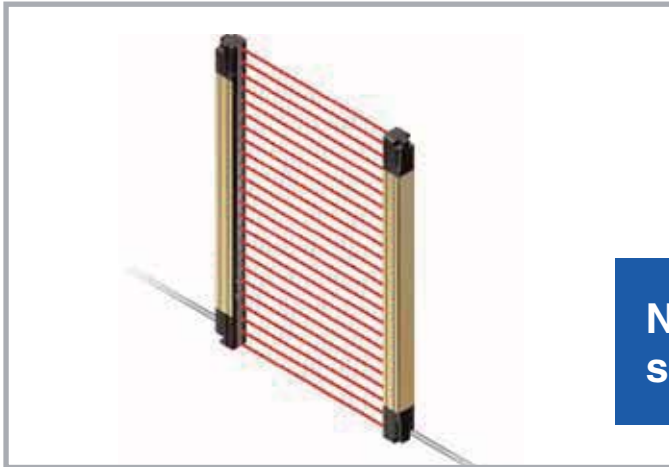

Features

■ 'ZERO' dead zone

The length of the main unit equals the protective height so that installation is possible in places where space is limited. No dead zone occurs at the joints between light curtains when light curtains are connected in series.

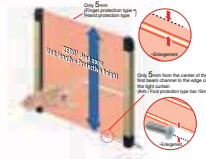

■ 3 types available for different workplace conditions



■ Same response time of 14ms and constant safety distance

A fast response time of 14ms has been achieved regardless of the number of beam channels, the beam axis pitches and the number of units connected in series. This reduces calculation work required for the safety distances.

■ A muting control function is provided to increase without compromising safety productivity

The light curtain is equipped with a muting control function that causes the line to stop only when a human body passes through the light curtain, and does not stop the line when a workpiece passes through.

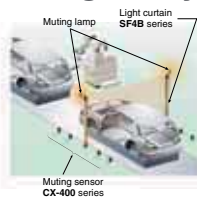

■ The safety relay unit capability is built into the light curtain so component costs can be reduced

The light curtain has a built-in external device monitoring function (such as for fused relay monitoring) and an interlock function. The safety circuit is constructed so that a separate safety relay unit is not needed, and the control board is also more compact, both of which contribute to lower costs.

■ Reduces malfunction due to mutual interference and extraneous light

The advanced ELCA function used in the SF4-A that has been widely acclaimed in the marketplace has also been adopted into the SF4B in order to suppress mutual interference. In addition, the unique double scanning method and retry processing greatly reduce malfunctions due to extraneous light.

■ Equipped with a digital error indicator

If an error occurs, details of the error appear on the digital display so that maintenance can be carried out more quickly.



■ Universal design that can be used anywhere in the world

The SF4B series combines PNP transistor output and NPN transistor output in a single model. Overseas equipment that uses PNP, replacement with NPN sensors, factories that are positively grounded, and transfer of equipment overseas are all situations where the control circuits for a single model are suitable for use worldwide.

Typical Applications

Guarding space around welding robot

The spatter protection hood type perfect for welding devices is also available.

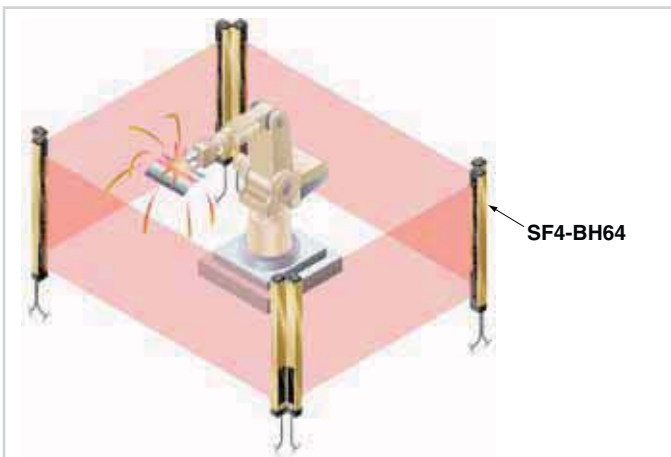

Technical Specifications

Type	Finger protection type	Hand protection type	Arm / Foot protection type
Model no.	SF4B-F□□<V2>	SF4B-H□□<V2>	SF4B-A□□<V2>
Safety category	Type 4, PLe, SIL3		
Beam pitch	10mm	20mm	40mm
Operating range	0.3 to 7m	0.3 to 9m (72 beam channels or more: 0.3 to 7m)	0.3 to 9m (36 beam channels or more: 0.3 to 7m)
Protective height	230 to 1270mm	230 to 1910mm	230 to 1910mm
Min. sensing object	14mm or more in opaque object	25mm or more in opaque object	45mm or more in opaque object
Supply voltage	24VDC±10%		
Control output	PNP open collector transistor / NPN open collector transistor (selectable using wiring)		
Response time	OFF response: 14ms or less, ON response: 80 to 90ms		
Dimensions	W28×protective height×D30mm		

□□ Number of beams

40th Anniversary MODEL

SF4C

Type 4 · PLe · SIL3

SF4C

New

Ultra-slim light curtain machines safeguards without sacrificing productivity

Features

Large built-in multi-purpose indicators

Large LED bars on each side of the light curtain provide a wide visibility indicator that can be customized for various applications by means of independent external inputs. The indicator can be used as an operation indicator, job indicator, etc.

Slim size for efficient applications

Available work space is expanded from the previous model, and productivity is improved.

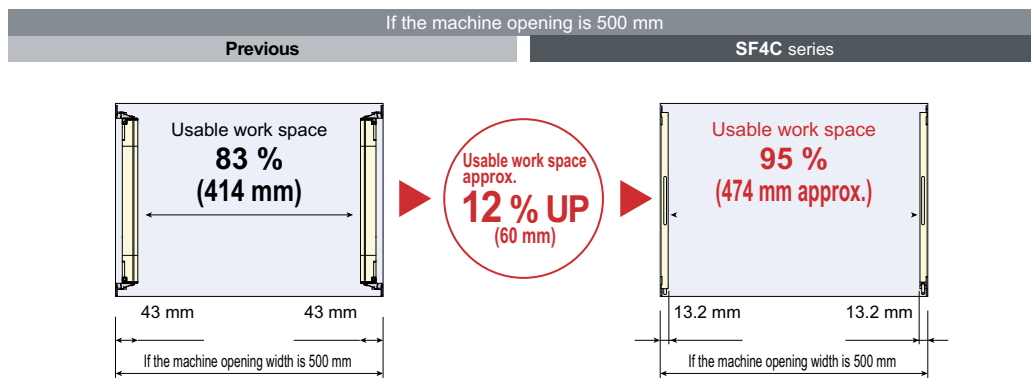

Can be used in a variety of applications for simplified equipment (Large multi-purpose indicator)

The bright LED indicators located in the center of both sides of each light curtain can be illuminated green or red by using external inputs. There is no need to set up a separate indicator..

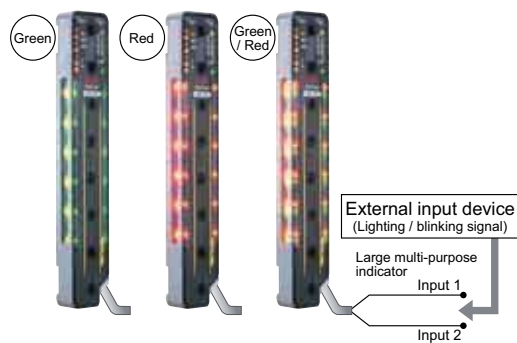
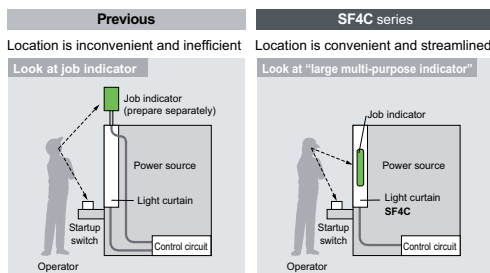

SF4C ■ Wire-saving when connecting to safety devices [safety input functions]

Contact outputs such as emergency stop switches or safety door switches can be connected to the light curtain. Also, by using the handy-controller **SFC-HC**, up to three sets of light curtains can be cascade connected for a consolidated safety output.

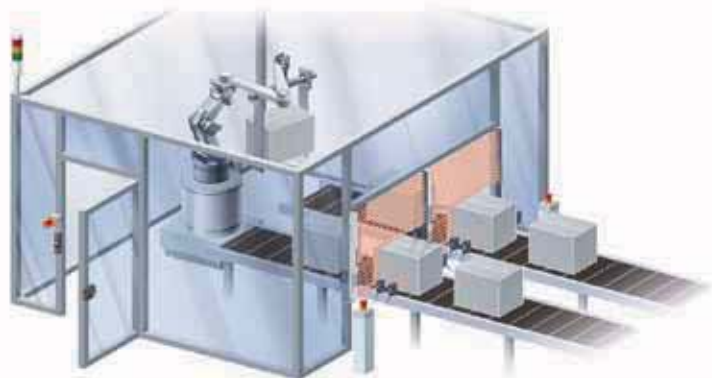

■ Direct connection of safety devices

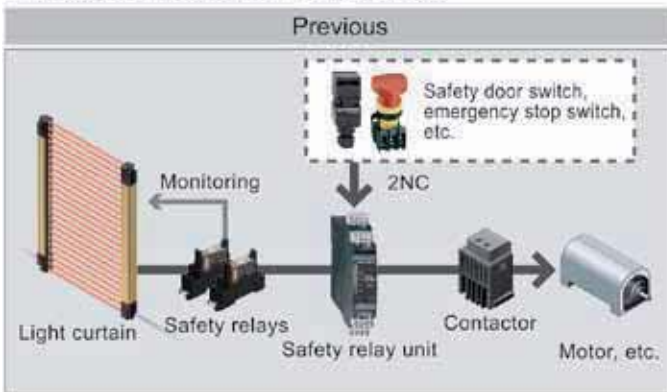

A safety relay unit is needed for connecting safety devices other than light curtain.

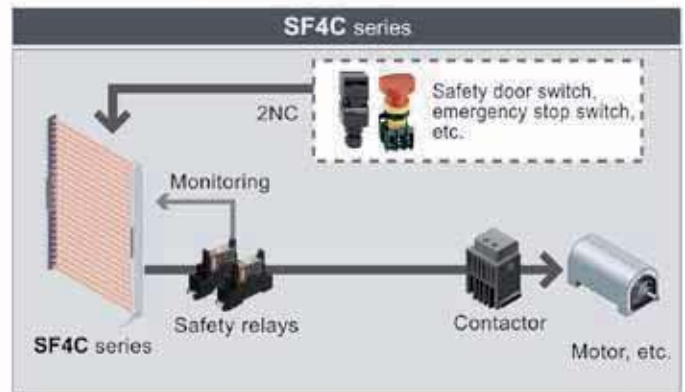

Direct connection of various safety devices is possible for a simplified safety circuit.

■ By using the handy-controller SFC-HC (available soon) up to three sets of light curtains can be cascade connected for a consolidated safety output. **HC**

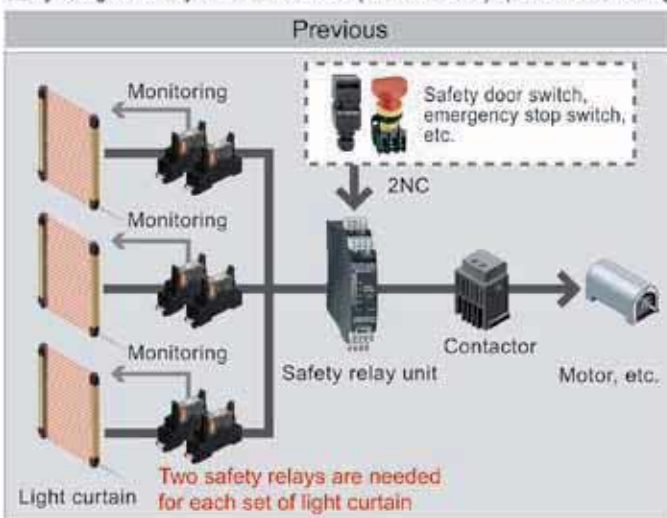

Three sets of light curtains require three sets of safety relays.

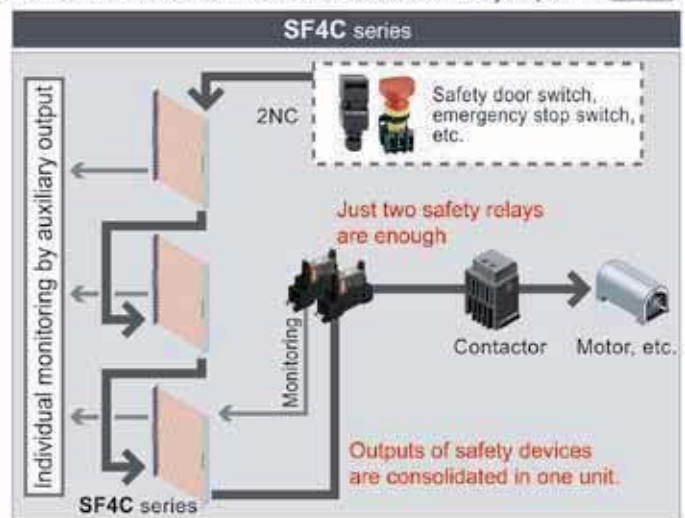

Individual monitoring on light curtains is possible while the outputs of three sets of light curtains and other safety devices are consolidated in one unit.

■ IP67 protection structure

An IP67 (IEC / JIS) rating is achieved with an ultra-slim size for protection from environmental factors.

■ Mutual interference is reduced without needing interference prevention lines

The light curtain is equipped with the ELCA (Extraneous Light Check & Avoid) function, which has been proven to be strong against mutual interference. Because it automatically shifts the scan timing of the light curtain in order to avoid interference, it is not necessary to wire interference prevention lines between machinery.

■ Safety, productivity, and cost reduction [muting control function]

The light curtain has a built-in muting control function that causes the line to stop only when a person passes through the light curtain, and does not stop the line when an object passes through. The muting sensors and muting lamps can be connected directly to the light curtain. Furthermore, the large multi-purpose indicators can be used as muting lamps, which contribute to less wiring troubles, improvement of safety and productivity, and cost reduction.

■ A fast response time of 7ms* for all models

A fast response time of 7ms* is unified for all models regardless of the number of beam channels. This reduces the safety distance as well as the calculation work required for the safety distance among models with different beam channels.

* When connecting safety sensors (light curtains, etc) to the safety input, the response time will be the total time of connected units.

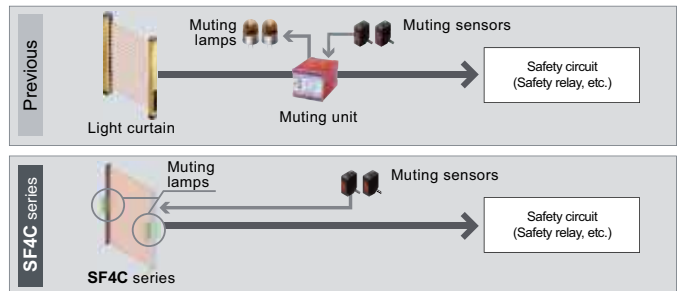

* If a failure diagnosis of muting lamp is needed as by the result of risk assessment, use the handy-controller **SFC-HC** to change the setting, and connect the muting lamp output wire (red) of this light curtain to an incandescent lamp separately.

Typical Applications

Use a muting lamp

There is no need to buy and install a separate muting lamp.



Selective muting area

Separate muting control function for each beam channel.



Industry first!

Wire-saving when connecting to safety devices (safety input function)



SF4C Technical Specifications

	SF4C pigtailed type	SF4C cable type
Type	Hand protection type	
Beam pitch	20mm	
Safety category	Type 4, PL _e , SIL3	
Operating range	0.1 to 3m	
Protective height	160mm to 640mm	
Min. sensing object	∅25mm or more in opaque object	
Supply voltage	24V DC (+10/-15%)	
Control output	OSSD1 and OSSD2 (2xPNP or 2xNPN, switchable), max. 200mA	
Response time	OFF response: 7ms or less / ON response: 90ms or less	
Dimensions	W13,2 x protective height x 30mm	

SD3-A1

Type 3 · PLd · SIL2



Monitor dangerous areas for unauthorized entry using flexible detection zones!

Features

■ Freely configurable zones

Two zones can be monitored with the SD3-A1: the warning zone within a radius of 15m, and the protection zone within a radius of 4m. You can configure the contours of these zones to perfectly accommodate any application. You can configure up to eight zone patterns and switch between them at any given time, even during operation. This flexible zone configuration can be done by PC.



Compatible OS: Windows XP/2000/
NT/98/95

Note: Windows is a registered trademark or trademark of Microsoft Corp. in the U.S. and/or other countries.

■ Monitors beam misalignment after installation of safety laser scanner

By activating the reference boundary function which enables constant detection of stationary objects, the safety laser scanner memorizes the position of stationary objects, and monitors for beam misalignment after installation.

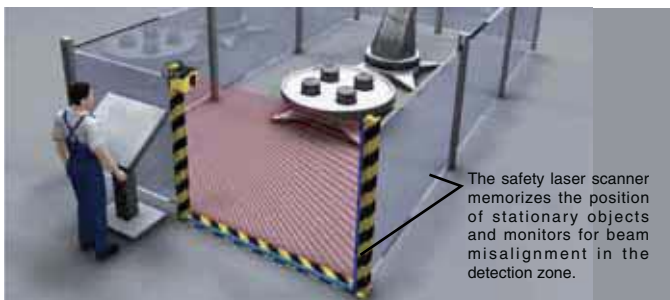

■ Adjustment of response times enables interference prevention

The response time can be adjusted from 80 to 640ms. Mutual interference can be prevented by adjusting the response time when setting up multiple safety laser scanners in close vicinity.



■ Memorized configurations make post-maintenance recovery easy (optional)

Configurations can be saved in the optional configuration plug's built-in memory and reloaded after maintenance or exchanging safety laser scanners.

Typical Applications

Detecting entry into dangerous areas at processing machines

Warning and machine halt zones are implemented to detect workers in dangerous areas.



Confirming safety around automatic guided vehicles

The scanner is used to slow down the vehicle upon detection in the warning zone and stop the vehicle upon entering the protection zone.

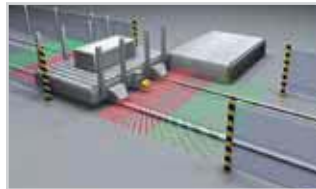

Detecting presence in a defined field

Install two safety laser scanners to build a protection zone surrounding the object in question. Deactivating the zone is also possible.



Guarding the sides of automatic guided vehicles (AGV)

Prevent injuries from a moving AGV. Monitor fallen cargo to avoid collisions.



Detecting entry into dangerous areas of circular cycle tables

One safety laser scanner can safeguard the front opening where in the past two sets of light curtains were needed.



Detecting entry into areas with robots

The scanner detects a human body whenever it enters the field.



Technical Specifications

Type	Safety laser scanner					
Model no.	SD3-A1					
Safety category	Type 3, PLd, SIL2					
Detection zone	Min. sensing object setting	ø150mm	ø70mm	ø50mm	ø40mm	ø30mm
	Sensing range (radius)	0 to 4.0m	0 to 4.0m	0 to 2.8m	0 to 2.2m	0 to 1.6m
Warning zone	Min. sensing object setting	ø150mm (fixed)				
	Sensing range (radius)	0 to 15m				
Scanning angle	190° / 180° (by setting)					
Measurement zone	Max. measurement range (radius) 50m (fixed)					
Number of zone settings	Max. 7 + 1 (without detection zone)					
Min. zone setting range	200mm					
Supply voltage	24V DC+20 -30%					
Current consumption	300mA approx. (excluding external connection load)					
Control outputs (OSSD 1, OSSD 2)	PNP open-collector transistor 2 outputs Rated operating voltage: supply voltage (UB) -3.2V Max. source current: 250mA Residual voltage: 3.2V or less					
Laser protection class	Class 1 (IEC 60825)					
Degree of protection	IP65					
Ambient temperature	0 to +50°C, Storage: -20 to + 60°C					
Material	Main body: Die-cast aluminium, Scanner window: Thermoplastic resin					
Accessories	SD3-PS (exclusive 15-pin connector): 1 pc., SD3-RS232 (exclusive 9-pin connector): 1 pc., Mounting screws [M5 (length 20 mm) hexagon-socket-head bolt: 2 pcs., M5 (length 16mm) hexagon-socket-head bolt: 2 pcs., attached to SD3-PS]; 1 set, Simplified instruction manual: 1 copy, Installation CD-ROM (includes detailed instruction manual data): 1 CD					
Weight	Net weight: 2.1kg approx., Gross weight: 2.9kg approx.					

SF-C10

SF-C10



Less setup time for safety light curtains

Features

■ Supports both PNP and NPN polarities

A single unit can be used for PNP / NPN input switching, reducing the number of parts that need to be registered.

■ Removable terminal blocks reduce maintenance time

SF-C11, SF-C14EX(-01)

Removable terminal blocks are used. This reduces the work required for reconnecting wiring during maintenance.



■ Metal enclosure with an IP65 protective structure

SF-C12

The strong metal enclosure has a built-in safety relay. It has an IP65 protective structure so that it can be set up individually without needing to be inserted into a control panel.

■ Slim design

SF-C13

22.5mm thickness for insertion even into narrow spaces inside panels.

■ Three safety circuit systems packaged into a single unit!

SF-C14EX(-01)

Three safety circuit systems, light curtain output circuit, muting control circuit, and emergency stop circuit, are packaged into a single unit. This allows safety to be maintained for different sections of the equipment.

FM-200



Flow sensor with dual display

Features

■ Easy-to-read, 2-color display with sub display

The setting conditions appear on the sub display, making it much easier to keep track of operations. In addition, the 2-color or digital display lets you check the sensor's operation status at a glance.

■ High precision of $\pm 3\%$ F.S.

A new rectification mechanism and Micro Electro Mechanical System (MEMS) technology allow the sensor to be mounted on a silicon sensor chip and result in an extremely small heat capacity, high precision of $\pm 3\%$ F.S. and high-speed response. Two temperature sensors, one on either side of the heater, detect heat distribution and make bidirectional detection possible.

■ One sensor for both intake and exhaust

A single sensor can detect flows bidirectionally, or the forward or reverse direction only, making it suitable for a variety of applications.

■ Integrated output and pulse output mode incorporated

The FM-200 series can control and manage flows for a wide variety of applications. The integrated output mode will turn the output ON or OFF at the specified integrated value, allowing you to control air blowing volumes, for example. In pulse output mode, a pulse is generated once at each specified integrated value, allowing you to monitor the amount of air consumed, for example.

■ Economical, ecological

The pulse output can be input to the pulse counter of an Eco-POWER METER so that air consumption and power consumption can be measured simultaneously.

■ Integrated value reset function

During integrated mode, an external input can reset the integrated value.

■ Analog voltage output

1 to 5V analog voltage output is incorporated.

■ Key lock function

Key operation can be disabled to prevent inadvertent operation.

■ Rattle prevention function

To prevent rattling from rapid changes in flow or from noise, the response time can be set to one of seven steps from 50ms to approximately 1,500ms.

■ Display rate setting

The display update period can be changed to 250ms, 500ms or 1,000ms in order to eliminate flickering.

■ ECO mode

In ECO mode, the backlight is turned off after approximately 1 minute if no operation occurs to reduce power consumption.

Typical Applications

Checking suction



Checking seating



Technical Specifications

PNP	FM-252-4-P	FM-213-4-P	FM-253-4-P	FM-214-4-P	FM-254-8-P	FM-215-8-P
NPN	FM-252-4	FM-213-4	FM-253-4	FM-214-4	FM-254-8	FM-215-8
Sensor type	Digital flow sensor					
Full scale flow rate	500ml/min	1l/min	5l/min	10l/min	50 l/min	100 l/min
Display range (bar)	±9999999ml		±99999.99l		±999999.9l	
Setting and display resolution	1ml/min		0.01l/min		0.1 l/min	
Rated pressure range	-0.09 to +0.7 MPa					
Pressure resistance (bar)	1Mpa					
Applicable fluid	Clean air, compressed air, nitrogen gas					
Linearity	3%F.S.					
Response time	50ms to 1.5s selectable					
Transistor output	Max. 50mA					
Output modes	Output OFF mode, window comparator mode, hysteresis mode, integrated output mode, integrated pulse output mode					
Analog voltage output	1.0 to 5.0V					
Rated current consumption	Normal mode: 60mA or less, ECO mode: 40mA or less					
Housing material	Resin body type					
Protection	IP40					
Physical size (HxWxL)	37x55x17mm				43x55x17mm	
Connection method	Connector					
Operating voltage	12 to 24VDC ± 10%					
Ambient temperature	0 to + 50°C					
Temperature characteristics	Within ±0.2% F.S./°C (+15°C to +35°C)					
Weight	Net weight: 50g approx.				Net weight: 70g approx.	
Port size	ø4 push-in				ø8 push-in	

PNP	FM-255-AR2-P	FM-255-AG2-P	FM-216-AR2-P	FM-216-AG2-P
NPN	FM-255-AR2	-	FM-216-AR2	-
Sensor type	Digital flow sensor			
Full scale flow rate	500l/min		1.000l/min	
Display range (bar)	±9999999l			
Setting and display resolution	1l/min			
Rated pressure range	-0.09 to +0.7MPa			
Pressure resistance (bar)	1Mpa			
Applicable fluid	Clean air, compressed air, nitrogen gas			
Linearity	3%F.S.			
Response time	50ms to 1.5s selectable			
Transistor output	Max. 50mA			
Output modes	Output OFF mode, window comparator mode, hysteresis mode, integrated output mode, integrated pulse output mode			
Analog voltage output	1.0 to 5.0V			
Rated current consumption	Normal mode: 60mA or less, ECO mode: 40mA or less			
Housing material	Resin/Aluminum body type			
Protection	IP40			
Physical size (HxWxL)	50x80x30mm			
Connection method	Connector			
Operating voltage	12 to 24VDC ± 10%			
Ambient temperature	0 to + 50°C			
Temperature characteristics	Within ±0.2 % F.S./°C (+15°C to +35°C)			
Weight	Net weight: 155g approx.			
Port size	Rc½ female thread	G½ female thread	Rc½ female thread	G½ female thread

DP-100



DP-100

A new global standard, dual display

Features

- 'Current value' and 'threshold value' can be checked at the same time!

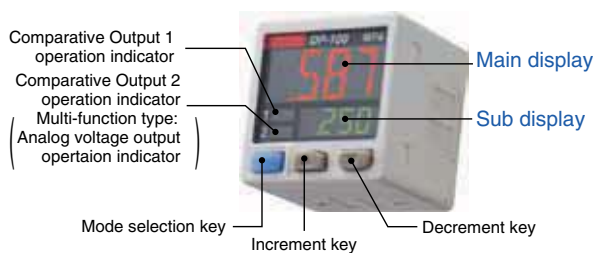

- Dual display allows direct setting of threshold value

Equipped with a 30mm square compact-sized dual display. Because the current value and the threshold value can be checked at the same time, the threshold value can be set and checked smoothly without having to switch screen modes.

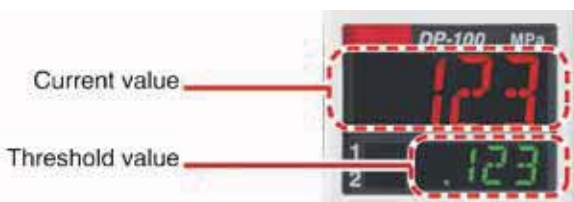

- 3-color display (Red, Green, Orange)

The main display changes color according to changes in the status of output ON/OFF operation, and it also changes color while setting is in progress. The sensor status can therefore be understood easily, and operating errors can be reduced.

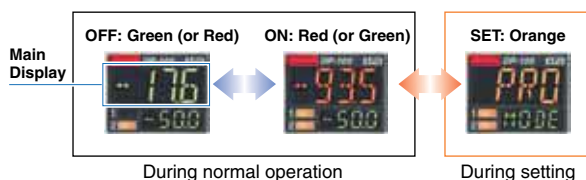

- Readable digital display!

12 segments are used and an alphanumeric display has been adopted. This improves visual checking of letters and numbers.



- Realizes high performance

Low pressure type

The low pressure type displays measurements in 0.1kPa at a resolution of 1/2000 and has a response time of 2.5ms (variable up to 5000ms), $\pm 0.5\%$ F.S. temperature characteristics and $\pm 0.1\%$ F.S. repeatability, giving it high performance.

- Copy function reduces man hours and human error

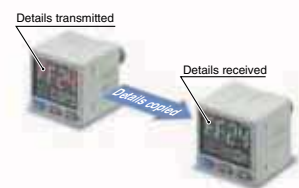

Sensors can be connected to a master sensor one by one, and a copy of the setting details for the master sensor can be transmitted as data to the other sensors. If making the same settings for multiple sensors, this prevents setting errors from occurring with the other sensors and also reduces the number of changes required to instruction manuals when equipment designs are changed.

- Equipped with auto-reference/remote zero-adjustment functions. More precise pressure management is possible with a minimum of effort

Multi-function type

If the reference pressure of the device changes, the auto-reference function partially shifts the comparative output judgment level by the amount that the reference pressure shifts, and the remote zero-adjustment function can reset the display value to zero via external input. These functions are ideal for places where the reference pressure fluctuates wildly, or where fine settings are desired.

Typical Applications

Confirming suction of electronic component



Confirming reference pressure



Air-leak test for PET bottles



Technical Specifications

Cable types

Type		Compound pressure				
		For low pressure		For high pressure		
Model no.		Multi-function				
		For low pressure		For high pressure		
Model no.	Asian	DP-101	DP-102	DP-101A	DP-102A	
	European	DP-101-E-P	DP-102-E-P	DP-101A-E-P	DP-102-E-P	
	North American	DP-101-N(-P)	DP-102-N(-P)	DP-101A-N(-P)	DP-102A-N(-P)	
	G 1/8 male thread	Short port type	DP-101-FE-P	DP-102-FE-P	DP-101A-FE-P	DP-102A-FE-P
	M5 female thread		DP-101-M-P	DP-102-M-P	DP-101A-M-P	DP-102A-M-P
Rated pressure range		-100.0 to +100.0kPa	-0.100 to +1.000kPa	-100.0 to +100.0kPa	-0.100 to +100.0kPa	
Applicable fluid		Non-corrosive gas				
Supply voltage		12 to 24VDC ±10%				
Output		NPN output type: NPN open-collector transistor PNP output type: PNP open-collector transistor				
Response time		2.5ms, 5ms, 10ms, 25ms, 50ms, 100ms, 250ms, 500ms, 1,000ms, 5,000ms, selectable by key operation				
Display		4 digits + 4 digits 3-color LCD display				
Pressure port		Asian: M5 female thread + R (PT) 1/8 male thread, European: M5 female thread + G 1/8 male thread, North American: M5 female thread + NPT 1/8 male thread				
Connecting method		Connector				
Accessories		CN-14A-C2 (Connector attached cable 2m): 1pc.				
Dimensions (W×H×D)		30×30×42.5mm				

M8 connector types

Type	Standard		Multi-function	
	For low pressure	For high pressure	For low pressure	For high pressure
Model. no.	DP-111-E-P-J	DP-112-E-P-J	DP-111A-E-P-J	DP-112A-E-P-J
Rated pressure range	-100.0 to +100.0kPa	-0.100 to +1.000 MPa	-100.0 to +100.0 kPa	-0.100 to +1.000 MPa
Applicable fluid	Non-corrosive gas			
Supply voltage	12 to 24VDC ±10%; Ripple P-P 10% or less			
Comparative output	PNP open-collector transistor			
Response time	2.5ms, 5ms, 10ms, 25ms, 50ms, 100ms, 250ms, 500ms, 1,000ms, 5,000ms, selectable by key operation			
Auto-reference function / Remote zero-adjustment function	—		Incorporated	
Analog voltage output	—		Incorporated	
Ambient temperature	-10 to +50°C, Storage: -10 to 60°C			
Pressure port	G1/8 male thread +M5 female thread			
Material	Enclosure: PBT (glass fiber reinforced); LCD display: acrylic; pressure port: stainless steel (SUS303); mounting threaded part: brass (nickel plated); switch part: silicone rubber, M8 connector part: brass • nickel plated (shell)/brass • gold plated (contact)			
Accessories	Unit selection plate: 1			

Note: Where measurement conditions have not been specified precisely, the conditions used were ambient temperature +20°C.

DPH-100 / DPC-100



DPH-100/ DPC-100

Single-axis type digital pressure sensor with optional dual 3-color display

Features

■ Direct installation using a hexagonal wrench

The sensor head is tightened with a hexagonal wrench, making installation easy, especially in tight spaces.

■ Dual display + Direct setting

The dual display allows you to check current and threshold values simultaneously.

To facilitate setting operations, three modes have been devised:

- "RUN mode" is for operation settings that are carried out daily
- "MENU SETTING mode" for basic settings
- "PRO mode" for special and detailed setting

Controllers can be connected to a master controller one by one, and the master can transmit settings to the slave controllers. This significantly reduces time required when you need to make multiple, identical settings, or during production change-overs. Moreover, it reduces the possibility for error in such cases.

■ Automatic sensor head recognition

The controller automatically recognizes sensor heads when they are connected, even if their rated pressure ranges are different.

Typical Applications

Checking suction



Reference pressure checking



Technical Specifications

Type	Pressure sensor							
	Compound pressure ±100 kPa type			Positive pressure 1 MPa type		Vacuum pressure -101 kPa type		
PN	DPH-101(-R)	DPH-101-M3(-R)	DPH-101-M5(-R)	DPH-102	DPH-102-M5	DPH-103(-R)	DPH-103-M3(-R)	DPH-103-M5(-R)
Type of pressure	Gauge pressure							
Rated pressure range	-100.0 to +100.0kPa			0 to +1.000Mpa		0 to -101.0kPa		
Pressure resistance	500kPa			1.5Mpa		500kPa		
Applicable fluid	Air, non-corrosive gas							
Supply voltage	12 to 24VDC ± 10% Ripple P-P 10% or less							
Analog voltage output	Output voltage: 1 to 5V (overrated pressure range)							
Protection	IP40 (IEC)							
Ambient temperature	0 to +50°C (No dew condensation allowed), Storage: -10 to +60°C							
Ambient humidity	35 to 85% RH, Storage: 35 to 85% RH							
Pressure port	DPH-10x(-R): R1/8 male thread + M5 female thread, DPH-10x-M3(-R): M3 male thread (for installing gasket) DPH-10x-M5(-R): M5 male thread (for installing gasket)							
Rated current consumption	15mA or less							
Housing material	Front case: PBT, Rear case: PBT (glass fiber reinforced), Pressure port: Stainless steel (SUS303)							
Connecting method	Connector							
Physical size (HxWxL), mm	23x13.2x 23.4	17x10x 20.5	17.5x10x 20.5	17x10x 20.5	17.5x10x 20.5	17x10x 20.5	17.5x 10x 20.5	
Weight	Net weight: DPH-10x(-R): Head 10g approx. / Cable 40g approx., DPH-10x-M3/M5(-R): Head 6 g approx. / Cable 40g approx. DPH-10x(-R): 80g approx., DPH-10x-M3/M5(-R): 70g approx.							
Accessory	Connector (e-CON): 1pc.							

Type	Controller	
	NPN output type	PNP output type
PN	DPC-101	DPC-101-P
Applicable sensor head	DPH-101x, DPH-102x, DPH-103x	
Rated pressure range	Compound pressure: -100.0 to +100.0kPa, Positive pressure: 0 to +1.000MPa, Vacuum pressure: 0 to -101.0kPa	
Supply voltage	12 to 24 VDC ± 10% Ripple P-P 10% or less	
Power consumption	Normal operation: 960mW or less (Current consumption 40mA or less at 24V supply voltage) ECO mode (STD): 720mW or less (Current consumption 30mA or less at 24V supply voltage) ECO mode (FULL): 600mW or less (Current consumption 25mA or less at 24V supply voltage) Excluding the current consumption of sensor head and analog output current	
Protection	IP40 (IEC)	
Ambient temperature	-10 to +50°C (No dew condensation or icing allowed), Storage: -10 to +60°C	
Ambient humidity	35 to 85% RH, Storage: 35 to 85% RH	
Material	Enclosure: PBT (glass fiber reinforced), LCD display: Acrylic, Mounting threaded part: Brass (nickel plated), Switch part: Silicone rubber	
Ambient humidity	35 to 85% RH, Storage: 35 to 85% RH	
Connecting method	Connector	
Cable length	Total length up to 100m is possible with cable of 0.3mm ² or more	
Weight	Net weight: approx. 25g (excluding connector attached cable), Gross weight: approx. 140g	
Accessories	CN-66A-C2 (Cable (2m) with attached connector), Pressure unit label: 1 set	

DP2



DP2

High-performance digital pressure sensors

Features

■ High accuracy, high resolution, high speed

The DP2 series achieves a 2.5ms or less response time at a high resolution of 1/1,000. It enables highly accurate sensing with its excellent repeatability and temperature characteristics.

■ Clearly visible LED display with 3.5 digits

Bright red LED 7-segment display having 3.5 digits, 10mm high. The displayed figures are remarkably noticeable not only in a dark area, but also in a well-lit place.

■ Setting with easy key operation

Initialization and threshold value settings are easily done by key operation while seeing the values on the display.

■ Selection from six pressure units

The pressure unit can be selected from six different systems to suit your requirement.

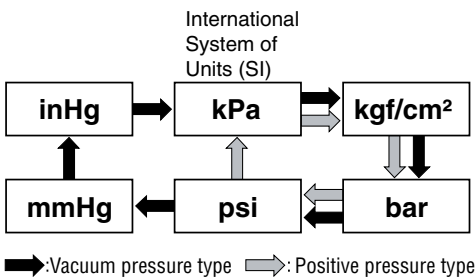

■ Four output modes enable versatile pressure level control

1) Hysteresis mode

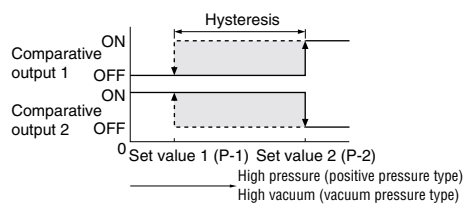

2) Window comparator mode

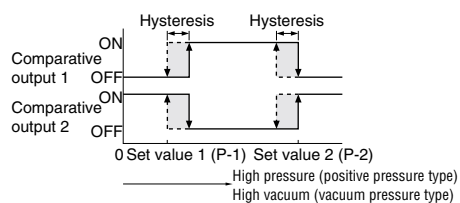

3) Dual output mode

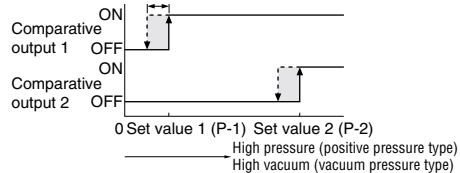

4) Automatic sensitivity setting mode

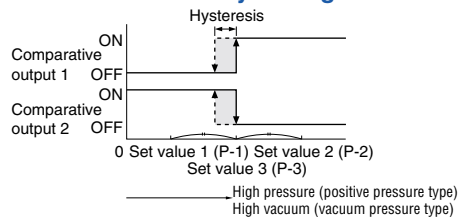

Technical Specifications

Type	Vacuum pressure				Positive pressure					
	- 101kPa type				100kPa type			1MPa type		
	Standard	Light weight	Flat	IP67	Standard	Flat	IP67	Standard	Flat	IP67
Asian	DP2-20	DP2-80	—	DP2-60	DP2-21	DP2-41	DP2-61	DP2-22	DP2-42	DP2-62
North American (Note)	DP2-20F (-P)	—	DP2-40N	DP2-60N	DP2-21F (-P)	DP2-41N	DP2-61N	DP2-22F (-P)	DP2-42N	DP2-62N
European	—	—	DP2-40E	DP2-60E	—	DP2-41E	DP2-61E	—	DP2-42E	DP2-62E
Type of pressure	Gauge pressure									
Rated pressure range	0 to -101.3kPa				0 to 100.0kPa			0 to 1.000MPa		
Applicable fluid	Non-corrosive gas									
Supply voltage	12 to 24VDC +10% /-15% Ripple P-P 10% or less									
Output	< Asian, North American (Standard NPN output, flat and IP67types)> NPN open-collector transistor					< North American (Standard PNP output type), European> PNP open-collector transistor				
Analog voltage output	Output voltage: 1 to 5 V (over rated pressure range) Zero-point: within 1 V ±5% F.S. Span: within 4 V ±5% F.S. Linearity: within ±1% F.S. Output impedance: 1kΩ approx.									
Pressure port	Asian	Standard, Flat and IP67 types: Rc (PT) 1/8 female thread, Light weight type: M5 female thread								
	North American	Standard type: , NPTF 1/8 female thread, Flat and IP67 types: NPT 1/8 female thread								
	European	Flat and IP67 types: G (PF) 1/8 female thread								
Housing material	Front case: ABS, Rear case: PPS (glass fiber reinforced), Display surface: Acrylic Pressure port attachment: Die-cast zinc alloy (Light weight type: POM (glass fiber reinforced), pressure port is brass (nickel plated)) Front cover (IP67 type only): Polycarbonate									
Weight	Standard type: 95g approx., Flat type: 120g approx., IP67 type: 370g approx., Light weight type: 70g approx.									
Accessories	Hexagon-socket-head plug for preure port: 1 pc. (Standard type only), Pressure unit label: 1 pc.									

Note: Model Nos. of North American standard type having the suffix "P" are PNP output type.

Typical Applications

Verifying proper workpiece seating

Air is supplied from under the base, and the pressure sensor checks for air leakage from any gap between the base and the workpiece.

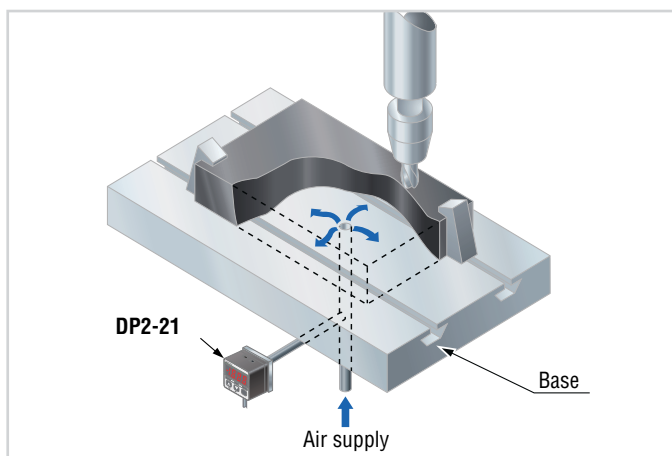

Detecting broken spool

The pressure sensor detects if a spool is chipped by sensing even slight air leakage in the air-supply system shown below.

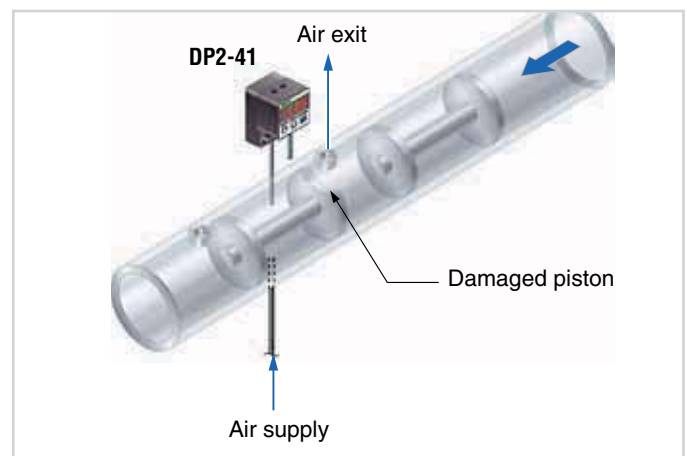

DP4



DP4

Suitable for panel installation due to new shape

Features

■ Lightweight, compact design

A compact form specifically designed for mounting on an equipment panel.

It uses only half the space of our conventional product and boasts the lightest weight of just 30g (cable excluded).

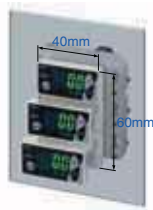

■ Supplied with a simple-to-mount panel mounting bracket

A panel mounting bracket (**MS-DP-1**) is enclosed to enable simple mounting of the sensor onto the panel surface, thus contributing to the total cost reduction.

■ Bright, easy-to-view 2-color digital display

The digital display is a large, easy-to-view 2-color digital display. It also functions as an output indicator as it changes from green to red when the output turns ON, enabling you to confirm the output status at a glance.

Typical Applications

Vacuum level confirmation for vacuum moulding

Detects the smallest air leaks from pinholes and other minute imperfections.

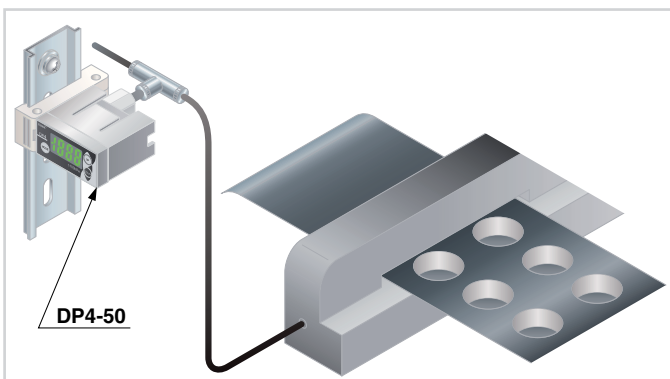

Confirming suction of wafer

While a wafer is being carried, the pressure sensor checks the vacuum level in the vacuum pad to verify that the wafer is being securely gripped.

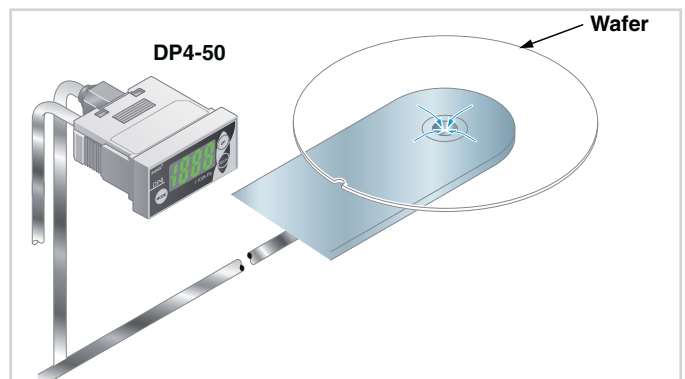

Technical Specifications

Type	Vacuum pressure		Positive pressure		Compound pressure	
	- 101kPa type		1MPa type		±100kPa type	
	NPN output	PNP output	NPN output	PNP output	NPN output	PNP output
PN	DP4-50	DP4-50P	DP4-52	DP4-52P	DP4-57	DP4-57P
Type of pressure	Gauge pressure					
Rated pressure range	0 to -101.3kPa		0 to 1.000MPa		-100.0 to 100.0kPa	
Applicable fluid	Non-corrosive gas					
Supply voltage	12 to 24VDC +10% /-15% Ripple P-P 10% or less					
Output	<NPN output type> NPN open-collector transistor			<PNP output type> PNP open-collector transistor		
Response time	2ms, 16ms, 128ms, 512ms or less (selectable by key operation)					
Protection	IP40 (IEC)					
Pressure port	M5 female thread					
Housing material	Front case: ABS, LCD display: PET, Rear case: PBT((M5 threaded part: Brass (nickel plated))					
Connecting method	Connector					
Weight	30g approx.					
Accessories	Panel mounting bracket (MS-DP-1): 1 set, Pressure unit label: 1 pc. Connector: 1 set (Housing: 1 pc., Connector pin: 3 pcs.)					

DP5/DPH



1/1000 second high-speed response

Features

■ Response time 1ms

Mounting the detachable head close to the detecting section minimizes piping and enables response time of 1ms, as well as greatly decreasing tact time delay. In addition, the ultra small and lightweight design of the head means it can easily be mounted on moving sections.

■ Sensor head with operation indicator

The sensor head is also equipped with an operation indicator. Output ON/OFF can be checked on the sensor head, so that it is suitable for checking operation at the suction head.

■ Lightweight, compact design

The controller inherits its lightweight, compact design from the popular **DP4** series of digital pressure sensors. Control panel setup is low cost and requires minimal space.

■ Convenient intermediate cable with connector

Intermediate cable with connectors for connecting the sensor head and the controller makes operation and maintenance easier.

Typical Applications

IC suction confirmation

With a light 6g head and a 1ms high-speed response time, it can be used with a high-speed mounter.



Verifying tightening of nut by impact wrench

The pressure sensor senses the back pressure of the impact wrench to verify that the nut is securely tightened.

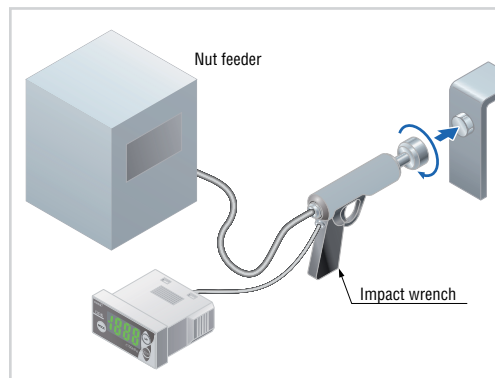

Verifying clamping pressure of welding hand

Since the pressure sensor incorporates two outputs, the clamping pressure can be classified into three levels: low, OK and high.

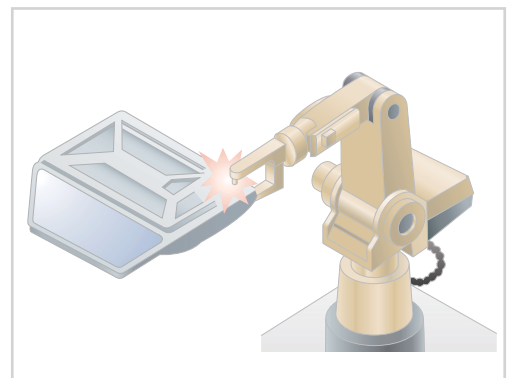

Technical Specifications

Pressure Sensor

Type	Vacuum pressure				Positive pressure			Compound pressure		
	- 101kPa type				1MPa type			±100kPa type		
PN	DPH-A00	DPH-A10	DPH-A20	DPH-A30	DPH-A02	DPH-A12	DPH-A22	DPH-A07	DPH-A17	DPH-A27
Type of pressure	Gauge pressure									
Rated pressure range	0 to -101.3kPa				0 to 1.000MPa			-100.0 to 100.0kPa		
Applicable fluid	Non-corrosive gas									
Supply voltage	12 to 24VDC +10% /-15% Ripple P-P 10% or less									
Analog voltage output	<ul style="list-style-type: none"> • Output voltage: 1 to 5V (over rated pressure range) • Zero point: within 1V ± 2% F.S. (vacuum / positive pressure type) within 3V ± 3% F.S. (compound pressure type) • Span: within 4V ± 3.5% F.S. 									
Pressure port	DPH-A0 □: M5 female thread (for installing gasket), DPH-A1 □: R (PT) 1/8 male thread / M5 female thread DPH-A2 □: NPT 1/8 male thread / 10-32UNF female thread, DPH-A30 : 10-32UNF male thread (for installing gasket),									
Housing material	Enclosure: PBT, Pressure port: Brass (nickel plated) (however, stainless steel (SUS303) in case of DPH-A0 □)									
Connecting method	Connector									
Weight	DPH-A0 □/ DPH-A30 : 6g approx., DPH-A1 □/ DPH-A2 : 10g approx.									
Accessories	Gasket (DPH-A0 □, DPH-A30 only)									

Controller

Type	NPN output type	PNP output type
PN	DP5-C	DP5-C-P
Applicable pressure sensor head	DPH-A00, DPH-A02, DPH-A07, DPH-A10, DPH-A12, DPH-A17, DPH-A20, DPH-A22, DPH-A27, DPH-A30	
Rated pressure range	Vacuum pressure: 0 to -101.3kPa, Positive pressure: 0 to 1.000MPa, Compound pressure: -100.0 to 100.0kPa	
Supply voltage	12 to 24VDC +10% /-15% Ripple P-P 10% or less	
Analog voltage output	<ul style="list-style-type: none"> • Output voltage: 1 to 5V (over rated pressure range) • Zero point: within 1V ± 2.5% F.S. (vacuum / positive pressure type) within 3V ± 3.5% F.S. (compound pressure type) • Span: within 4V ± 4% F.S. 	
Housing material	Front case: ABS, LCD display selection: PET, Rear case: PBT	
Connecting method	Connector	
Weight	20g approx.	
Accessories	Panel mounting bracket (MS-DP-1): 1 set, Connector: 1 set (Housing: 1 pc., Connector pin: 6 pcs.), Pressure unit label: 1 set., Connector cap: 1 pc.	

DP-M



Precisely detects minute differences in pressure levels

Features

■ High accuracy and resolution

Due to differential pressure sensing, the pressure can be set with a high resolution of 0.01kPa.D (1mm H₂O.D) over a pressure range of 0 to 2.00kPa.D (0 to 204mm H₂O.D) and, moreover, the detection accuracy is within 51% F.S.

■ Bright digital display

Three bright red 7-segment LEDs, 12mm high, are incorporated in the compact body.

■ Simple key setting

Initialization or pressure settings can be easily done with key operation while looking at the display.

■ Analog current output (4 to 20mA) incorporated DP-M2A is also available

Technical Specifications

Type	Vacuum pressure	Positive pressure
PN	DP-M2	DP-M2A
Type of pressure	Differential pressure	
Rated pressure range	0 to 2.00kPa.D (0 to 204mmH ₂ O.D)	
Applicable fluid	Non-corrosive gas	
Supply voltage	12 to 24VDC +10% /-15% Ripple P-P 10% or less	
Analog current output	-	<ul style="list-style-type: none"> • Output current: 4 to 20mA (from 0 to 1.96kPa.D (0 to 200mmH₂O.D)) • Zero point: within 4mA ± 12% F.S. • Span: within 16mA ± 3% F.S. • Linearity: within ± 1% F.S.
Ambient temperature	0 to +50°C (No dew condensation), Storage: -10 to +60°C	
Ambient humidity	35 to 85% RH, Storage: 35 to 85% RH	
Pressure port	ø4.8mm resin pipe	
Housing material	Front case: ABS, Rear case: ABS, LED display: Acrylic, Pressure port: PA	
Connecting method	0.18mm ² 3-core oil resistance cabtyre cable, 2m long	0.18mm ² 4-core oil resistance cabtyre cable, 2m long
Weight	75g approx.	

www.panasonic-electric-works.com



You need further information?

Please visit us: www.panasonic-electric-works.com

or call us: **Tel.: +49(0)8024 648-0**

CC Link

Network communication

Features

■ Network communication

With the CC-Link SC-GU2-C communication unit, you can connect to a CC-Link open network, allowing you to monitor or change settings via a PLC, PC, etc.

■ Ultra high-speed response time of 150μs

■ Independent dual outputs and 5 output modes

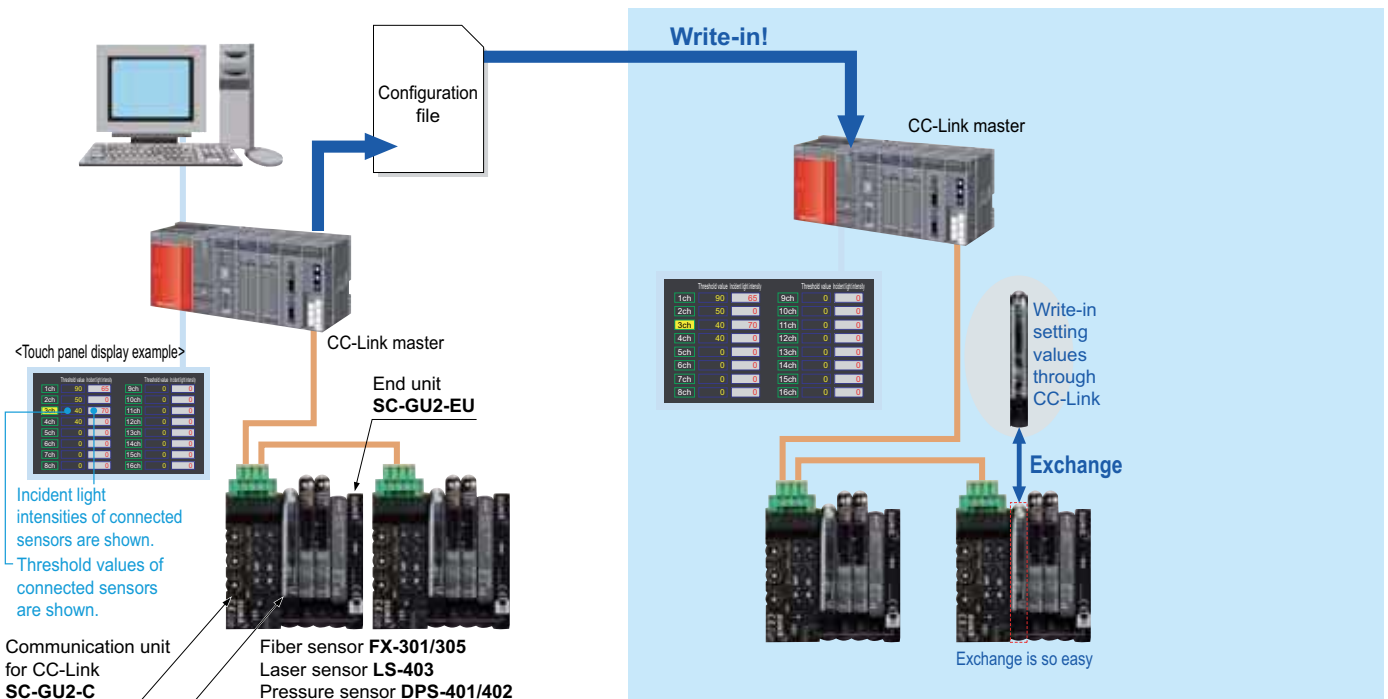

Features

■ Thin controller lineup

The DPS-400 series has answered industry's call to downsize pressure sensors at production sites and conveniently fit into most machines and reduction of man-hours when it comes to replacement.

■ Saves wire and space

Quick-connection cables not only reduce wiring, they reduce the time necessary for setting up relay terminals, and they save space. DPS-400 series controllers can be connected side-by-side with FX-300 series fiber sensors or LS series laser sensors.

■ Current value and threshold value can be checked simultaneously on the dual display

The controller is equipped with a 4-digit dual digital display, which allows you to adjust the threshold value while checking the current value (current pressure value), i.e. it is no longer necessary to switch screen modes.

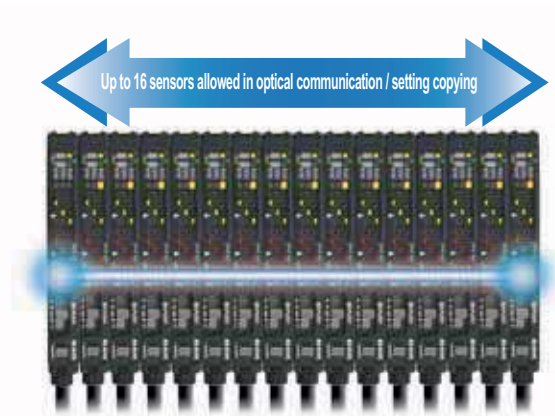
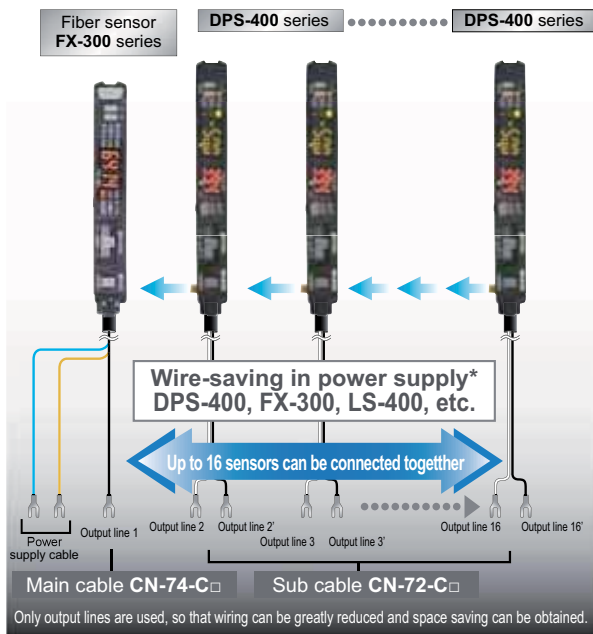

* Check the instruction manual of each model for the arrangement order such when connecting as communication varies depending on the model.

■ Network communication

With the CC-Link SC-GU2-C communication unit, you can connect to a CC-Link open network, allowing you to monitor or change settings via a PLC, PC, etc. Batch communication can even be executed when connected to FX-301/305 series digital fiber sensors or DPS-401/402 series digital pressure sensors.

■ Threshold tracking function

This function tracks changes in the light emitting amount over long periods, such as those caused by dust levels, and threshold values can be reset automatically, helping reduce maintenance costs.



GX-F/H



Industry No. 1 in stable sensing

Features

■ Environmental resistance

■ **10 times the durability!**
(Compared to previous models)

This sensor has the longest stable sensing range among the same level of rectangular inductive proximity sensors in the industry. It is easy to install the sensor.

- Highly resistant to water or oil!
- Can be installed with ample space
- IP68g* protective construction

The new, integrated construction method improves environmental resistance performance.

*The IP68g prevents damage to the sensor by stopping water and oil from getting inside.

■ Indicators are easy to see over a wide field of view

A prism with a wide field of view has been developed, thereby greatly improving the visibility of the operation indicators.

Typical Applications

Checking up/down operation of compact molding equipment



Shock resistance: 5000G

Sensing presence of metallic objects on a part feeder



Vibration resistance: 500Hz

Positioning metal pallets

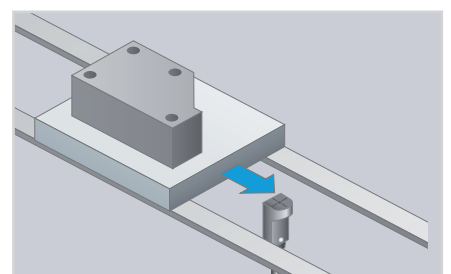

Technical Specifications

Model no.	GX-F8A(I)	GX-F8B(I)	GX-F8A(I)-P	GX-F8B(I)-P
	GX-H8A(I)	GX-H8B(I)	GX-H8A(I)-P	GX-H8B(I)-P
	GX-F12A(I)	GX-F12B(I)	GX-F12A(I)-P	GX-F12B(I)-P
	GX-H12A(I)	GX-H12B(I)	GX-H12A(I)-P	GX-H12B(I)-P
Maximum operation distance (Note 1)	2.5mm \pm 8% GX-□8			
Max. operation distance (Note1)	4.0mm \pm 8% GX-□12			
Supply voltage	12 to 24VDC \pm 15% Ripple P-P 10% or less			
Current consumption	15mA or less			
Output	NPN open-collector transistor <ul style="list-style-type: none"> • Maximum sink current: 100mA • Applied voltage: 30VDC or less (between output and 0V) • Residual voltage: 1V or less (at 100mA sink current) 0.4V or less (at 16mA sink current) 		PNP open-collector transistor <ul style="list-style-type: none"> • Maximum source current: 100mA • Applied voltage: 30VDC or less (between output and 0V) • Residual voltage: 1V or less (at 100mA source current) 0.4V or less (at 16mA source current) 	
Protection	IP68 (IEC), IP68g (JEM) (Note 2, 3)			
Temperature characteristics	Over ambient temperature range -25 to $+70^{\circ}\text{C}$: Within \pm 8% of sensing range at 23°C			
Net weight	Front sensing type: 15g approx., top sensing type: 20g approx.			
Material	Enclosure: PBT, Indicator part: polyester			

GX-S

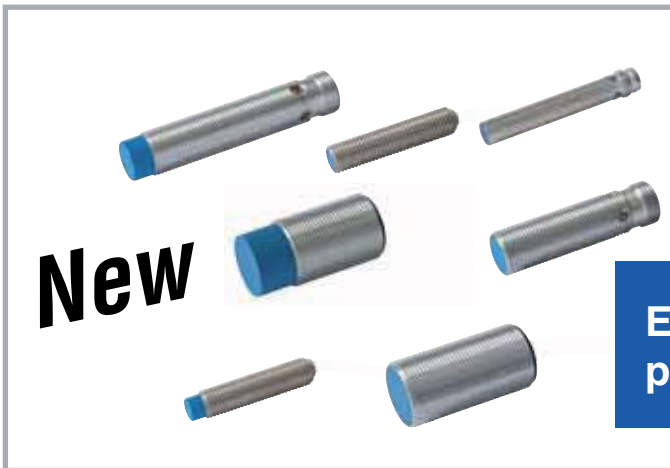

Easy-to-use, cylindrical proximity sensors

Features

■ Variety

- Stainless steel or chrome plated brass housings
- PNP or NPN output
- Cylinder or thread types
- Connection or cable types

■ Cost effective

- With a widely used M8/M12/M18
- Cylindrical shape housing means quick and easy installation

Typical Applications

Controlling depth of drilling

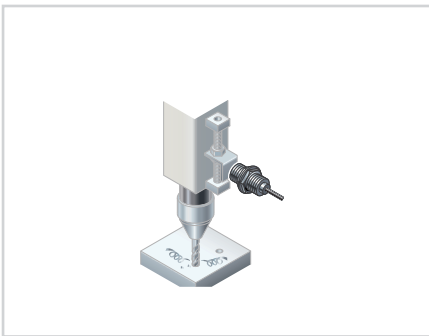

Sensing the punch of a die

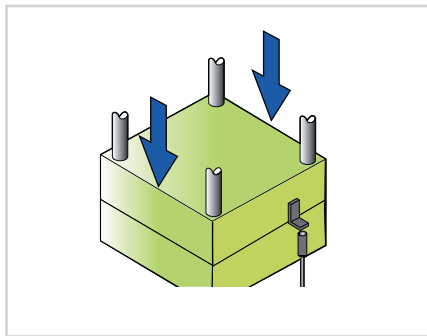

Counting parts

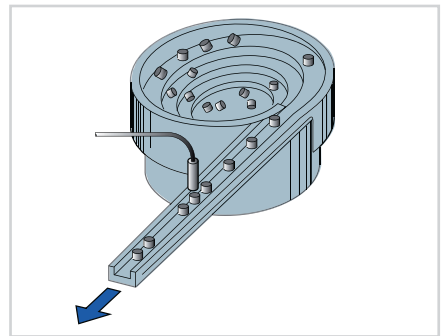

Technical Specifications

	GXS-E015-DV2-(P/)(J/Z/)	GXS-E020-DV2-(P/)(J/Z/)	GXS-E015-CV2-(P/)(J/Z/)	GXS-E020-CV2-(P/)(J/Z/)	GXS-N025-CV2-(P/)(J/Z/)	GXS-E020-BBCS-(P/)(Z/)	GXS-E020-BBC-(P/)(Z/)	GXS-N040-BBC-(P/)(Z/)	GXS-N040-BBCS-(P/)(Z/)
Mounting	Embedable	Embedable	Embedable	Embedable	Non-embedable	Embedable	Embedable	Non-embedable	Non-embedable
Sensor type	Cylinder type	Cylinder type	Thread type	Thread type	Thread type	Thread type	Thread type	Thread type	Thread type
(Ø in mm)	Ø 6.5	Ø 6.5	M8	M8	M8	M12	M12	M12	M12
Maximum operating distance	1.5mm ±10%	2.0mm ±10%	1.5mm ±10%	2.0mm ±10%	2.5mm ±10%	2.0mm ±10%	2.0mm ±10%	4.0mm ±10%	4.0mm ±10%
Stable sensing range	0 - 1.2mm	0 - 1.6mm	0 - 1.2mm	0 - 1.6mm	0 - 2.0mm	0 - 1.6mm	0 - 1.6mm	0 - 3.2mm	0 - 3.2mm
Detection frequency	5kHz	3kHz	5kHz	3kHz	3kHz	3kHz	3kHz	2kHz	2kHz
Standard	Steel	Steel	Steel	Steel	Steel	Steel	Steel	Steel	Steel
Detectable object	6.5x6.5x1mm	6.5x6.5x1mm	8.0x8.0x1mm	8.0x8.0x1mm	8.0x8.0x1mm	12.0x12.0x1mm	12.0x12.0x1mm	12.0x12.0x1mm	12.0x12.0x1mm
Supply voltage	±20%								
Hysteresis	Max. 15% of maximum operating range								
Output transistor	Max. 200mA								
Current consumption	Max. 10mA								
Housing material	Stainless steel					Chrome plated brass			
Protection	IP67								
Connection	J=Connector M8 Z=Connector M12 =cable2m								

P=PNP =NPN J=Connector M8 Z=Connector M12 =cable2m

	GXS-E040-BBC-(P/)(Z/)	GXS-E040-BBCS-(P/)(Z/)	GXS-E050-ABC-(P/)(Z/)	GXS-E050-ABCS-(P/)(Z/)	GXS-N080-ABC-(P/)(Z/)	GXS-N080-ABCS-(P/)(Z/)	GXS-Q080-ABC-(P/)(Z/)	GXS-Q080-ABCS-(P/)(Z/)
Mounting	Embedable	Embedable	Embedable	Embedable	Non-embedable	Non-embedable	Quasi-embedable	Quasi-embedable
Sensor type	Thread type	Thread type	Thread type	Thread type	Thread type	Thread type	Thread type	Thread type
(Ø in mm)	M12	M12	M18	M18	M18	M18	M18	M18
Maximum operating distance	4.0mm ±10%	4.0mm ±10%	5.0mm ±10%	5.0mm ±10%	8.0mm ±10%	8.0mm ±10%	8.0mm ±10%	8.0mm ±10%
Stable sensing range	0 - 3.2mm	0 - 3.2mm	0 - 4.0mm	0 - 4.0mm	0 - 5.4mm	0 - 5.4mm	0 - 5.4mm	0 - 5.4mm
Detection frequency	2.5kHz	2.5kHz	2kHz	2kHz	1.4kHz	1kHz	1kHz	1kHz
Standard	Steel	Steel	Steel	Steel	Steel	Steel	Steel	Steel
Detectable object	12.0x12.0x1mm	12.0x12.0x1mm	18.0x18.0x1mm	18.0x18.0x1mm	24.0x24.0x1mm	24.0x24.0x1mm	24.0x24.0x1mm	24.0x24.0x1mm
Supply voltage	10 to 30VDC ±20%							
Hysteresis	Max. 15% of maximum operating range							
Output transistor	200mA							
Current consumption	Max. 10mA							
Housing material	Chrome plated brass							
Protection	IP67							
Connection	J=Connector M8 Z=Connector M12 =cable2m							

P=PNP =NPN J=Connector M8 Z=Connector M12 =cable2m

GP-X



High-speed sampling 25 μ s and high resolution 0.02% eddy current type

Features

- We have realized a 25 μ s (40,000 times/sec.) ultra high sampling speed
- These devices boast 0.07% F.S./IC temperature characteristics
- They perform with a $\pm 0.3\%$ F.S. linearity for stainless steel and iron

Because they perform with a $\pm 0.3\%$ F.S. linearity, they can be used for sensing stainless steel and iron, enabling precise measurements not affected by the workpiece's material.

- Intelligent monitor GP-XAiM (optional) optimal for collecting and analyzing measurement data

- The 5-digit, dual, 2-color digital display offers great visibility

If the measurement results fall within the setting range (GO), they will appear on the lower digital display in green. If they are out of range (HI, LO), they will be displayed in the upper digital display in orange. The display position and color change permit accurate visibility even for momentary changes.

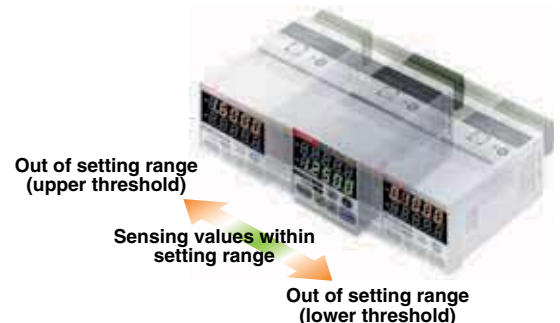

Technical Specifications

Sensor heads

Model no.	GP-X3SE	GP-X5SE	GP-X8S	GP-X10M	GP-X12ML	GP-X22KL
Sensing range	0 to 0.8mm	0 to 1mm	0 to 2mm	0 to 2mm	0 to 5mm	0 to 10mm
Standard sensing object	Stainless steel (SUS304)/iron sheet 60×60×1mm					
Ambient temperature	-10 to +55°C					
Dimensions (mm)	∅3.8×17	∅5.4×17	∅8×17	M10×17	M12×21	∅22×35

Controller

Set model no.	NPN output type GP-XC□, PNP output type GP-XC□-P
Supply voltage	24VDC $\pm 10\%$
Resolution	(64 times average processing): GP-XC3SE/XC5SE 0.04% F.S. GP-XC8S/XC10M/XC12ML/XC22KL 0.02% F.S.
Analog voltage output:	Output voltage 15 to +5V
Comparative outputs (HI, GO, LO)	GP-XC□ NPN open-collector transistor GP-XC□-P PNP open-collector transistor
Dimensions (mm)	W48×H48×D83

HL-G1

New



Introducing the new standard in CMOS laser displacement sensors

Features

■ High resolution of 0.5 μm Fast response Sampling rate 200 μs

Thanks to high-precision measurement at a resolution of 0.5 μm and an LED digital display that provides exceptional ease of use, the HL-G1 series will see use in a variety of applications on production lines worldwide.

■ Fast, compact and user-friendly

Setup is fast and efficient by using the built-in digital display to set measurement parameters such as sampling cycle and output options. The HL-G1 series features a compact design despite its built-in controller and digital readout. Thanks to our miniaturization technology, it can easily be installed on robot arms and in confined spaces. And the series now features a user-friendly interface that offers improved ease of use when operating via computer software or HMI unit for more sophisticated operation and analysis.

■ Featuring 3 digital plus 2 analog outputs

With three outputs, the **HL-G1** can be used to generate HI/GO/LOW judgment output or alarm output. The analog output can be used in both current and voltage modes.

■ Lightweight body that can be used on moving machinery

The sensor weighs 70g and can be installed on moving parts such as sliders and robot arms. The sensor ships standard with flexible cables.

■ Smooth setup changes

Memory switching function
Up to four groups of sensor settings can be stored for fast recall.

■ HMI screen for the HL-G1 series

The GT02 / GT12 HMI touch panel can be used in combination with the HL-G1 to allow easy confirmation of sensor status and configuration of sensor settings from a remote location.

Selection of Panasonic HMI touch panels:

- AIG02GQ 14D
- AIG02MQ 15D
- AIG12GQ 14D/15D
- AIG12MQ 14D/15D



HL-G1 Technical Specifications

	Displacement sensor (standard type)			
Model no.	HL-G103-A-C5	HL-G105-A-C5	HL-G108-A-C5	HL-G112-A-C5
Laser class	2			
Analog output	0 - 10V / 4 - 20mA			
Measurement range	30 ± 4mm	50 ± 10mm	85 ± 20mm	120 ± 60mm
Beam diameter	0.1 x 0.1mm	0.5 x 1mm	0.75 x 1.25mm	1.0 x 1.5mm
Sampling rate	200µs, 500µs, 1ms, 2ms			
Resolution	0.5µm	1.5µm	2.5µm	8µm
Linearity	±/ - 0.1% F.S.			
Laser wavelength	655nm			
Max. power of the emitting element	1mW			
Output transistor	50mA or less (NPN/PNP)			
Material	Enclosure: PBT, Front cover: Acrylic / cable: PVC			
Degree of protection	IP67			
Dimensions (HxWxL)	60 x 57 x 20,4mm			
Connection method	Cable 5m			
Supply voltage	24V DC (±/ -10%)			
Ambient temperature	-10°C to +45°C, storage: -20°C to +60°C			
Ambient humidity	35 to 85% RH, storage: 35 to 85% RH			
Weight (approx.)	320g			

	Displacement sensor (multifunction type)			
Model no.	HL-G103-S-J	HL-G105-S-J	HL-G108-S-J	HL-G112-S-J
Laser class	2			
Analog output	0 - 10V / 4 - 20mA			
Measurement range	30 ± 4mm	50 ± 10mm	85 ± 20mm	120 ± 60mm
Beam diameter	0.1 x 0.1mm	0.5 x 1mm	0.75 x 1.25mm	1.0 x 1.5mm
Sampling rate	200µs, 500µs, 1ms, 2ms			
Resolution	0.5µm	1.5µm	2.5µm	8µm
Linearity	±/ - 0.1% F.S.			
Laser wavelength	655nm			
Max. power of the emitting element	1mW			
Output transistor	50mA or less (NPN/PNP)			
Communication port	RS422 or RS485			
Material	Enclosure: PBT, Front cover: Acrylic / cable: PVC			
Degree of protection	IP67			
Dimensions (HxWxL)	60 x 57 x 20,4mm			
Connection method	0.5 m cable, connector M12			
Supply voltage	24V DC (±/ -10%)			
Ambient temperature	-10°C to +45°C, storage: -20°C to +60°C			
Ambient humidity	35 to 85% RH, storage: 35 to 85% RH			
Weight (approx.)	110g			

Typical Applications

Measurement of actuator part insertion depth

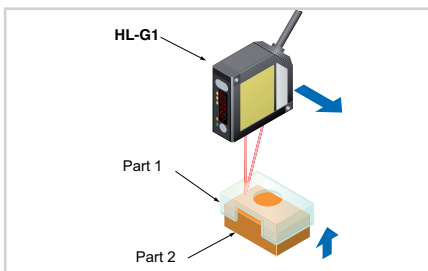

Detection of aluminum wheel grooves

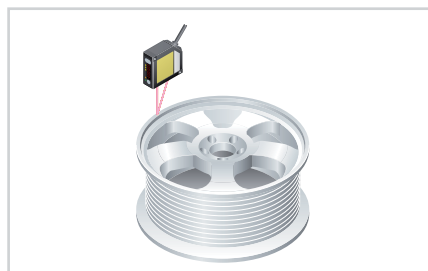

Measurement of sheet thickness

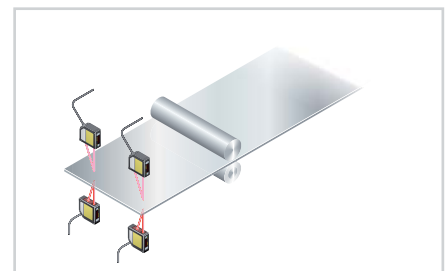

LM-10



The entrance model in μm resolution distance measurement

Features

■ High-precision measurements, comparative output (amount of light) function

In addition to conventional analog output, it is equipped with standard ON/OFF control output (single /double comparator) enabling its use as a photoelectric sensor. It is compatible for 'micro-spotting' and 'high-precision' applications normally reserved for lasers.

■ Laser class 1, visible red light version

The LM-10 series is the newest generation of laser sensors and offers excellent performance. The new single channel technology and the automatic gain adjustment allow high resolution measurements at a wide dynamic range. The LM-10 series is especially suitable for accurate thickness and position measurements.

■ Laser class 2, visible red light version

The LM-10 series also includes a wide range of class 2 sensor heads which offer an even smaller resolution. Also a long distance type with a measuring range from 100mm to 400mm is available. The cable length of all class 2 types is expandable to up to 30m.

■ LCD display for analog values and set points (double comparator type)

In addition to the analog output, the LM-10 controllers have one (single comparator type) or two (double comparator type) set-point judgement outputs. The double comparator type shows the analog values on an LCD.

LM-10 Technical Specifications

Sensor heads

Type	ANR1250	ANR1251	ANR1282	ANR1215	ANR1226
Laser class	2				
Measurement range (mm)	50 ± 10	50 ± 10	80 ± 20	130 ± 50	250 ± 150
Beam dimensions (mm)	0.6 x 1.1	0.09 x 0.05	0.7 x 1.2	0.7 x 1.4	0.8 x 1.5
Response frequency	10/100/1000Hz				
Resolution (µm)	1/3.5/10	1/3.5/10	4/13/40	20/65/200	150/500/1500
Laser wavelength	685nm				
Lasser class	1				
Max. output of laser diode	1.6mW				
Housing material	Zinc die cast				
Degree of protection	IP67				
Size	60 x 60 x 20mm				
Connection method	Connector				
Ambient temperature	0°C to +50°C				
Weight (approx.)	300g				

Controllers

NPN output	ANR5131	ANR5141	ANR5231	ANR5241
PNP output	ANR5132	ANR5142	ANR5232	ANR5242
Type	Single comparator		Double comparator	
Indication	LED		LCD display	
Analog output	±5V, max. 100mA	4 - 20mA	±5V, max. 100mA	4 - 20mA
Evaluation output	Transistor, max. 100mA, 30V DC			
Intensity output	±5V			
Alarm output	Transistor, max. 100mA, 30V DC			
Housing material	Plastic			
Size	35 x 96 x 55mm			
Connection method	Cable			
Operating voltage	12 to 24 V DC (-15% / +10%)			
Ambient temperature	0°C to +50°C			
Weight (approx.)	180g			

Typical Applications

Measuring packing tape thickness

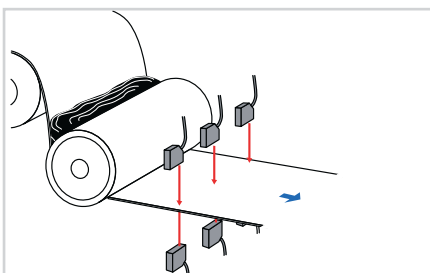

Slack detection

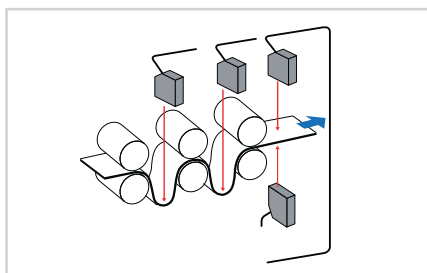

Asymmetry detection

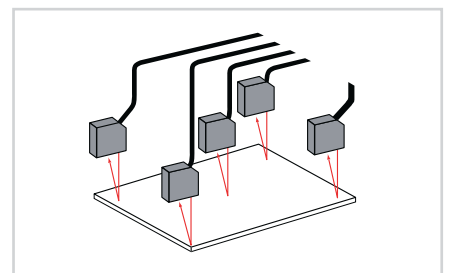

HL-C1



Ultra high-speed & stable measurement for a variety of measurement objects

Features

■ 100μs of sampling rate is now available

The most amazing, ultra high-speed sampling in the industry has now been achieved for displacement sensors utilizing linear image sensors, thus enabling ultra high-speed measurement of rotating, vibrating and moving objects.

■ Resolution of 1μm, linearity of ±0.1% F.S.

Now available with ultra-precise 1μm resolution measurement capability (HL-C105B-BK, HL-C105F-BK, HL-C105B, HL-C105F) and a linearity of ±0.1% F.S. (for all models).

■ Touch panel operation, easy and compact

A variety of setting and measurement data can be displayed easily (optional).



■ High accuracy measurement is now possible, unaffected by the surface condition of the detected object

All deficiencies inherent in the conventional PSD sensing method have now been completely solved. Whereas the PSD method measures position information from the center of gravity of the total light quantity distribution of the light spots connected along each light element, the linear image sensing method measures the peak position values for the light spots themselves. This advance now makes high-precision measurement possible, regardless of the surface condition of the object, whether for metal hairline surface cracks or for non-reflective surfaces, e.g. black rubber.

■ Two sensor heads can be connected! Reduces costs and saves space

■ Controller compact and front connection reduces setup space

The ultra compact controller with dimensions of W40×H120×D74mm requires extremely little space for installation. Adhesive installation is also possible. Furthermore, the cables can be connected directly or to a removable terminal board, so that all connections come from the same direction in order to further save space.

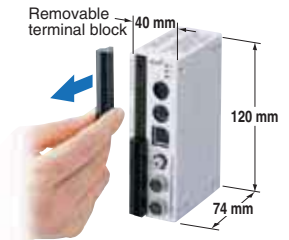

■ Equipped with serial input/output

An RS 232C interface for serial input and output is provided so that settings can be retrieved and saved. Measurement values can also be retrieved.

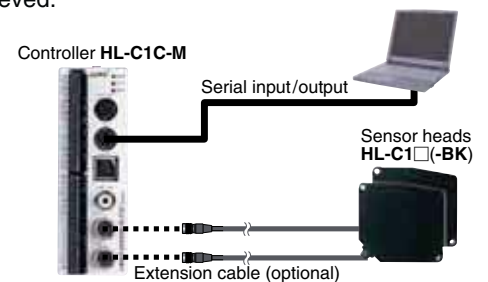

■ FDA standards conforming types are available

■ Special version for measurement of raw and completed rubber tire

The HL-C1 series has added a new line of tire measuring specialized versions for tire making processes.

The high-powered 5mW type enables high accuracy and stable measurement of raw tires and completed tires which were previously considered difficult to measure.

Typical Applications

Measuring glass substrate thickness

The HL-C1 series specular reflective type realizes stable distance measurements even for specular and transparent objects.

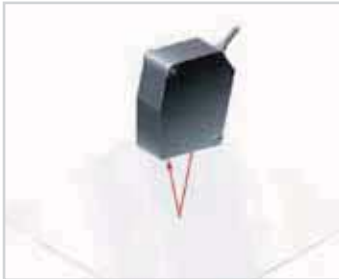

Detecting the presence of a resin coating

The HL-C1 series detects translucent resin coating.

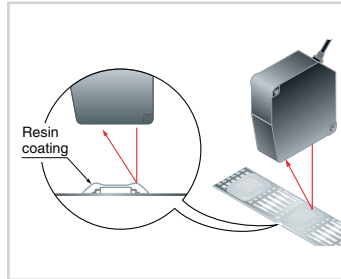

Measuring the eccentricity of a metal shaft

By using the filter function, it can quickly and stably measure even workpieces with tiny scratches.



Technical Specifications

Sensor heads

Type	Diffuse reflective		Specular reflective	
	General propose	High accuracy	General propose	High accuracy
Model no. (Note 1)	HL-C108B(F)-BK	HL-C105B(F)-BK	HL-C108B(F)	HL-C105B(F)
Measurement center distance	85mm	50mm	81.4mm	46mm
Measuring range	±20mm	±5mm	±16mm	±4mm
Resolution (Note 2)	2μm	1μm	2μm	1μm
Linearity	±0.1%F.S.			
Emitting element	Red semiconductor laser, Class 2 (class II for FDA standards conforming type)(IEC/JIS standards conforming type: IEC / JIS, FDA standards conforming type: JIS / IEC / FDA)(Max. output: 1 mW, Peak emission wavelength: 685 nm)			
Beam diameter	100×140μm approx.	70×120μm approx.	100×140μm approx.	70×120μm approx.
Protection	IP67 (excluding connector)			
Ambient temperature	0 to +45°C			
Dimensions (W×H×D)	26.6×82×87mm			

Notes: 1) HL-C10□B(-BK) is IEC/JIS standards conforming type.
HL-C10□F(-BK) is FDA standards conforming type.

2) Where measurement conditions have not been specified precisely, the conditions used were as follows: supply voltage 24VDC, ambient temperature +20°C, sampling rate 100μs, average number of samples: 256, measurement center distance, object measured is made of white ceramic (an aluminum vapor deposition surface reflection mirror was used with specular reflective type). Linearity also depends upon the characteristics of the object being measured.

Controller

Model no.		HL-C1C-M
Connectable sensor head		Max. 2 sensor heads
Supply voltage		24VDC±10%
Sampling rate		Selectable from 100μs/144μs/200μs/255μs/332μs/498μs/1000μs
Analog output	Voltage	Output voltage ±5 V/VS, Output current: Max. 2mA Output impedance: 50 Ω
	Current	Output current: 4 to 20mA/F.S., Load resistance: 250 Ω or less
	Output range	Voltage: 110.9 to -10.9V, Current: 0 to 29.5mA
Judgment outputs (O1, O2)		PhotoMOS relay
Average number of samples		OFF, 2 to 32,768 cycles (switching in 16 steps)
Ambient temperature		0 to +50°C
Dimensions (mm)		W40×H120×D74

HL-C135C-BK10 HL-C1C-M-WL



Superlative wide-range measurement with small head

Features

■ Measures wide changes over long ranges

The long-range and wide-range capabilities over **350mm** $\pm 200\text{mm}$ allow large changes to be measured. Even if the object's position changes, there is no need to change the sensor head settings or position.

■ High-speed and high-precision even over long and wide ranges

High-speed and high-precision measurement is possible with high-speed sampling of **100 μs** at a resolution of **10 μm** and a linearity of $\pm 0.1\%$ F.S.



Sensor heads

Measurement center distance	350mm
Measuring range	$\pm 200\text{mm}$
Emitting element	Red semiconductor laser, Class 3B (IEC/JIS)
Beam diameter	400 \times 200 μm approx.
Controller	Specifications are the same as for the HL-C1C-M controller on the previous page
Dimensions (mm)	W48 \times H48 \times D83

Typical Applications

Measuring brake disk thickness

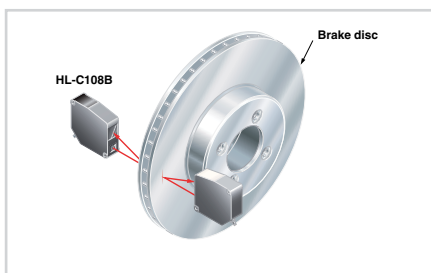

Inspecting tire form



Measuring the thickness of a rubber sheet

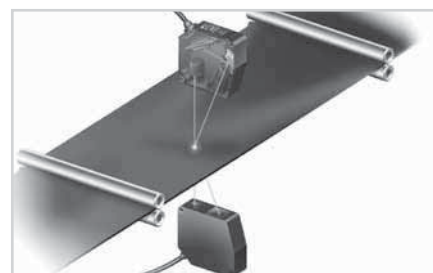

HL-C2



New

Ultra high-speed, precision laser displacement sensors

Features

■ **Excellent basic performance**

■ **10µs sampling rate available**

The HDLC-CMOS sensors have been developed especially for the HL-C2 series. High density light-receiving cells and a processing speed close to the maximum limit result in resolutions and speeds that exceed all expectations for laser displacement sensors.

■ **Resolution up to 0.01µm, linearity up to ±0.02%F.S**

Superior resolution of 0.01µm. Linearity of ±0.02%F.S enabled by latest high resolution lens technology.



■ **Touch panel simplifies operation**

Measurement values and wavelength of the light intensity are displayed. Via the menu, you can set the sensor head function and output conditions.



■ **Compact sensor head saves space**

The volume ratio has been reduced by 23% compared to the previous model, minimizing installation space.



■ **Compact but with a wide array of functions**

You can connect two sensor heads and a variety of devices to the ultra compact controller. Measurement values can be analyzed and displayed while the sensors are being controlled.



■ **Detection tolerance improved for tilted objects**

Detection tolerance for tilted objects has increased by 50% over the previous model, allowing you more flexibility in applications in which the position of the object being sensed fluctuates.

Typical Applications

Measurement of the position of patterned glass

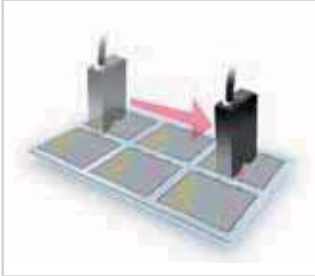

Control of the camera focus



Measurement of the shape of a camshaft



Measurement of the heights of chip parts



Technical Specifications

Model no.	Sensor heads						
	HL-C201F[E]	HL-C203F[E]		HL-C211F[E]		HL-C211F5[E]	
Type	Small beam spot type						
	Specular reflective	Diffuse reflective	Specular reflective	Diffuse reflective	Specular reflective	Diffuse reflective	Specular reflective
Laser class	1	2				3R	
Measuring range	10 ± 1mm	30 ± 5mm	26.4 ± 4.6mm	110 ± 15mm	106.7 ± 14.5mm	110 ± 15mm	106.7 ± 14.5mm
Beam diameter	ø20µm	ø30µm	ø30µm	ø80µm			
Sampling frequency	up to 100kHz						
Resolution	0.01µm	0.025µm	0.25µm	0.1µm	0.25µm	0.1µm	0.25µm
Laser wavelength	658nm						
Max. power of the emitting element	0.1mW	1mW		5mW			
Housing material	Die-cast aluminum						
Protection	IP67						
Physical size (HxWxL)	54 x 95 x 20mm	80 x 70 x 26mm		95 x 54 x 20mm			
Cable	0.5m with connector						
Ambient temp.	0°C to +45°C						
Ambient humidity	35 to 85% RH, Storage: 35 to 85% RH						
Weight (approx.)	250g (including cable)			300g (including cable)			
[E] = Reduced resolution types							

HL-C2 Technical Specifications

Model no.	Sensor heads (linear beam spot type)						
	HL-C201F[E]-MK	HL-C203F[E]-MK		HL-C211F[E]-MK		HL-C211F5[E]-MK	
Type	Linear beam spot type						
	Specular reflective	Diffuse reflective	Specular reflective	Diffuse reflective	Specular reflective	Diffuse reflective	Specular reflective
Laser class	1	2				3R	
Measuring range	10 ± 1mm	30 ± 5mm	26.4 ± 4.6mm	110 ± 15mm	106.7 ± 14.5mm	110 ± 15mm	106.7 ± 14.5mm
Beam diameter	20 x 700μm	30 x 1200μm		80 x 1700μm			
Sampling frequency	up to 100kHz						
Resolution	0.01μm	0.025μm	0.25μm	0.1μm	0.25μm	0.1μm	0.25μm
Laser wavelength	658nm						
Max. power of the emitting element	0.1mW	1mW		5mW			
Housing material	Die-cast aluminum						
Protection	IP67						
Physical size (HxWxL)	54 x 95 x 20mm	80 x 70 x 26mm		95 x 54 x 20mm			
Cable	0.5m with connector						
Ambient temp.	0°C to +45°C						
Ambient humidity	35 to 85% RH, Storage: 35 to 85% RH						
Weight (approx.)	250g (including cable)			300g (including cable)			
[E] = Reduced resolution types							

Model no.	Controllers	
	HL-C2C	HL-C2C-P
Type	Controller (NPN) for up to 2 HL-C2 sensor heads	Controller (PNP) for up to 2 HL-C2 sensor heads
Analog output	±10.8V, 1-25mA	
Outputs	Alarm, judgment, strobe, max. 100mA 30VDC	
Inputs	Timer, zero set, remote interlock, reset 12 to 24VDC	
USB interface	USB 2.0	
Serial input/output	RS-232C (300 - 19.200bps)	
Current consumption	With 1 sensor head: 350mA With 2 sensor heads: 500mA	
Housing material	Die-cast aluminum	
Physical size (HxWxL)	105.5 x 120 x 59mm	
Connection method	Input terminal	
Supply voltage	24VDC (±10%)	
Ambient temp.	0°C to + 50°C	
Temperature characteristics	±0.01% F.S. (25°C)	
Weight (approx.)	450g	

HL-T1

HL-T1



A high-functionality intelligent controller

Features

■ Small sensor head

The most compact size and yet the highest level of performance in their class. These sensors save space.

■ Resolution of 4μm

A high resolution of 4μm (at an average 64 cycles) allows high-precision positioning and size judgment.

■ High-precision measurement even of minute differences in light intensity

The sensors are sensitive to minute differences in light intensity so that they can judge even the opacity of glass and turbidity of liquids. In addition, the amount of light received can be displayed as a percentage to allow you to determine permeation rates.

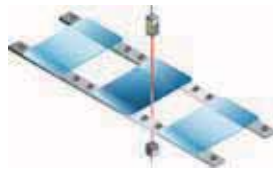

Distinguishing opacity of glass

■ Calculations for 2 sensors are possible

The calculation unit (optional) just needs to be connected between the two controllers to enable calculations (addition and subtraction) to be carried out for two sensors. No digital panel controller is needed.

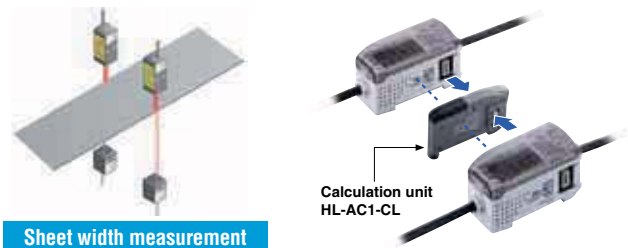

Sheet width measurement

■ FDA standards conforming types are available

FDA standards conforming types, most suitable for equipment used in the USA, are now available (FDA: class II, IEC/JIS: class 1).

Technical Specifications

Sensor heads

Type	Beam diameter Ø1mm type		Sensing width 5mm	Sensing width 10mm type
Model no. (Note 1)	HL-T1001A(F)		HL-T1005A(F)	HL-T1010A(F)
Sensing range	0 to 500mm	500 to 2000mm	500mm	
Sensing width	Ø1mm	Ø1 to Ø2.5mm	5mm	10mm
Min. sensing object	Ø8μm opaque object	Ø50μm opaque object	Ø0.05mm opaque object	Ø0.1mm opaque object
Repeatability (during the state in which light is half blocked)	4μm (Note 2)	—	4μm (Note 2)	
Linear output resolution	4μm (Note 2)	—	4μm (Note 2)	
Ambient temperature	0 to +50°C			
Emitting element	IEC/JIS standards	Red semiconductor laser, Class 1 (IEC/JIS) [modulated, max. output 0.35mW (HL-T1001A(F): 0.2mW), emission peak wavelength: 650nm]		
	FDA standards conforming type	Red semiconductor laser, Class 2 (FDA) [modulated, max. output 0.35mW (HL-T1001A(F): 0.2 mW), emission peak wavelength: 650nm] (IEC/JIS: class 1)		

Notes: 1) HL-T10MA is IEC/JIS standards conforming type.
HL-T10MF is FDA standards conforming type.
2) With an average sampling rate of 64 times.

Controllers

Type	NPN output	PNP output
Model no.	HL-AC1	HL-AC1P
Supply voltage	12 to 24VDC ±10%	
Measuring cycle	150μs	
Linear output	Current / voltage output switchable	
	<ul style="list-style-type: none"> • During current output: 4 to 20mA/F.S., max. load resistance 300Ω • During voltage output: 54V/F.S., output impedance 100Ω (In the monitor focus function, it can also be set at 55V, 0 to 5V, etc.)	
Temperature characteristics	±0.2% F.S./°C	
Settable average sampling rate	1 / 2 / 4 / 8 / 16 / 32 / 64 / 128 / 256 / 512 / 1024 / 2048 / 4096	
Judgment output (HIGH, PASS, LOW)	NPN open-collector transistor	PNP open-collector transistor
Ambient temperature	0 to +50°C	
Dimensions (mm)	W30×H34.3×D64.3	

New



ER-F Series

Low-volume fan type

Features

■ Two exchangeable louvers to suit your needs

- Just simply replace the louver to change configuration between long distance and wide area ionization.
- The two louvers come with the ionizer main body.

■ Remove the louver for effortless maintenance

- Because the discharge needle unit is attached to the louver, exchange or maintenance of the needles is made easy without touching the main unit.
- A safe design where once the louver is removed, the high-voltage circuit and the fan will halt.

Straight louver



Removes charges quickly at long distance

Angle louver



Removes charges completely in wide area



Technical Specifications

Type	Standard fan type	Low-volume fan type
Model no.	ER-F12	ER-F12S
Charge removal time	1 sec. approx. (Note 1)	1.5 sec. approx. (Note 1)
Ion balance	±10 V or less (Note 2)	
Power supply voltage	24 V DC ±10%	
Power consumption	700 mA or less	400 mA or less
Discharge method	High-frequency AC method	
Discharge output voltage	± 2 kV approx.	
Max. fan speed	5.3 m/s (Note 2)	4.0 m/s (Note 2)
Max. fan volume	3.68 m ³ /min	2.50 m ³ /min
Main functions	Error output, Discharge halt input	
Indicators	Discharge error (Red), Fan error (Red), Power (Green), Discharge (Green)	
Ozone generation amount	0.04 ppm or less (Note 1)	
Ambient temperature	0 to +50°C (No dew condensation) / Storage: -10 to +65°C	
Ambient humidity	35 to 65% RH (No dew condensation) / Storage: 35 to 65% RH	
Grounding method	C (capacitor) grounding	
Material	Enclosure: ABS, Louver: ABS, Discharge needle unit: PBT Discharge needle: Tungsten, Bracket: SPHC	
Weight	Main unit: 790 g approx.	
Accessories	Straight louver: 1 pc. (Note 3), Angle louver: 1 pc. Caution label: 1 set, Rubber cushion: 1 pc.	

- Notes: 1) Typical value at 200 mm from directly in front of air outlet, fan speed MAX, straight louver, with no filter installed.
 2) Typical value at 300 mm from directly in front of air outlet, fan speed MAX, straight louver, with no filter installed.
 3) The discharge needle unit is loaded on the straight louver before shipment.

ER-TF

ER-TF



New

Wide-area ionizer

Features

Flexible layout

The air blowing direction can be easily adjusted even after installation.

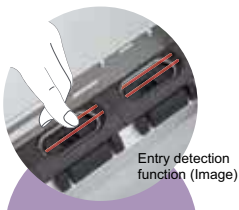

Safe design

Detection of entry to the discharger interrupts the high voltage circuit.

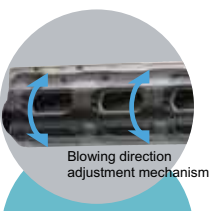

Easy maintenance

Discharge needle units can be detached or attached quickly by sliding open the cover.

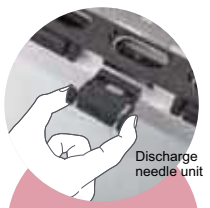

Easy filter cleaning

The fan air intake filter can be easily removed. This greatly reduces the time needed for cleaning.



Airflow can be set to 4 different speeds

Fan can be set to 4 different speeds. The MAX setting quickly removes static charge over a wide area.



The new, wide-area ionizer provides you with a new opportunity to effectively remove static from your production line. ER-TF ionizers are safe in design, easy to maintain and come in a variety of sizes to meet your workstation requirements. Moreover, there is no need for compressed air, which makes installation easy and keeps costs under control.

■ Characteristics of ER-TF series

A style not seen before that pursues performance in cell production lines and resolves dissatisfaction with existing ionizers.

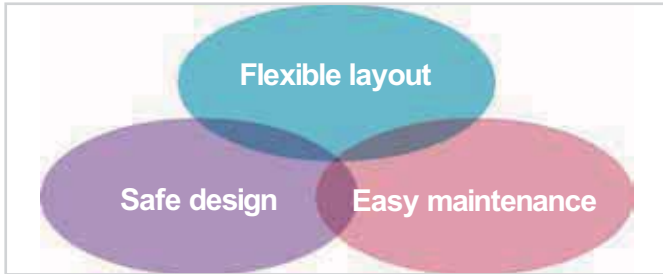

Typical Applications

Desktop setup, 800mm type to accommodate wide workbench

Front setup, 400mm type to suit operation space

Overhead setup, 600mm type to cover cell production

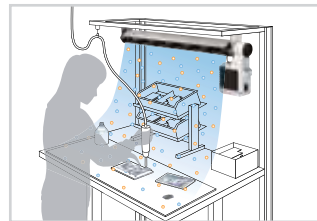
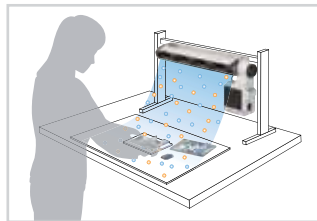
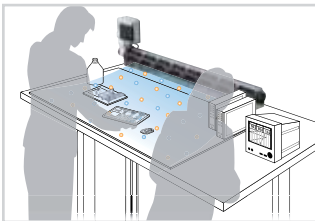

Technical Specifications

Type	Wide-area fan type		
Model no.	ER-TF04-EX	ER-TF06-EX	ER-TF08-EX
Charge removal time ($\pm 1,000V \rightarrow \pm 100V$)	Approx. 1s (Note 1)		
Ion balance	$\pm 10V$ or less (Note 2)		
Supply voltage	Accessory AC adapter input: 100 to 240VAC $\pm 10\%$ 50/60Hz (Output: 24VDC)		
Ambient temperature	0 to + 50°C (No dew condensation), AC adapter: 0 to + 40°C		
Material	Bar unit enclosure: ABS, Fan unit enclosure: ABS, Discharge needles: Tungsten, Mounting bracket: SPCC		
Weight (approx.)	Net weight: 1.0kg	Net weight: 1.2kg	Net weight: 1.4kg

Notes: 1) Typical value at a distance of 200mm from the front surface of the air outlet at the unit center at maximum fan speed.

2) Typical value at a distance of 300mm from the front surface of the air outlet at the unit center at maximum fan speed.

ER-VW



Nozzle angle adjustment and joint layout can be selected as desired

Features

■ Nozzle angle adjustment mechanism

The angles of the two nozzles can be adjusted within a range of approximately 190° by screwing down the ends of the nozzles. After adjusting the angle, turn the ends of the nozzles to tighten them and secure them at that angle. This allows the nozzle angles of the ER-VW to be adjusted easily after installation.

Installation examples

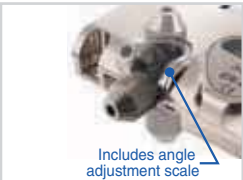
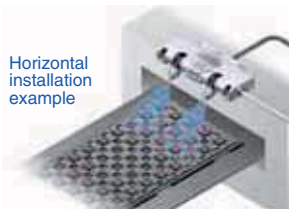
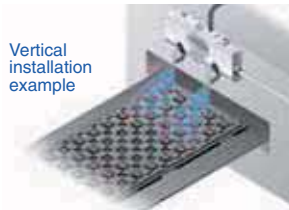

■ Compact and ultrathin design

The thickness of the unit is 18.9mm. Even so, the nozzle angles can be adjusted so that they can still be installed in places where there are space restrictions such as inside other equipment or along several adjacent production lines.

■ Minimum air consumption 15 ℓ/min. (ANR)

ER-VW can utilize air flow levels starting from a minimum of 15 ℓ/min. Because the amount of air consumed is so low, the loads placed on air supply equipment can be reduced and costly clean air can be used much more economically.

Comparison of air consumption

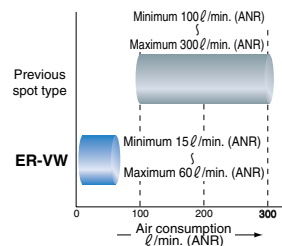

■ Air supply monitoring function

This function causes discharging to stop automatically if the supply of air drops below a certain pressure. Notification of this is given when the AIR indicator lights up and the discharge output (DSC) turns off. This prevents objects which are not charged from being overlooked when the air supply has been stopped.

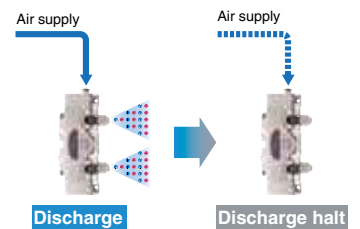

■ Easy connection possible

The joint kit (optional) can be used to connect up to a maximum of 5 ER-VW units. The air supply part is connected via quick connection joints, and the power supply and input/output signals can also be connected easily using connection cables with connectors at both ends.

Multiple ER-VW units can be connected to provide charge removal layouts that suit the target equipment.

Connection application example

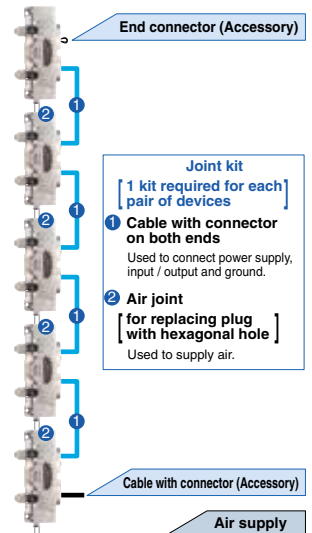

■ Functions to support accurate charge removal

In addition to the air supply monitoring function, the ER-VW is equipped with the following functions to ensure accurate charge removal.



Typical Applications

Removing charge during pickup from dicing type

Ideal for preventing damage to devices from static electricity.

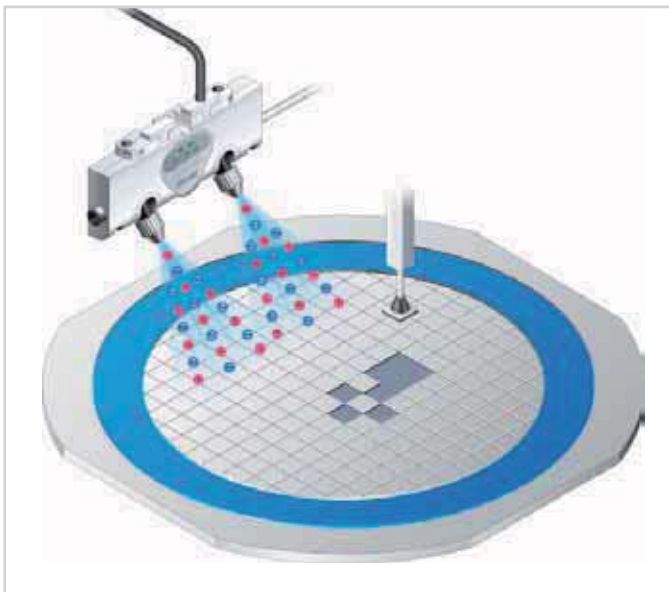

Removing charges from surfaces of CDs / DVDs

Adjustment of the nozzle angle allows the charge removal area to be laid out in accordance with the position of the object.



Type	Spot type
Model no.	ER-VW
Charge removal time ($\pm 1,000V \rightarrow \pm 100V$)	1 sec. or less (Note 1)
Ion balance	Within $\pm 15V$ (Note 1)
Supply voltage	24VDC $\pm 10\%$
Output Check (CHECK) Error (ERROR) Discharge (DSC) (Note 2)	NPN open-collector transistor
Ambient temperature	0 to +55°C

Notes: 1) A typical sample applied with a supply voltage of 24V, a distance of 100mm from the front surface of the air flow outlet and a pressure of 0.25MPa (measured on a sample left in the atmosphere at a relative humidity of 65% RH or less for 24 hours or more).
2) 'DSC' is the abbreviated symbol for 'DISCHARGE'.

ER-V

ER-V



Ultra compact high-performance ionizer

■ **Produces excellent ion balance**

The adoption of high-frequency AC method allows extremely stable ion balance to be achieved. Because the ion balance is not affected by the pressure of air supplied or by the setup distance, no troublesome adjustments are required after setup.

■ **High performance but no controller needed**

A full range of functions have been provided with full consideration given to ease of use in the workplace. No separate controller is needed.

■ **Nozzle variations can be selected to suit the application**



■ **Ultra compact design accurately removes charges of objects even from narrow spaces**

The main unit is merely 109×27×28mm so it can easily be combined with other devices and also be installed as an add-on. Furthermore, the high-voltage power supply is built-in so no extra space is required except for the ionizer itself.

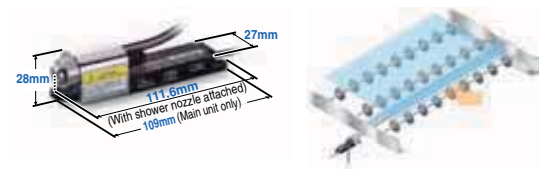

It can be installed in places where the conventional bar type cannot so it can be placed closer to the object for more accurate charge removal.

Typical Applications

Change removal and dust removal of lenses



Prevent discharge damage in circuit board LEDs



Charge removal of FPD glass surfaces

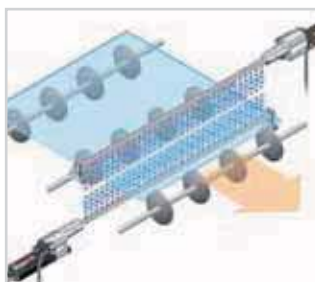

Technical Specifications

Type		Spot type
Model no.		ER-VS01
Charge removal time (±1000V→ ±100V)		1 sec. or less (Note 1)
Ion balance		Within ±15V (Note 1)
Supply voltage		24VDC ±10%
Output	Check (CHECK) Error (ERROR)	NPN open-collector transistor
Ambient temperature		0 to +55°C

Note: A typical sample applied with a supply voltage of 24V, a distance of 100mm from the front surface of the air flow outlet and a pressure of 0.25MPa while the shower nozzle is in use (measured on a sample left in the atmosphere at a relative humidity of 65% RH or less for 24 hours or more).

EC-G



Pulse air-gun ionizer

■ Direct ionized air emission

With the new pulse air-gun ionizer, operators can comfortably neutralize static electricity while manually cleaning.

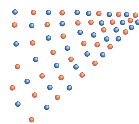

■ Pulsed ionized air

Instant pulse air emission with high air pressure removes dust all at once. The pulse air-gun's light-weight, ergonomic design combined with an oil- and heat-resistant 2m cable make it ideal for flexible use at the production line.

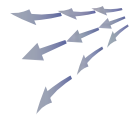

■ White LED illumination

A white LED on the front of the gun illuminates target objects.

Typical Applications

Remove dust on PCB



Remove dust on FPD



Remove dust before painting



Technical Specifications

Model no.	EC-G01
Charge removal time	0.5s or less ($\pm 1,000V \rightarrow \pm 100V$) (Note 1)
Applicable fluid	Air (dried clean air) (Note 2)
Supplied air flow	Max. 300l/min. (ANR) or less
Air pressure range	0.05 to 0.50MPa
Power supply voltage	Accessory AC adapter INPUT: 100 to 240VAC $\pm 10\%$ 50/60Hz (OUTPUT: 24VDC)
Power consumption	30VA or less
Discharge method	High-frequency AC method
Pulse air mode	Pulse 1 (long) / Pulse 2 (short) / CONT (continuous) selectable by switch
Weight	270g approx. (main unit only)

Notes: 1) Typical value for pulse air mode: CONT at 100mm from the front of discharge nozzle at an applied air pressure of 0.50MPa.

2) Dried clean air is the air passing through an air dryer (clearpoint -20°C approx.) and an airfilter (mesh size $0.01\mu\text{m}$ approx.)

EF-S1



Constantly checks static electricity in process lines

Features

■ Maintains and regulates product quality by eliminating static electric damage

The static electricity that can build up in various places in a process line can be monitored constantly so that abnormalities can be prevented before they occur. This makes it possible to determine if damage or malfunctions are being caused by static electricity so that stable product quality can be maintained.

■ Reduces man hours for ionizer inspections

The de-ionizing effectiveness of ionizers can be understood in real-time so that things such as ionizer damage and the replacement period for worn components can be checked objectively, reducing the number of man hours required for inspection and testing.

Sensor head

Type	Spot type
Model no.	EF-S1HS
Sensing range	8.0 to 20.5mm (± 1 kV range) 21.0 to 40.5mm (± 2 kV range)

Controller

Type	Spot type
Model no.	EF-S1C
Supply voltage	24VDC $\pm 10\%$
Display range (Measurement range)	11,000 to 1000 ± 1 kV range 12,000 to 2000 (± 2 kV range)
Judgment output	NPN open-collector transistor
Analog output	Output voltage 1 to 5V Output impedance 100 Ω approx.

Typical Applications

Measuring surface potential when removing BG sheets



Measuring static electric charges in lead frames

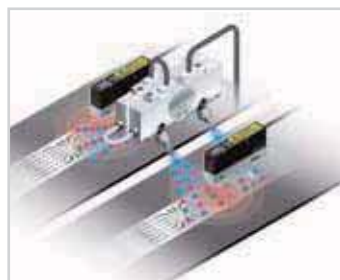

Measuring frictional electrification of LCD modules

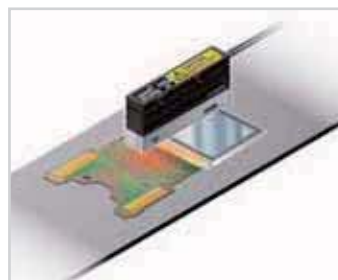

North America

Europe

Asia Pacific

China

Japan

Panasonic Electric Works

Please contact our Global Sales Companies in:

Europe

▶ Headquarters	Panasonic Electric Works Europe AG	Rudolf-Diesel-Ring 2, 83607 Holzkirchen, Tel. +49 (0) 8024 648-0, Fax +49 (0) 8024 648-111, www.panasonic-electric-works.com
▶ Austria	Panasonic Electric Works Austria GmbH	Josef Madersperger Str. 2, 2362 Biedermannsdorf, Tel. +43 (0) 2236-26846, Fax +43 (0) 2236-46133 www.panasonic-electric-works.at
	PEW Electronic Materials Europe GmbH	Ennshafenstraße 30, 4470 Enns, Tel. +43 (0) 7223 883, Fax +43 (0) 7223 88333, www.panasonic-electronic-materials.com
▶ Benelux	Panasonic Electric Works Sales Western Europe B.V.	De Rijn 4, (Postbus 211), 5684 PJ Best, (5680 AE Best), Netherlands, Tel. +31 (0) 499 372727, Fax +31 (0) 499 372185, www.panasonic-electric-works.nl
▶ Czech Republic	Panasonic Electric Works Czech s.r.o.	Průmyslová 1, 34815 Planá, Tel. (+420)-374 799 990, Fax (+420)-374 799 999, www.panasonic-electric-works.cz
▶ France	Panasonic Electric Works Sales Western Europe B.V.	Succursale française, 10, rue des petits ruisseaux, 91370 Verrières Le Buisson, Tél. +33 (0) 1 6013 5757, Fax +33 (0) 1 6013 5758, www.panasonic-electric-works.fr
▶ Germany	Panasonic Electric Works Europe AG	Rudolf-Diesel-Ring 2, 83607 Holzkirchen, Tel. +49 (0) 8024 648-0, Fax +49 (0) 8024 648-111, www.panasonic-electric-works.de
▶ Hungary	Panasonic Electric Works Europe AG	Magyarországi Közvetlen Kereskedelmi Képviselet, 1117 Budapest, Neumann János u. 1., Tel. +36 1 999 89 26 www.panasonic-electric-works.hu
▶ Ireland	Panasonic Electric Works UK Ltd.	Irish Branch Office, Dublin, Tel. +353 (0) 14600969, Fax +353 (0) 14601131, www.panasonic-electric-works.co.uk
▶ Italy	Panasonic Electric Works Italia srl	Via del Commercio 3-5 (Z.I. Ferlina), 37012 Bussolengo (VR), Tel. +39 (0) 456752711, Fax +39 (0) 456700444, www.panasonic-electric-works.it
▶ Nordic Countries	Panasonic Electric Works Nordic AB	Knarrarnäsgatan 15, 164 40 Kista, Sweden, Tel. +46 859476680, Fax +46 859476690, www.panasonic-electric-works.se
▶ Poland	Panasonic Electric Works Polska sp. z o.o	Jungmansgatan 12, 21119 Malmö, Tel. +46 40 697 7000, Fax +46 40 697 7099, www.panasonic-fire-security.com
▶ Portugal	Panasonic Electric Works España S.A.	ul. Wołoska 9A, 02-583 Warszawa, Tel. +48 (0) 22 338-11-33, Fax +48 (0) 22 338-12-00, www.panasonic-electric-works.pl
▶ Spain	Panasonic Electric Works España S.A.	Portuguese Branch Office, Avda Adelino Amaro da Costa 728 R/C J, 2750-277 Cascais, Tel. +351 214812520, Fax +351 214812529
▶ Switzerland	Panasonic Electric Works Schweiz AG	Barajas Park, San Severo 20, 28042 Madrid, Tel. +34 913293875, Fax +34 913292976, www.panasonic-electric-works.es
▶ United Kingdom	Panasonic Electric Works UK Ltd.	Grundstrasse 8, 6343 Rotkreuz, Tel. +41 (0) 41 7997050, Fax +41 (0) 41 7997055, www.panasonic-electric-works.ch Sunrise Parkway, Linford Wood, Milton Keynes, MK14 6 LF, Tel. +44 (0) 1908 231555, Fax +44 (0) 1908 231599, www.panasonic-electric-works.co.uk

North & South America

▶ USA	PEW Corporation of America	629 Central Avenue, New Providence, N.J. 07974, Tel. 1-908-464-3550, Fax 1-908-464-8513, www.pewa.panasonic.com
--------------	-----------------------------------	---

Asia Pacific/China/Japan

▶ China	Panasonic Electric Works (China) Co., Ltd.	Level 2, Tower W3, The Towers Oriental Plaza, No. 2, East Chang An Ave., Dong Cheng District, Beijing 100738, Tel. (010) 5925-5988, Fax (010) 5925-5973
▶ Hong Kong	Panasonic Electric Works (Hong Kong) Co., Ltd.	RM1205-9, 12/F, Tower 2, The Gateway, 25 Canton Road, Tsimshatsui, Kowloon, Hong Kong, Tel. (0852) 2956-3118, Fax (0852) 2956-0398
▶ Japan	Panasonic Electric Works Co., Ltd.	1048 Kadoma, Kadoma-shi, Osaka 571-8686, Japan, Tel. (06) 6908-1050, Fax (06) 6908-5781, http://panasonic-electric-works.net
▶ Singapore	Panasonic Electric Works Asia Pacific Pte. Ltd.	101 Thomson Road, #25-03/05, United Square, Singapore 307591, Tel. (06255) 5473, Fax (06253) 5689